



TENNESSEE DEPARTMENT OF ENVIRONMENT AND CONSERVATION

Division of Water Resources

William R. Snodgrass Tennessee Tower, 312 Rosa L. Parks Avenue, 11th Floor, Nashville, Tennessee 37243
1-888-891-8332 (TDEC)

Notice of Intent (NOI) for General NPDES Permit for Stormwater Discharges from Construction Activities (TNR100000)

Site or Project Name: 1311-1319 Baptist World Center
NPDES Tracking Number: TNR
Street Address or Location: 1311-1319 Baptist World Center
Construction Start Date: 12/21
Estimated End Date: 12*22
Site Description: 15 Residential Units
Latitude (dd.dddd): 36.19550
Longitude (-dd.dddd): 86.78029
County(ies): Davidson MS4 (if applicable): Nashville
Acres Disturbed: 1.0
Check box if a SWPPP is attached: [checked] Check box if a site location map is attached: [checked]
Total Acres: 1.23
Check the appropriate box(s) if there are streams and/or wetlands on or adjacent to the construction site: Streams [] Wetlands []
Has a jurisdictional determination been made by the USACE or EPA identifying waters of the United States?: Yes [] No [checked]
Note: if yes, attach the jurisdictional determination
If an Aquatic Resource Alteration Permit (ARAP) has been obtained for this site, what is the permit number? NR(S)
Receiving waters: Cumberland River

Site Owner/Developer (Primary Permittee): (Provide person, company, or entity that has operational or design control over construction plans and specifications): 1311 BWC PARTNERS, LLC
For corporate entities only, provide correct Tennessee Secretary of State (SOS) Control Number: 001130533
(an incorrect SOS control number may delay NOI processing)

Site Owner or Developer Contact Name: (signs the certification below) Title or Position:
MATT WHITE / CW BUILDING GROUP LLC OWNER
Mailing Address: 4845 MANASSAS DR City: Brentwood State: TN Zip: 37027
Phone: (615) 330-1460 Fax: () E-mail: MATT@CWBUILDINGGROUP.COM

Optional Contact: Title or Position:
Mailing Address: City: State: Zip:
Phone: () Fax: () E-mail:

Owner/Developer(s) Certification: (must be signed by president, vice-president or equivalent, or ranking elected official) (Primary Permittee)
I certify under penalty of law that this document and all attachments were prepared by me, or under my direction or supervision. The submitted information is to the best of my knowledge and belief, true, accurate, and complete. I am aware that there are significant penalties for submitting false information, including the possibility of fine and imprisonment. As specified in Tennessee Code Annotated Section 39-16-702(a)(4), this declaration is made under penalty of perjury.
Owner/Developer Name (print/type): MATT WHITE Signature: [Signature] Date: 11/23/21
Owner/Developer Name (print/type): Signature: Date:

Contractor Certification: (must be signed by president, vice-president or equivalent, or ranking elected official) (Secondary Permittee)
I certify under penalty of law that I have reviewed this document, any attachments, and the SWPPP referenced above. Based on my inquiry of the construction site owner/developer identified above and/or my inquiry of the person directly responsible for assembling this NOI and SWPPP, I believe the information submitted is accurate. I am aware that this NOI, if approved, makes the above-described construction activity subject to NPDES permit number TNR100000, and that certain of my activities on-site are thereby regulated. I am aware that there are significant penalties, including the possibility of fine and imprisonment for knowing violations, and for failure to comply with these permit requirements. As specified in Tennessee Code Annotated Section 39-16-702(a)(4), this declaration is made under penalty of perjury.
Contractor name, address, and SOS control number (if applicable): Signature: Date:

OFFICIAL STATE USE ONLY
Received Date: 12.7.21 Reviewer: Field Office: Permit Tracking Number: TNR 245611 Exceptional TN Water:
Fee(s): T & E Aquatic Flora/Fauna: SOS Corporate Status: Waters with Unavailable Parameters: Notice of Coverage Date:

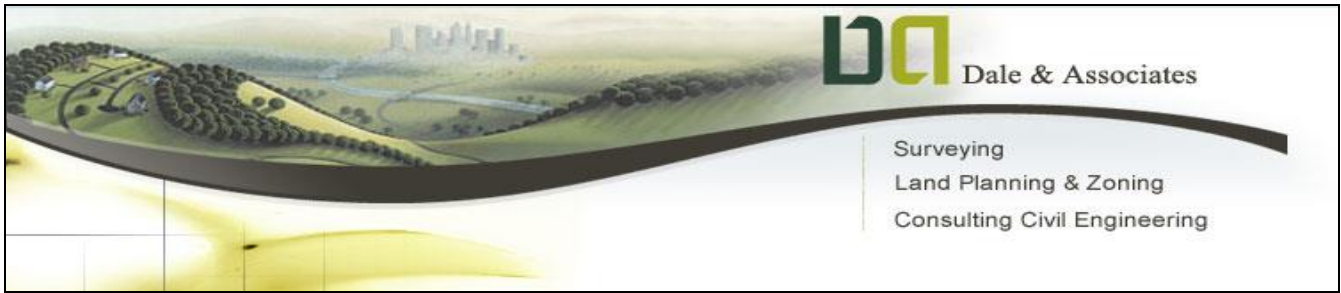

STORM WATER POLLUTION PREVENTION PLAN
(1311-1319 Baptist World Center.)

SWPPP Requirements

- 1.1. Has the SWPPP template been prepared by an individual that has the following certifications (3.1.1) Yes No (check all that apply below)
- 1.1.1.1. Certified Professional in Erosion and Sediment Control (CPESC); or
- 1.1.1.2. TDEC Level II
- 1.2. Do the EPSC plans involve structural design, hydraulic, hydrologic or other engineering calculations for EPSC structural measures (sediment basins, etc.)? Yes no (3.1.1)
- If yes, have the EPSC plans been prepared, stamped and certified by a Licensed Professional Engineer or Landscape Architect?
- Yes No
- 1.3. Do the project stormwater outfalls discharge into the following? yes no (check all that apply below)
- 1.3.1. Impaired waters (303d for Siltation or Habitat Alteration)
- 1.3.2. Tennessee known Exceptional Waters
- If yes, have the EPSC plans been prepared by an individual who has completed TDEC Level II? Yes No n/a ; and
- If yes, has the SWPPP Template been prepared by an individual who has completed TDEC Level II? Yes No n/a

Site Assessments

Quality Assurance Site Assessments of Erosion Prevention and Sediment Controls required:
 yes no

A. SITE INFORMATION

1. Project Description:

The proposed site area is 2.47 ac, located at 1311-1319 Baptist World Center. Nashville, TN Metro Map 71-14, Parcels 99, 100, 103, 1E00200CO, 1E90000CO, 1F00100CO, 1F00200CO & 1F90000CO per the Davidson County Tax Assessor). The purpose of the document and its associated Notice of Intent is for the disturbance 0.99 acres in order to construct a single family residential development (and its associated infrastructure.)

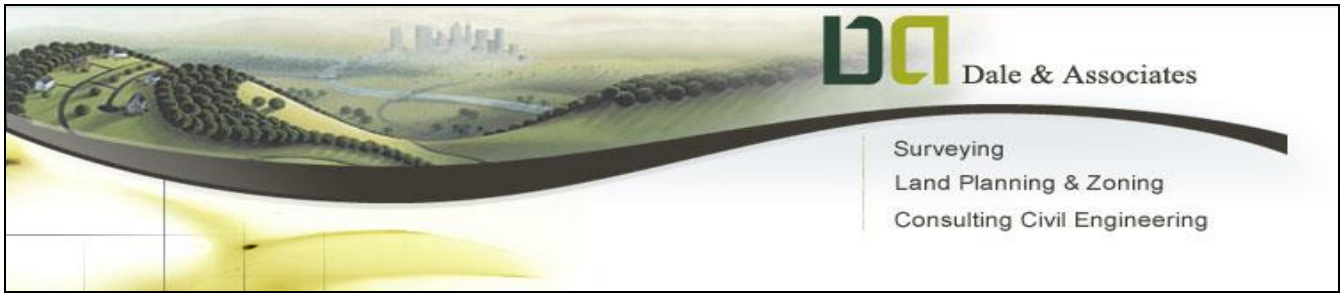

This Storm Water Pollution Prevention Plan has been drafted to serve as a supporting document to the Notice of Intent it is being filed with.

- a. **Area of Coverage Description:** Site area is 0.99 acres.
- b. **Proposed Area of Coverage:** The total area of disturbance proposed through this document is 0.99 acres and is depicted by the heavy contour lines shown on the attached plan. This project does not propose greater than 50 acres of disturbance at any time
- c. **Construction Sequence:** The sequence of major activities that will entail the disturbance of soils within the site include the following in this order: installation of erosion control measures, tree removal, mass grading, instillation of stormwater infrastructure and public utilities, final grading of roads, paving of roads, final site stabilization.
- d. **Topographic Information:** The existing topography within the areas of disturbance is moderate, ranging from 5-15%. Any proposed grading that results in a 3:1 slope is to be stabilized using erosion control matting, as shown on the plans attached to this SWPPP.
- e. **Soil Information:** A copy of the NRCS Soil Survey maps for this site have been attached with to this document and shows this area consisting of Class 'B', soils such as McB.
- f. **Runoff Coefficient Information:** The composite runoff coefficient (c) for this site as a whole after construction is complete will be approximately 0.5 (based on the Rational Method for determining peak discharge, $Q=ciA$ where c is the runoff coefficient). Prior to the initial disturbance, the site consisted of undeveloped heavily vegetated woodlands.
- g. **Limits of Disturbance and Proposed Measures:** Please refer to attached construction plans for proposed measures for erosion prevention and sediment control. The area to be disturbed is shown on the approved grading plans by solid contours, and the dashed and/or shaded contours represent existing ground and areas to remain undisturbed. An Overall Disturbance Boundary can also be found on the plans.
- h. **Stream Disturbance (ARAP Requirement):** None
- i. **Receiving Waters Information:** The receiving water for this site Cumberland River.

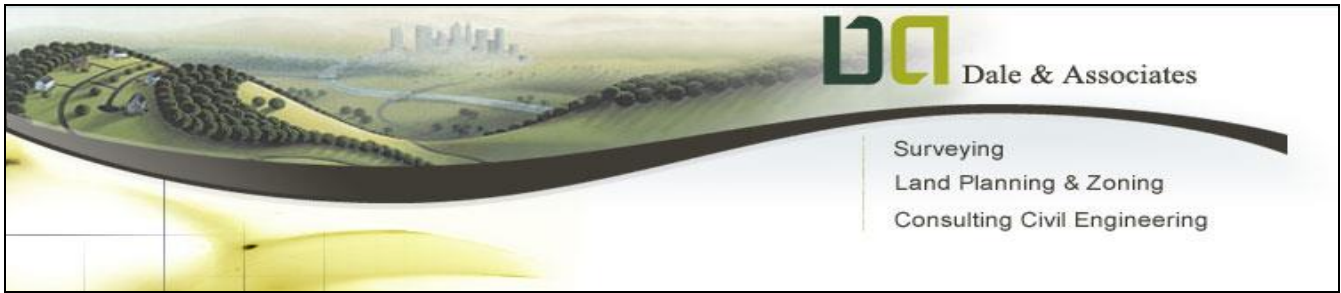

- j. Stream Buffer information:** No stream buffers.
- k. Outfall Information (Sediment Basin Requirement):** The site is up into one basin. All of the site infiltrates via proposed bioretentions.
- l. Post Construction Coverage Requirements:** None
- m. Discharge Information:** There will be no discharge associated with industrial activity other than construction storm water that originates on site as permitted.

n. Wetland Buffers: N/A

o. 2. Outfall and Basin Information:

The site is one basin. An outfall is labeled as 2.47 acres. Most of the proposed site will infiltrate using bioretentions. Infiltration test have been performed on the site to have adequate infiltration rates.

3. Order of Construction Activities:

Infrastructure

- a.** Install stabilized construction entrance.
- b.** Prepare temporary parking and storage area.
- c.** Construct the silt fences, straw bale barriers (revise as construction progresses).
- d.** Clear, grub and grade the site.
- e.** Install temporary sediment control (revise as construction progresses).
- f.** Temporarily seed denuded areas.
- g.** Prepare site for paving and install utilities.
- h.** Install storm drainage and pave streets
- i.** Complete final grading and install permanent seeding or sod.
- j.** Remove all temporary erosion and sediment control devices (only if site is stabilized). The site is stabilized when all soil-disturbing activities are completed and a uniform perennial vegetative cover with a density of 70% of the cover for unpaved areas and areas not covered by permanent structures has been employed.

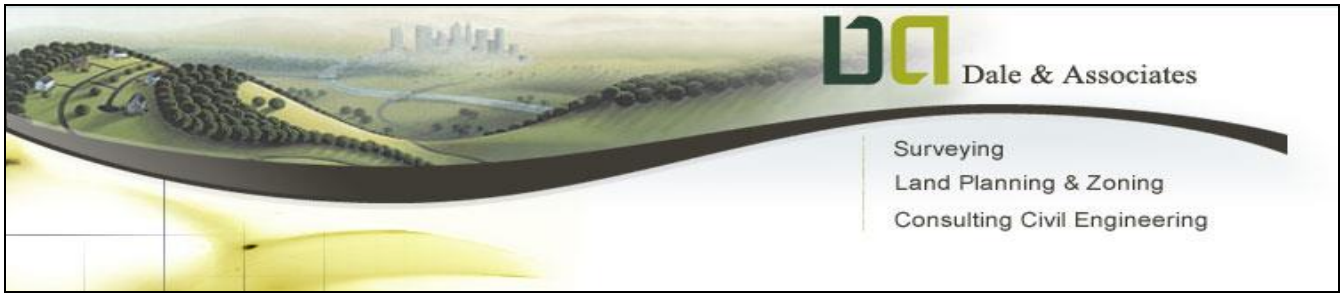

Note: The contractor shall be responsible for implementing, restoring, and/or revising the temporary sediment and erosion control measures (silt fences, straw bale barriers, temporary diversion dikes, etc.) as necessary during construction to help prevent soil erosion and storm water pollution

B. CONTROLS

1. Erosion and Sediment Controls

Contractor is responsible for maintenance and operation of all EPSC Controls for this project. Contractor to maintain all controls per EPSC recommendations or as needed to prevent silt from leaving the site.

- a. *Stabilization Practices.* The vegetation within the scope of the project site development will be removed with the exception of those trees to remain. The areas in which no disturbance shall be allowed are shown on the Grading and Erosion Control Plan. When deficient soil is encountered, soil undercutting will be required in those areas as recommended by the geotechnical report.
 - 1. Where the initiation of stabilization measures by the 14th day after the construction activity temporarily or permanently ceases is precluded by snow cover, stabilization measures shall be initiated as soon as practicable thereafter.
 - 2. Where construction activity will resume on a portion of the site within 15 days from when activities ceased, then stabilization measures do not have to be initiated on that portion of the site by the 14th day after construction activity temporarily ceased.
- b. *Structural Practices.*
 - 1. *Silt Fence.* Silt fences shall be placed and “constructed in accordance with the Erosion Control Plans, see attached sheet.
 - 2. *Hay Bale Barriers.* Hay bale barriers shall be placed and constructed in accordance with the Erosion Control Plans, see attached sheet.
 - 3. *Ditch Check Dams.* Ditch check dams shall be placed and constructed in accordance with the Erosion Control Plans, see attached sheet.

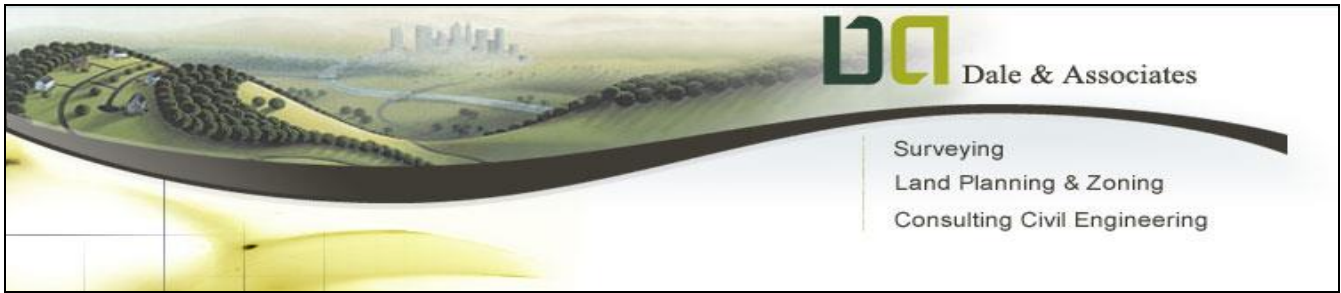

4. *Inlet Protection.* Inlet sediment barriers shall be installed at storm water inlets in accordance with the Erosion Control Plans, see attached sheet. These inlet protection devices shall be implemented as soon as the storm water inlets are constructed.
5. *Rock Outlet Protection.* Hand placed rip-rap pads shall be provided at discharge points in accordance with the Erosion Control Plans, see attached sheet. These riprap pads shall be placed as soon as practical.
6. *Construction Entrance.* Construction entrances should be placed and constructed in accordance with Erosion Control Plans. See attached sheet.
7. *Sediment Basins.* One sediment basin has been designed per the guidelines in the ST-1 to ST-5 section of the Tennessee Erosion & Sediment Control Handbook and shall be installed in accordance with the Erosion Control Plans, see attached sheet.

2. Storm Water Management

- a. Off-site runoff basically continues to flow in its pre-developed state via natural contours. Silt fences have been placed to accommodate runoff associated with a 5-year 24 hour storm event for the Nashville, TN area (approximately 4").
- b. Soil Stabilization will be accomplished by the use of seeding in the appropriate areas, as specified. Temporary seeding will be required in those areas that consist of disturbed soils that have remained dormant for periods of more than 15 days.

As a general rule, permanent seeding will be performed within 14 days after the final grade once an area has been established. If disturbed areas on-site are to remain dormant for periods greater than six months in duration, the contractor will apply permanent soil stabilization. An allowance in the time schedule will be made for snow cover during periods of construction downtime. Seeding will be performed by hydro-seeding, by hand, or by a mechanical broadcasting method

- c. The areas to be seeded will be uniform and will conform to the finished grade and cross Section shown in the plans for this project or as otherwise designated. Owner's representative will perform minor shaping of uneven

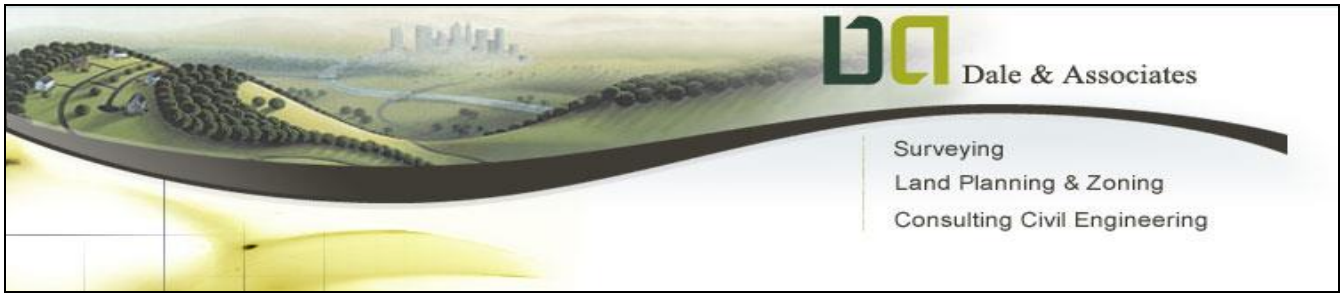

and rough areas outside the graded section as directed in order to provide for more effective erosion control and for ease of subsequent earth moving operations.

- d.** The seed bed (including cut slopes) will be loosened to a minimum depth of 3 inches before agricultural lime, fertilizer or seed is applied. The areas to be seeded will be cleared of stones larger than 2.5 inches in dimension, roots, and other debris.

3. Other Controls

- a.** All contractors and subcontractor affiliated with the construction project shall abide by federal, state (Tennessee), and local (Davidson County) requirements for construction, waste disposal, sanitary sewer, and septic system regulations.
- b.** Providing a construction entrance as detailed on the Erosion Control Plan shall minimize off-site vehicle tracking of sediments. No access for construction ingress or egress shall be allowed except for the construction entrance shown on the Erosion Control Plan.
- c.** *Temporary Parking and Storage.* The temporary parking and storage areas shall be located as determined by developer's construction manager. The temporary parking and storage area shall also be used as the equipment maintenance area, equipment cleaning area, employee break area and area for locating portable facilities, office trailers and toilet facilities.
- d.** *Dust Control.* Dust control on the site shall be minimized by sprinkling water on dry area of the site. The use of motor oils and other petroleum based or toxic liquids for dust suppression operations are prohibited.
- e.** *Construction Waste.* All construction waste and trash (paper, plastic, wood, scrap metals, rubber, etc.) shall be collected and stored in containers with lids or covers that can be placed over the container prior to rainfall. This waste shall be disposed of according to state and local solid waste management regulations.
- f.** *Hazardous Waste.* All hazardous waste (paints, acids for cleaning masonry surfaces, cleaning solvents, concrete curing compounds and additives, etc.) shall be disposed of according to local, state and federal regulations.

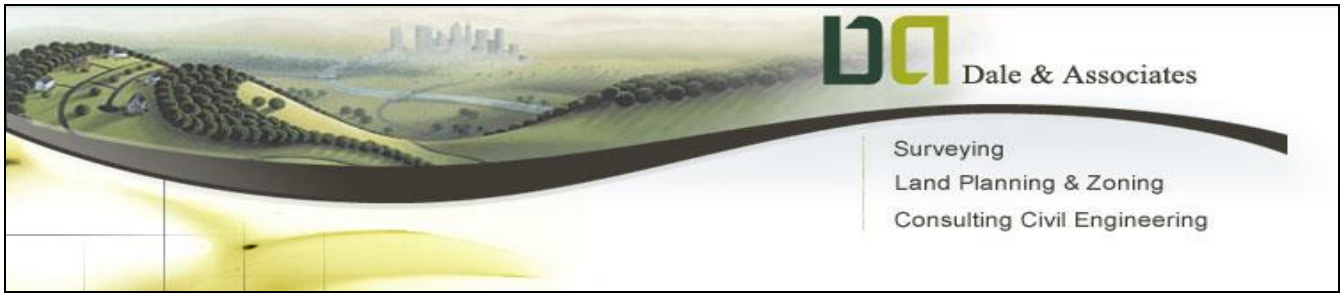

- g.** *Sanitary Waste.* Sanitary waste that is generated on the site shall be disposed of in accordance with local and state regulations.
- h.** *Concrete Truck Waste.* Excess concrete and wash water shall be disposed of in a manner that prevents contact between these materials and storm water that is discharged from the site.
- i.** *Vehicle and Equipment Cleaning.* Wash water generated from vehicle and equipment cleaning shall be disposed of in a manner that prevents contact between these materials and storm water that is discharged from the site.

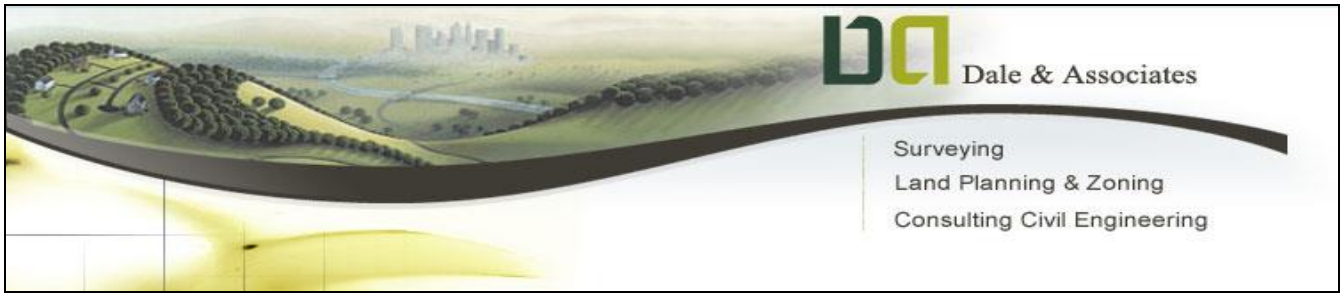

C. MAINTENANCE

1. Maintenance Requirements:

All measures stated in this Storm Water Pollution Prevention Plan and on the Erosion Control Plans for the prevention of storm water pollution and erosion control shall be maintained in fully functional condition until the final stabilization of the site. All erosion and sedimentation control measures shall be cleaned and repaired in accordance with the following, see attached sheets for construction details. Certain features as specified below to remove silt at 50% design capacity.

- a. Erosion Eels shall be fixed or replaced if they show signs of undermining or deterioration.
- b. All seeded areas shall be checked regularly to see that a good stand of grass is maintained. Areas should be reseeded and fertilized as needed to provide a good stand of grass for erosion control.
- c. Silt fences shall be repaired to their original conditions if damaged. Sediment shall be removed from the silt fences when it reaches one-third to one-half the height of the silt fence.
- d. The construction entrances shall be maintained in a condition, which will prevent tracking or flow of mud onto public rights-of-way. This may require periodic top dressing as conditions demand.
- e. The temporary parking and storage area shall be kept in good condition, suitable for parking and storage. This may require periodic top dressing as conditions demand.

The project supervisor/contractor may delegate an individual and/or consultant to sign EPSC Inspections Reports. For satisfying signatory requirements for EPSC Inspection Reports, the project supervisor/contractor and newly authorized individual accepting responsibility must submit written authorization to the local TDEC EFO.

2. Maintenance Practices

- a. All controls will be maintained in good and effective operating order. Necessary repairs or maintenance will be accomplished before the next storm event and in no case more than 7 days after the need is identified. In

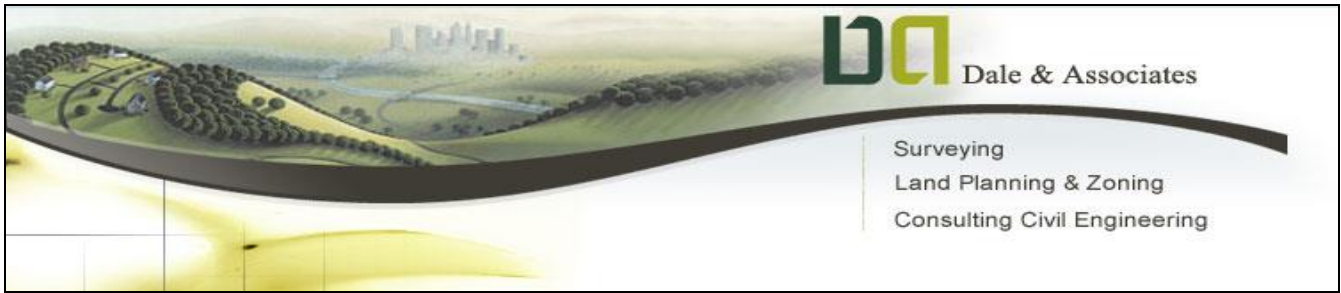

a case where the activity is deemed impracticable, any such conditions will be documented

- b. All controls will be maintained in accordance with standard drawings and good engineering practices.
- c. Sediment will be removed from sediment traps, silt fence, sediment basins, and other controls when the design capacity has been reduced by 50%.
- d. Check dams will be inspected for stability. Sediment will be removed when depth reaches one-half ($\frac{1}{2}$) the height of the dam.
- e. Litter, construction debris, and construction chemicals exposed to stormwater will be picked up and removed from stormwater exposure prior to anticipated storm events or before being carried off of the site by wind, or otherwise prevented from becoming a pollutant source for stormwater discharges. After use, materials used for erosion control will be removed.
- f. All seeded areas will be checked for bare spots, erosion washouts, and vigorous growth free of significant weed infestations.

The project supervisor or their designee and the contractor's site superintendent are responsible for inspections. Maintenance and repair activities are the responsibility of the contractor. The project supervisor or their designee will complete the inspection reports and distribute copies per the contract

D. MATERIAL MANAGEMENT

1. **Petroleum Products:** All on-site vehicles shall be monitored for leaks and receive regular preventative maintenance to reduce the chance of leakage. Petroleum products (oils, gasoline, lubricates, asphalt substances, etc.) shall be stored in tightly sealed containers which are clearly labeled. Any asphalt substances used on-site will be applied according to the manufacturer's recommendations.
2. **Paints:** All containers shall be tightly sealed and stored when not required for use. Excess paint shall not be discharged to the storm sewer system but will properly disposed of according to manufacturer's instructions or state and local requirements.
3. **Fertilizers:** Fertilizers used shall be applied only in the minimum amounts recommended by the manufacturer. Once applied, fertilizer shall be worked into the soil (4 to 6 inches) to limit exposure to storm water. Fertilizers shall be stored in a covered area.
4. **Hazardous Products:** Products shall be kept in original containers unless they are not resealable. Original labels and material safety data shall be retained (the

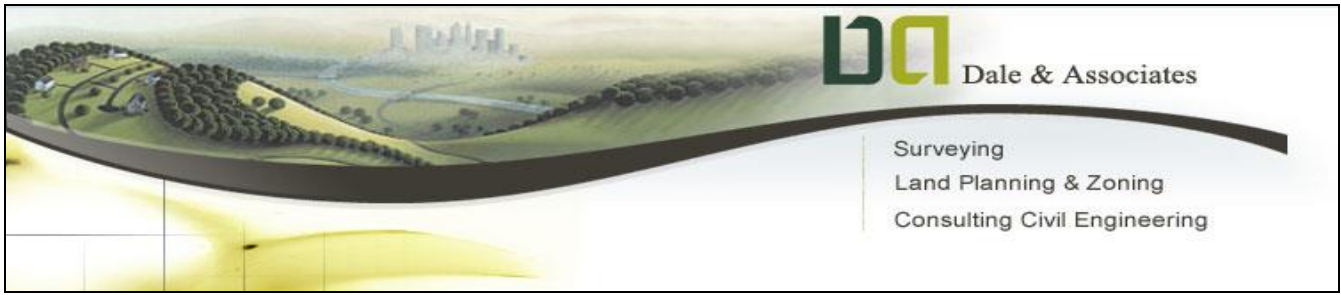

labels contain important product information). If surplus products must be disposed of, local, state and federal requirement shall be followed.

E. SPILL CONTROL PRACTICES

1. Materials shall be tightly sealed in containers that are clearly labeled and shall be neatly and securely stacked.
2. Materials and equipment necessary for spill cleanups shall be kept in the material storage area on-site.
3. All spills shall be cleaned up immediately after discovery.
4. The spill area shall be kept well ventilated and personnel shall wear appropriate protective clothing to prevent injury from contact with a hazardous substance.
5. Spills of toxic hazardous materials shall be reported to the appropriate local, state, and federal government agencies as soon as possible, regardless of the size.
6. Contaminated materials shall be disposed of according to local, state, and federal requirements.
7. One person shall be selected to be the spill prevention and cleanup coordinator.
8. The designated field supervisor will contact the appropriate authorities for notification of a spill related incident. The following list are the authorities as related to this project:

EGH Land Development Inc.	(865)310-0896
Tennessee Department of Environment and Conservation	(615) 532-0625
National Response Center	800-424-8802
Tennessee Emergency Management Agency Non-emergencies	800-262-3300 800-262-3400

Spill of toxic, hazardous, or petroleum-based materials shall be reported immediately to the DPC&E and the local Fire Department.

The Developer will maintain a map outlining the route to the hospital in case of a spill related injury. This map will be posted at each on-site office trailer. A first aid kit will also

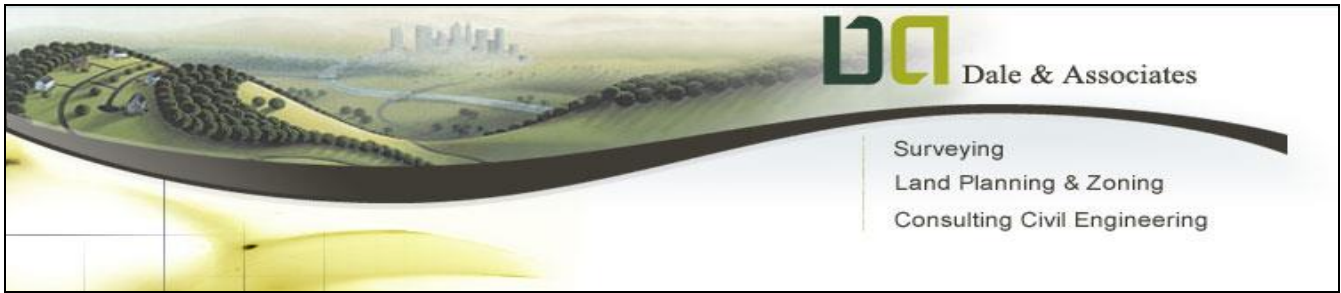

be maintained at the office trailer located on the project site. The Developer will be responsible for ensuring that the kit is complete at all times.

The Developer shall follow the reporting guidelines stated in the state guidelines, if the spill consists of a hazardous or oily substance. Reporting will be in accordance to the provisions stated under 40 CFR Parts 110, 117 and 302.

F. GOOD HOUSEKEEPING

1. The following good housekeeping practices shall be followed on-site during the construction project.
 - a. Neat and orderly storage of any chemicals, fertilizers, fuels, etc., that are being stored on the site.
 - b. Regular garbage, rubbish, construction waste and sanitary waste disposal.
 - c. Prompt cleanup of any spills that have occurred.
 - d. Cleanup of sediment that has been deposited off of the site by vehicle tracking, wind, and storm water.

G. INSPECTIONS

1. Qualified personnel (provided by the contractor) shall inspect all erosion, sedimentation and storm water pollution devices stated in this Storm Water Pollution Prevention Plan and on the Erosion Control Plans at least twice every seven calendar days. Disturbed areas and areas used for material storage that are exposed to precipitation shall be inspected for evidence of, or the potential for, pollutants entering the drainage systems. Erosion and sediment control measures identified in the Storm Water Pollution Prevention Plan and the Erosion Control Plans shall be observed to ensure that they are operating correctly. Discharge locations shall be inspected to ascertain whether the erosion and sedimentation control measures are effective in preventing significant impacts to receiving waters.

Based on the results of the inspections, the erosion and sedimentation control measures shall be revised or modified as appropriate, but in no case shall it take more than seven calendar days following the inspection to revise or modify the erosion and sediment control measures.

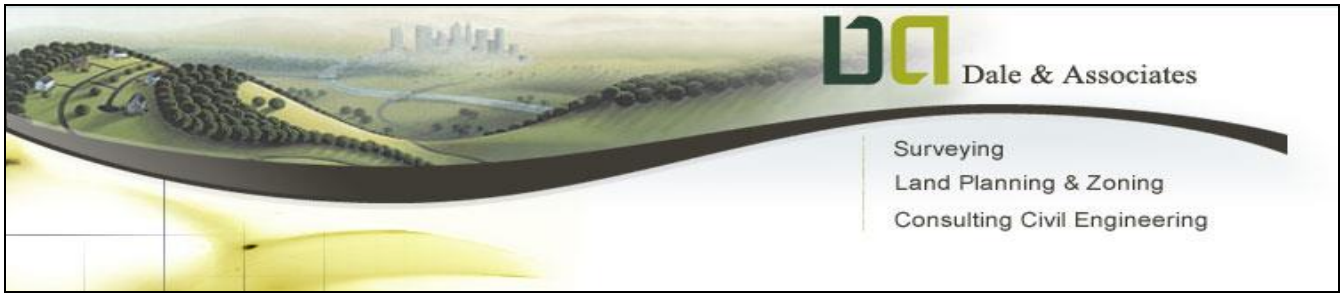

2. Inspection practices

- a. Inspectors must have successfully completed the TDEC Fundamentals of Erosion and Sediment Control Course (TDEC Level I) and maintain the certification. A copy of the inspector's certification should be kept on site.
- b. Inspections will be conducted at least twice every calendar week and at least 72 hours apart.
- c. The frequency of EPSC inspections may be reduced to once a month (i.e. extreme drought conditions, frozen ground, etc.) With written notification to the local environmental field office and subsequent tdec approval. Written notification must include the intent to change frequency and justification.
- d. All disturbed areas of the site that have not been finally stabilized, areas used for material storage that are exposed to precipitation, structural control measures, and locations where vehicles enter or exit the site, and each outfall will be inspected.
- e. The inspector will oversee the requirements of other construction-related Water Quality Permits (i.e. TDEC ARAP, US COE and TVA Section 26A permits) for construction activities around waters of the state.
- f. The SWPPP will be revised as necessary based on the results of the inspection. Revision(s) will be recorded within 7 days of the inspection. Revision(s) will be implemented within 14 days of the inspection.
- g. The inspector shall conduct pre-construction inspections to verify areas that are not to be disturbed have been marked in the SWPPP and in the field before land disturbance activities begin and initial measures have been installed. (10 "inspector")
- h. Inspections will be documented on the Construction Stormwater Inspection certification form provided in appendix c of the CGP and include the scope of the inspection, name(s), title and TN EPSC Certification Number of personnel making the inspection, the date(s) of the inspection, current approximate disturbed acreage at time of inspection, checklist (NOC, SWPPP, rain gauge, site contact information, etc.) And major observations relating to the implementation of the SWPPP.

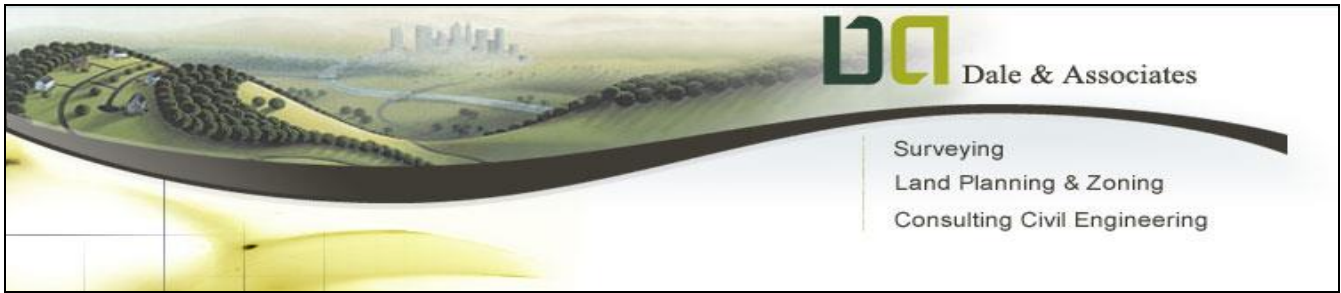

H. NON-STORM WATER DISCHARGES

1. Anticipated non-storm water discharges on the construction site may include the following:
 - a. *Waterline flushing from the newly installed waterlines.* Silt fences shall be used to collect sediment from water that is flushed from new waterlines.
 - b. *Discharge from fire fighting activities.* Any materials from fire fighting activities that may pollute the storm water shall be disposed of in a proper manner.
 - c. *Water Discharge from dust control.* Silt fences shall be used to collect sediment from discharge waters associated with dust control.

I. APPROVED STATE OR LOCAL PLANS

1. To the best knowledge of all parties involved with implementation of this Storm Water Pollution Prevention Plan, all measures and consideration specified in this plan meet the requirements of the Tennessee Department of Environment & Conservation NPDES permit TNR10-0000 and Davidson County.

This Plan was prepared in accordance with the Tennessee Dept. of Environment & Conservation NPDES Permit No. TNR10-0000 and the EPA Storm Water Management for Construction Activities.

J. SIGNATURE REQUIREMENTS

1. All reports and certifications shall be signed in accordance with part IV.B of the NPDES Permit TNR10-0000.

K. Tennessee Dept. of Env. & Conservation NPDES STORM WATER PERMIT TNR10-0000

1. The Tennessee Dept. of Environment & Conservation NPDES Storm Water Permit TNR10-0000, Appendix F, is considered part of this Storm Water Pollution Prevention Plan and shall be used as a reference and a guide to insure that all requirements, conditions, limitations and responsibilities are met.

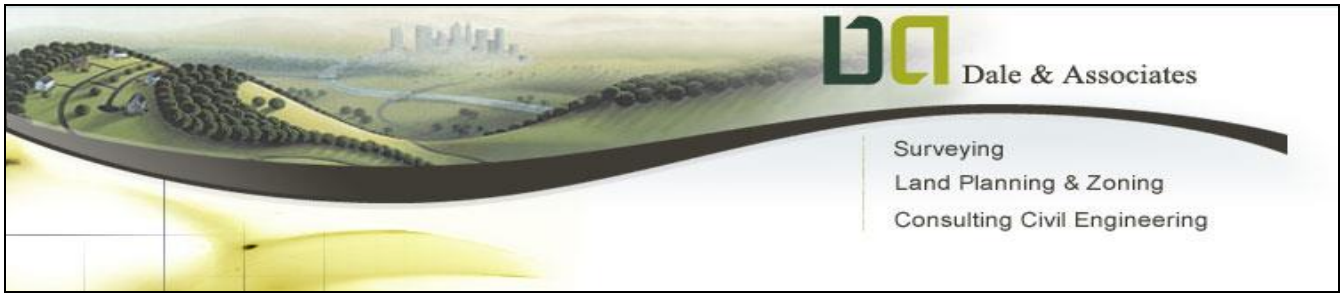

L. CONTRACTOR ASSIGNMENT

1. This plan will be modified to include the assignment of contractors and subcontractors to specific measures that are outlined herein.
2. All contractors and subcontractors will be required to sign a copy of the following certification statement before conducting any professional service at the site identified in this plan:

“I certify under penalty of law that I understand the terms and conditions of the general National Pollution Discharge Elimination System (NPDES) permit that authorizes the storm water discharges associated with industrial activity from the construction site as part of this certification.”

The preceding contractor / subcontractor certification must include the name and title of the person providing the signature; the name; address and telephone numbers of the contracting firm; the address; (or other identifying description) of the site; and the date the certification is made. Any signature affixed to this plan, or related documents, must be accompanied by the proper certification. The preceding contractor / subcontractor certification is part of permit number TNR10-0000, and is included as a part of this Storm Water Pollution Prevention Plan to serve as record only.

M. SIGNATORY REQUIREMENTS

The Signatory Requirements for all documents related to the permit number TNR10-0000 are as follows:

All Notices of Intent, Storm Water Pollution Prevention Plans, certifications or information either submitted to the Tennessee Dept. of Environment & Conservation or the operator of a large or medium municipal separate storm sewer system, or that this permit requires to be maintained by the permittee, shall be signed in accordance with the following:

Identity of signatories of operation permits applications. The person who signs the application for an operation permit shall be:

1. *Corporations.* In the case of a corporation, a responsible corporate officer, which is one of the following:
 - a. A president, secretary, treasurer, or vice-president of the corporation in charge of a principal business function, or any other person who performs similar policy or decision-making functions for the corporation; or

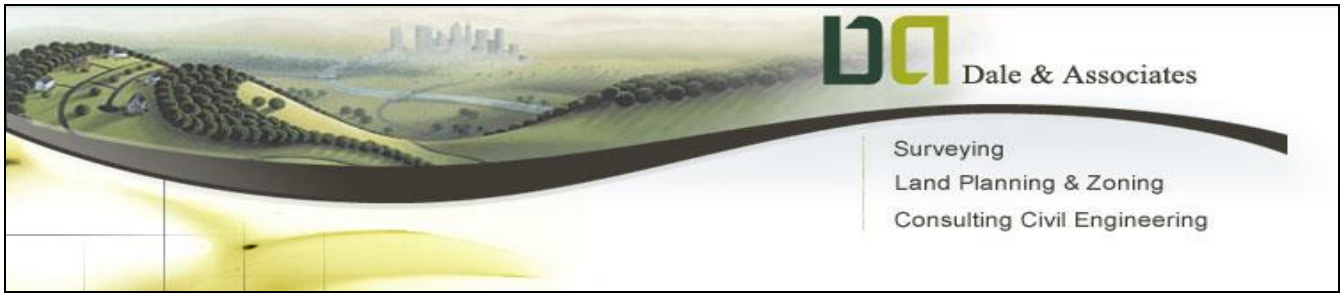

- b. The manager or one or more manufacturing, production, or operating facilities employing more than 250 persons or having gross annual sales or expenditures exceeding \$25 million (in second quarter 1980 dollars), if authority to sign documents has been assigned or delegated to the management in accordance with corporate procedures.
2. *Partnerships.* In the case of a sole partnership, a general partner.
3. *Sole proprietorships.* In the case of a sole proprietorship, the proprietor.
4. *Public Facilities.* In the case of a municipal, state, or other public facility, by either the principal executive officer, or the ranking elected official. A principal executive officer of a Federal Agency includes:
 - a. The chief executive officer of the agency; or
 - b. A senior executive officer having responsibility for the overall operations of a principal geographic unit of the agency.
5. *Storm water discharge associated with industrial activity from construction activity.* In the case of a storm water discharge associated with industrial activity from construction, either the owner of the site or general contractor.

The person who signs the NPDES reports shall be the same, except that in the case of a corporation, or a public body, monitoring reports required under the terms of the permit may be submitted by the person who is responsible for the overall operation of the facility from which the discharge originated. The preceding signatory requirements are a part of permit number TNR10-000, and are included as part of this Storm Water Pollution Prevention Plan to serve as record only.

N. **AUTHORIZATION**

All reports required by the permit and other information requested by the Director of the Tennessee Dept. of Environment & Conservation shall be signed by a person described above or by a duly authorized representative of that person. A person is a duly authorized representative only if:

1. The authorization is made in writing by a person described above and submitted to the Director;

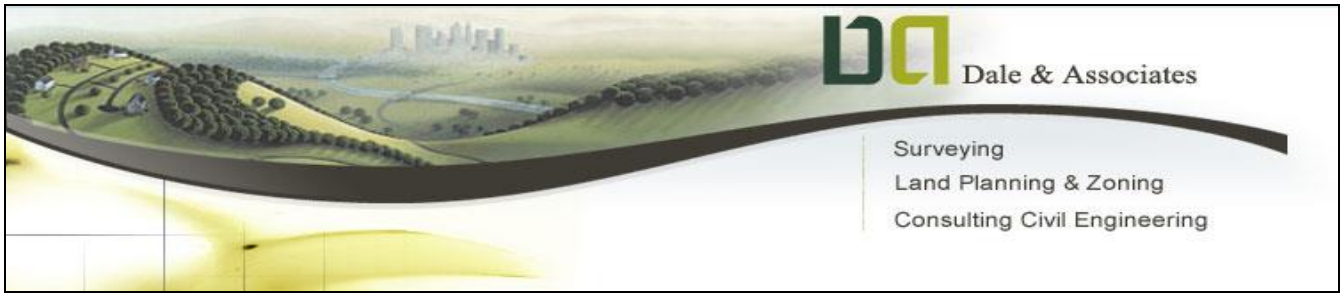

2. The authorization specifies either an individual or a person having responsibility for the overall operation on the regulated facility or activity, such as the position of plant manager, operator of a well or well field, superintendent, or position or equivalent responsibility, or position or equivalent responsibility for environmental matters for the company. (A duly authorized representative may thus be either a named individual or any individual occupying a named position); and
3. Changes to Authorization. If an authorization under this part is no longer accurate because a different individual or position has responsibility for the overall operation of the facility, a new authorization satisfying the above requirement must be submitted to the Director prior to or together with any reports, information, or applications to be signed by an authorized representative.

The preceding authorization requirements are a part of permit number TNR10-0000, and are included as a part of this Storm Water Pollution Prevention Plan to serve as a record only.

O. SIGNATURE CERTIFICATION

1. *Certification.* Any person signing documents shall make the following certification:

“I certify under penalty of law that this document and all attachments were prepared under my direction or supervision in accordance with a system designed to assure that qualified personnel properly gathered and evaluated the information submitted. Based on my inquiry of the person or persons who manage the systems, or those persons directly responsible for gathering the information, the information submitted is, to the best of my knowledge and belief, true, accurate, and complete. I am aware that there are significant penalties for submitting false information, including the possibility of fine and imprisonment for violations.”

The preceding signature certification is a part of permit number TNR10-0000, and is included as part of this Storm Water Pollution Prevention Plan to serve as record only. Any signature affixed to this plan or related documents must be accompanied by the proper certification.

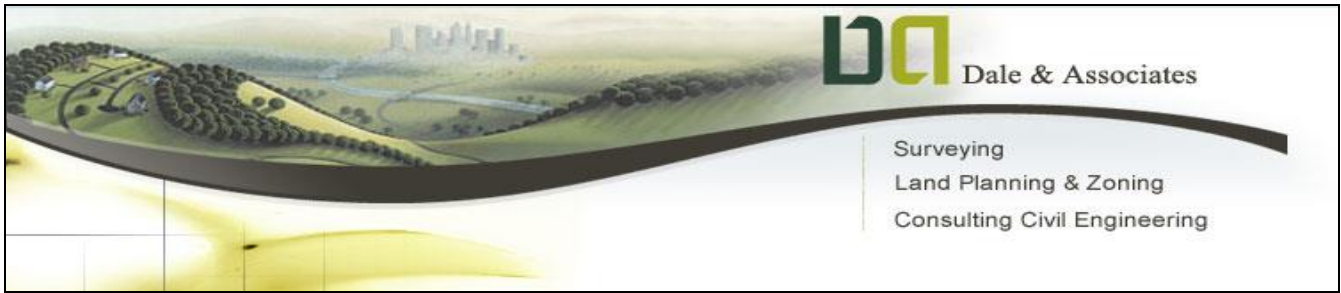

P. NOTICE OF TERMINATION

1. After final stabilization at the construction site, the contractor shall submit a Notice of Termination to the Department. This notice shall include the name of the owner that was issued the permit, and the general permit number. This notice shall also be accompanied by the following certification:

“I certify under penalty of law that disturbed soils at the identified facility have been finally stabilized and temporary erosion and sediment control measures have been removed or will be removed at an appropriate time, or that all storm water discharges associated with construction activities from the identified site that are authorized by a NPDES general permit have otherwise been eliminated. I understand that by submitting this Notice of Termination, that I am no longer authorized to discharge storm water associated with industrial activity by the general permit, and that discharging pollutants from storm water associated with industrial activity to waters of the State is unlawful under the Clean Water Act where the discharge is not authorized by a NPDES permit.”

The preceding Notice of Termination certification is a part of permit number TNR10-0000 and is included as a part of this Storm Water Pollution Prevention Plan to serve as record only. Any signature affixed to this plan or related documents must be accompanied by the proper certification.

Erosion Control and Grading Notes

- Expose as small an area of soil as possible on the site for no more than 15 days. Keep dust within tolerable limits by sprinkling or other acceptable means.
- All cut/fill areas to have a minimum of 6" of topsoil cover. Areas dressed with topsoil shall receive 12 lbs. per 1000 sq. ft. of 10-10-10 fertilizer (unless otherwise specified in written specifications), 5 lbs. or more of Kentucky 31 fescue seed per 1000 sq. ft., and a straw mulch cover of 70%-80% coverage (approximately 125 lbs. per 1000 sq. ft.), unless otherwise noted within written specifications.
- Erosion control barrier is called out on plans and is to comply with the Metropolitan stormwater management manual.
- Disturbed areas are to be graded to drain as indicated in the plan to sediment barriers during and upon the completion of construction.
- The contractor shall be responsible for the verification and the location of any existing utilities. It shall be the responsibility of the contractor to avoid damage to all existing utilities during construction. If damage does occur to any such installation, full repair will be accomplished as per the current specification governing such work.
- Any access routes to the site shall be based with crushed stone, ASTM #1 stone, 100' long and at least 6" thick.
- The placing and spreading of any fill material is to be started at the lowest point and brought up in horizontal layers of 8" thickness (or as directed by the soils investigative report). Said fill material is to be free of sod, roots, frozen soils, or any other decomposable material. Said fill is to be compacted to a minimum of 95% standard proctor, or as otherwise specified by the soils report or written specifications.
- The contractor shall notify the Metro Davidson County department of Public Works construction compliance division, three days prior to beginning the work.
- The contractor shall locate and stake the layout of the site in the field for inspection by the engineer. The contractor shall check the grades and final dimensions on the ground, and report any discrepancies to the engineer immediately for a decision.
- Surplus excavation of topsoil shall be placed on the site as approved by the owner for the purpose of future landscape use.
- The contractor shall furnish and install all necessary temporary works for the protection of the public and employees, including warning signs and lights.
- The contractor shall be responsible for any damage done to the premises or adjacent premises or injuries to the public during the construction caused by himself, his sub-contractors, or the carelessness of any of his employees.
- All work is to be completed with compliance to the rules and regulations set forth by Metro Water Services. The contractor shall give all necessary notice, obtain all permits, and pay fees required for the completion of his portion of the work. He shall also comply with all city, county and state laws and ordinance or regulations relating to portions of work which he is to perform.
- All erosion control measures shall remain in place until site is stabilized & construction is complete.
- Contractor to provide an area for concrete wash down and equipment fueling in accordance with metro CP-10 and CP-13, respectively. Contractor to coordinate exact location with NPDES department during the pre-construction meeting. Grading permittee to include bmp's designed to control site wastes such as discarded building materials, chemicals, litter and sanitary wastes that may cause adverse impacts to water quality. The location of and/or notes referring to said bmp's shall be shown on the EPSC plan.
- The buffer along waterways will be an area where the surface is left in a natural state, and is not disturbed by construction activity. This is in accordance with the Stormwater Management Manual Volume 1 - Regulations.

Public Works Notes

- All work within the public right of way requires an excavation permit from the department of public works.
- Proof-rolling of all street subgrades is required in the presence of the public works inspector. Inspection of the binder course is required prior to final paving in the presence of the public works inspector. These requests are to be made 24 hours in advance.
- Stop signs are to be 30 inch by 30 inch.
- Street signs to have six inch white letters on a nine inch green aluminum blade, high intensity reflective.
- All pavement marking are to be thermoplastic.

Landscape Notes

- The landscape contractor shall coordinate all construction with the appropriate utility company and shall be responsible for and damage to utilities. the landscape contractor shall verify the exact location of all utilities and take precautions to prevent damage to the utilities.
- All planting and mulch beds shall be sprayed with round-up (contractor's option) prior to the installation of mulch.
- Plant materials and stumps indicated for removal shall be removed and disposed off-site by the contractor. Backfill holes with topsoil free of roots and rocks.
- The landscape contractor shall be responsible for the fine grading of all planting areas.
- All planting areas shall be fertilized with 12#/1000 s.f. of 10-10-10 fertilizer.
- All planting beds shall have a minimum of 3" depth of shredded hardwood bark mulch.
- The landscape contractor shall verify all material quantities. In the event of a discrepancy, the quantities shown on the plan will take precedence.
- The landscape contractor shall provide the owner with written instructions on the proper care of all specified plant materials prior to final payment.
- Existing trees to remain shall be protected from construction damage. Selectively prune dead wood.
- All disturbed areas shall be planted with turf as indicated on the materials schedule.
- All deciduous trees, existing and proposed shall be pruned to provide 4" minimum clear trunk unless otherwise noted.
- The landscape contractor shall provide a one year warranty on all plant materials and replace any dead or dying material within that time period.
- No plant materials should be substituted without authorization by Dale & Associates. Plant sizes shown are minimums required by the local municipality and materials shown have been selected specifically for this project.
- All wire baskets shall be completely removed and disposed of, burlap should be removed or punctured in at least 5 places. Remove all twine from burlapped materials.
- Guying is not allowed unless required by municipality or site conditions. The landscape contractor shall remove wires after a one year period.
- No canopy tree shall be located within 15' of an overhead utility. No tree shall be located within a public utility easement. Locating plant materials within a drainage easement is acceptable, but only if installed as not to disturb existing drainage flow. In such instances, the materials shall be located no closer than 5' from the centerline of drainage.
- Lighting plan to be coordinated with proposed planting plan. no light poles to be located in tree islands. See lighting plan for proposed light locations.

MWS Standard Private Utility Plan Notes

- All water and sewer construction shall be in accordance with specifications and standard details of the Metro Water Services.
- All connections to existing manholes shall be by coring and resilient connector method.
- Vertical Double Check Valve Assemblies, that are located in interior rooms, can only be used for fire services.
- All water meters shall be a minimum of 24" not to exceed a maximum of 28" below finished grade.
- Irrigation line shall be copper from the meter to the backflow preventer.
- The minimum fees outlined in the capacity letter must be paid before commercial construction plans can be reviewed.
- All sewer services shall be minimum 6 inches in diameter, from connection at the main until the fires clean out assembly.
- Backflow device to remain accessible at all times.
- Plan size shall be 24" x 36" and shall show contours around meter boxes.
- Any unused existing water meters must be cut and capped at the public main.
- All lead or galvanized water service lines encountered with the project shall be reinstated with copper of like size from the water main to the meter box.
- Domestic and irrigation water meters and associated appurtenances shall be placed in or under a paved or improved surface other than the portion of the service located within the right of way.
- Sanitary sewer taps shall be placed at the lowest adjacent sewer main elevation for each premises and shall not be located in or under a paved or improved surface other than the portion within the right of way.

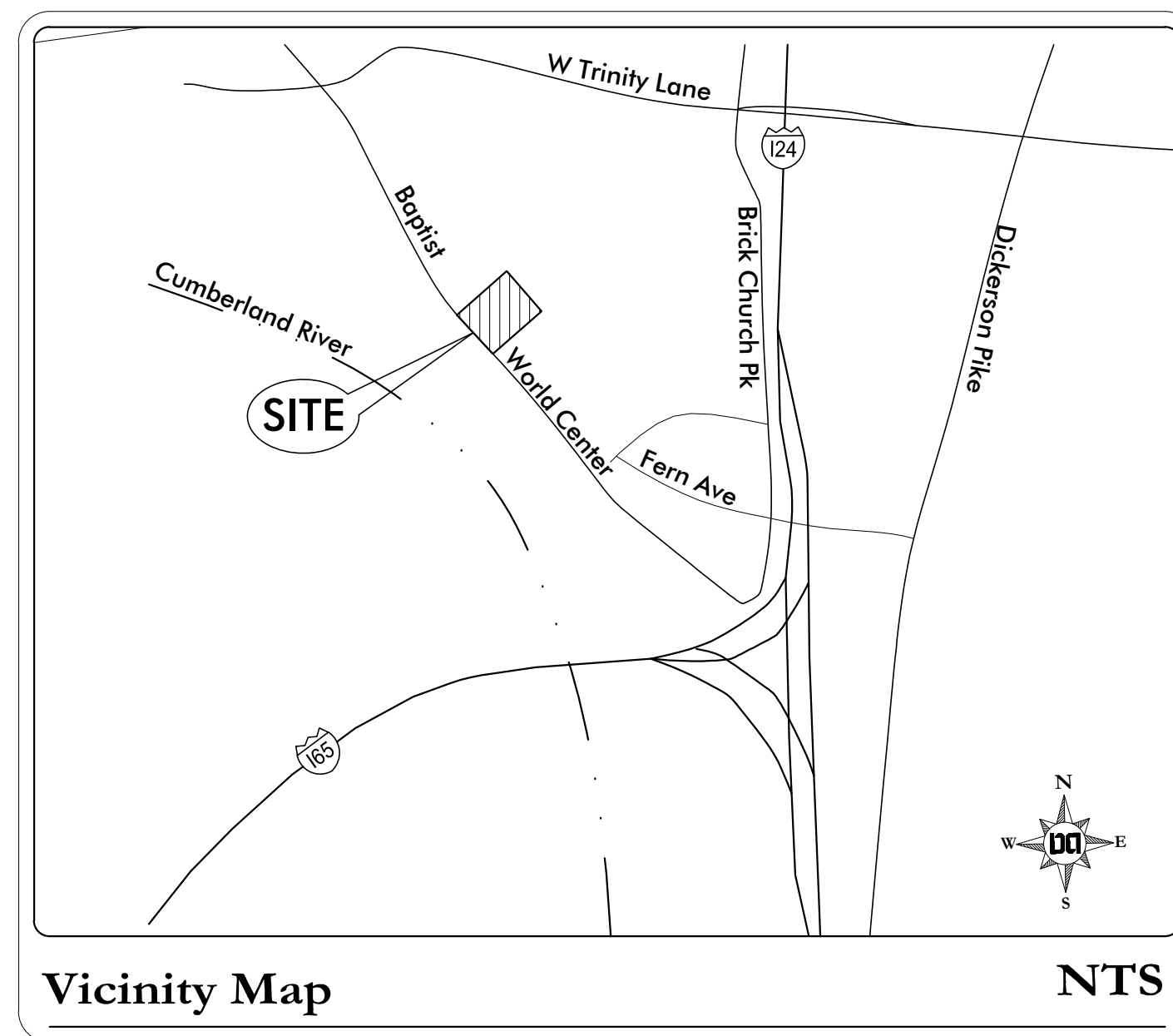

SHEET SCHEDULE

C0.0	Cover Sheet
C1.0	Overall Site Layout Plan
C2.0	Site Demo & Initial Erosion Control Plan
C3.0	Intermediate Erosion Control Plan
C4.0	Site Grading & Drainage Plan
C5.0	Site Utility Plan
L1.0	Landscape Plan

Site Plans

1311-1319 Baptist World Center

Multi-Family Development

Parcels 99, 100 & 103 on Tax Map 71-14
Parcels 1E00100CO, 1E00200CO, 1E00200CO, 1E90000CO,
1F00100CO, 1F00200CO & 1F90000CO on Tax Map 71-14
Nashville, Davidson County, Tennessee

USE - CHAPTER 17.08 & 17.16	
SPECIFIC PLAN DEVELOPMENT SUMMARY	
PROPOSED USE	Multifamily (15 Units)
PROPERTY ZONING	MUN-A & MUN-A NS OVERLAY(s) N/A SURROUNDING ZONING R55 & IWD
USE CHARTS:	PERMITTED
SITE CRITERIA	
SUBDIVISION PLAT	Not Applicable
MINIMUM LOT SIZE	Not Applicable (as shown herein)
Floor Area Ratio	0.60 MAX / 0.59 Proposed
ISR - Adjustments / Slopes over 15%	0.80 MAX / 0.34 Proposed
STREET SETBACKS:	Build to 0-15'
SIDE YARD	5' From Property Line
REAR YARD	20' From Property Line
HEIGHT STANDARDS	3 Stories In 45 Feet / 4 Stories in 60 Feet at Stepback
PARKING AND ACCESS - CHAPTER 17.20	
RAMP LOCATION AND NUMBER	1 Access from Baptist World Center
DISTANCE TO NEAREST EXISTING RAMP (MINIMUM 30')	110' Northwest along Baptist World Center
DISTANCE TO INTERSECTION	775' Northwest to Lock Road
	50' MINOR STREET 100' COLLECTOR 185' ARTERIAL STREET 250' CONTROLLED ACCESS RAMP
REQUIRED PARKING BASED ON USES	37 Stalls (2.5 Stalls per Unit)
PROPOSED PARKING	37 Stalls (30 Garage & 7 Offstreet)
SPACE SIZES, AISLE WIDTHS, ANGLE DATA	(30) 9' x 20' Garage & (7) 8.5' x 18' Offstreet (90°)
REQUIRED LOADING BASED ON USES	N/A
SURFACING OVER 5 SPACES 1,750 SQ. FT.	Provided
QUEUING LANES	Provided
OVER 10 SPACES 20' QUEUING AT EXIT	Provided
NUMBER OF COMPACT SPACES / %	None
NUMBER OF ACCESSIBLE SPACES	N/A
SIDEWALKS REQUIRED	Public Sidewalks Proposed along Baptist World Center
LANDSCAPING STANDARDS - CHAPTER 17.24	
REQUIRED BUFFERYARDS	"B" Buffers - South, East & West / "C" Buffer - North
BUFFERYARD ADJUSTMENT	Modified to reduce by 50% per 17.24.240 (E)
PERIMETER LANDSCAPING	Provided
STANDARD FOR 4 OR MORE LANES	N/A
SIDE LINES ADJACENT TO PARKING AREAS 5' MINIMUM WITH TREES-2.5' WITH TREE ISLANDS	Provided
INTERIOR LANDSCAPING MINIMUM 8% AREA	Provided
OPAQUE FENCE ADJACENT TO RESIDENTIAL PARKING AREA	Provided
SCREENING AROUND DUMPSTERS (NO CHAIN LINK FENCE PERMITTED)	
TREE DENSITY	See Landscape Compliance Plan

Property Information
1311-1319 Baptist World Center
Nashville, Tennessee 37207
1.10 Total Acres
Council District 02: Kyonzte Toombs

Owner/Developer
CW Building Group, LLC
1831 12th Avenue South, #105
Nashville, Tennessee 37203
Contact: Matt White
Phone: 615.330.1460
Email: matt@cwbuildinggroup.com

Civil Engineer
Dale & Associates
516 Heather Place
Nashville, Tennessee 37204
Contact: Michael Garrigan, PE
Phone: 615.297.5166
Email: michael@daleandassociates.net

Surveyor
Campbell, McRae & Associates
Contact: John Hood
Phone: 615.298.2424
Email: cmas@att.net

Flood Note
This property is not located within a Flood Hazard Area as depicted on the current Flood Insurance Rate Map (FIRM) Number 47037C0234H dated April 5, 2017.

Adjacent Hydrant Test

Existing fire hydrants, tag bolt numbers 09927 & 16924 at the intersection of Charlotte Pike and Hillwood Drive were flow tested by Metro Water Services, below is a summary of the results:

Static Pressure	68 psi
Residual Pressure	50 psi
Flow	187 gpm
Flow @ 20 psi	167 gpm

Based on table H.5.1 of the current NFPA, the building will not require a fire suppression system.

FORTHCOMING



Permits

Dale & Associates

Civil Engineering
Land Planning & Zoning
Surveying

516 Heather Place
Nashville, TN 37204
(615) 297-5166

D&A Project #20096
1311-1319 Baptist World Center

C0.0

Drawing Date:
September 2021

Revisions

Property Information
1311-1319 Baptist World Center
Nashville, Tennessee 37207
1.10 Total Acres
Council District 02: Kynzone Toombs

Owner/Developer
CW Building Group, LLC
1831 12th Avenue South, #105
Nashville, Tennessee 37203
Contact: Matt White
Phone: 615.330.1460
Email: matt@cwbuildinggroup.com

Civil Engineer
Dale & Associates
516 Heather Place
Nashville, Tennessee 37204
Contact: Michael Garrigan, PE
Phone: 615.297.5166
Email: michael@daleandassociates.net

Surveyor
Campbell, McRae & Associates
Contact: John Hood
Phone: 615.298.2424
Email: cmas@att.net

Flood Note
This property is not located within a Flood Hazard Area as depicted on the current Flood Insurance Rate Map (FIRM) Number 47037C0234H dated April 5, 2017.

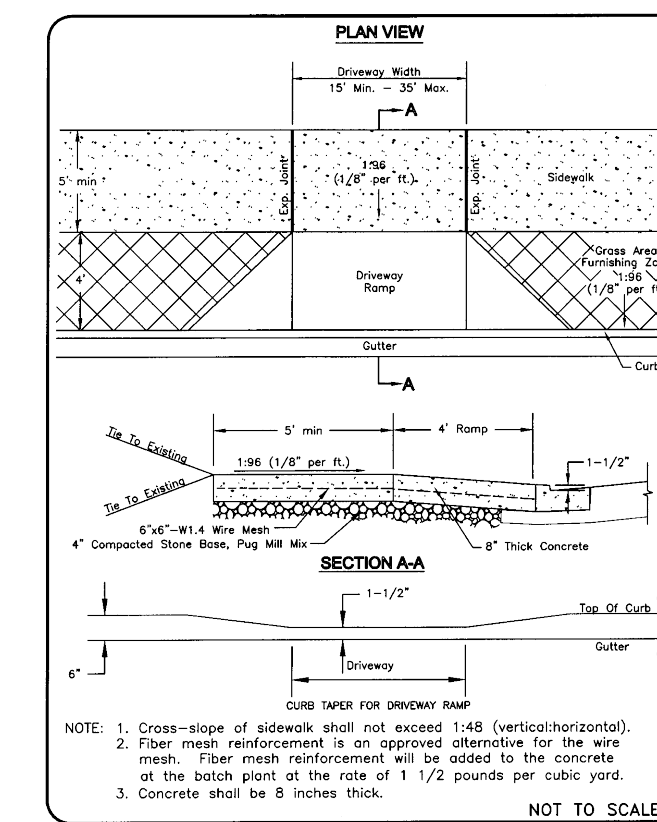

NEW CONSTRUCTION COMMERCIAL DRIVEWAY RAMP
DWG. NO. ST-324
DATE: 5/12/21

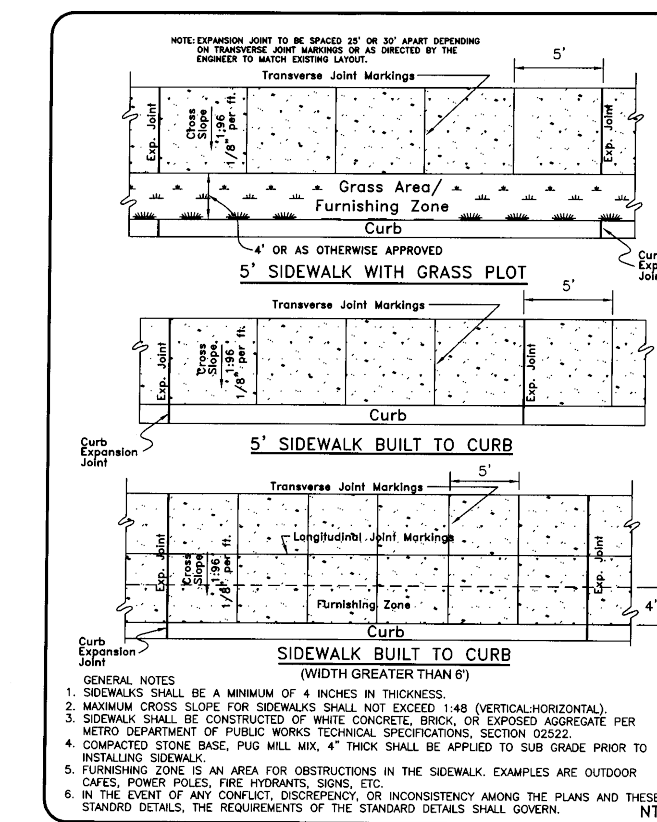

SIDEWALK BUILT TO CURB WITH GUTTER
DWG. NO. ST-210
DATE: 1/15/21

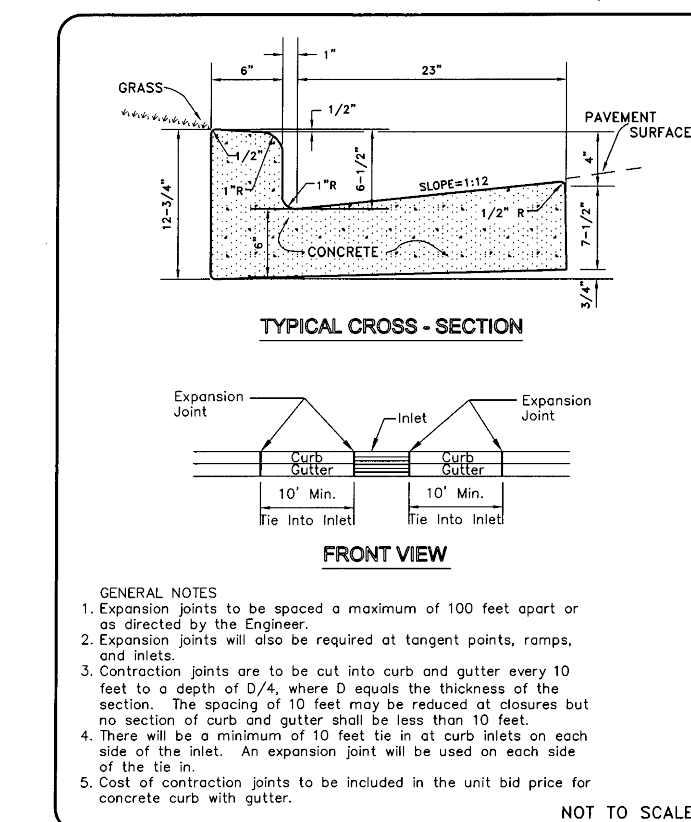

STANDARD CURB WITH GUTTER
DWG. NO. ST-200
DATE: 5/12/21

Note:
Solid waste to be provided by private hauler via individual roll-away cans.

1311-1319 Baptist World Center

Parcels 99, 100 & 103 on Tax Map 71-14
Parcels 1E001000CO, 1E002000CO, 1E002000CO, 1E900000CO,
1F001000CO, 1F002000CO & 1F900000CO on Tax Map 71-14
Nashville, Davidson County, Tennessee

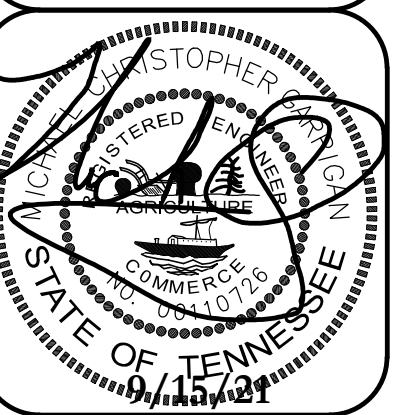

Overall Site Layout Plan

Dale & Associates
Civil Engineering
Land Planning & Zoning
Surveying
516 Heather Place
Nashville, TN 37204
(615) 297-5166
D&A Project #20096
1311-1319 Baptist World Center
C1.0

Landscape Buffer Yard Summary
This site requires a 10' wide "B-3" Landscape Buffer along the north, south and west property lines (MUN-A zoning adjacent to IWD zoning) as well as a 20' wide "C-3" Landscape Buffer along the east (or rear) property line (MUN-A zoning adjacent to RS5 zoning). Applying these quantities results in 10,387 sq ft of Landscape Bufferyard. After Right of Way dedication, this site measures 46,416 sq ft. Therefore, the Landscape Bufferyards total up to 22% of the gross land area.

In accordance with Section 17.24.240(E) of the Zoning Code the bufferyard widths and plant quantities may be reduced by up to fifty percent and is proposed to be such as shown herein.

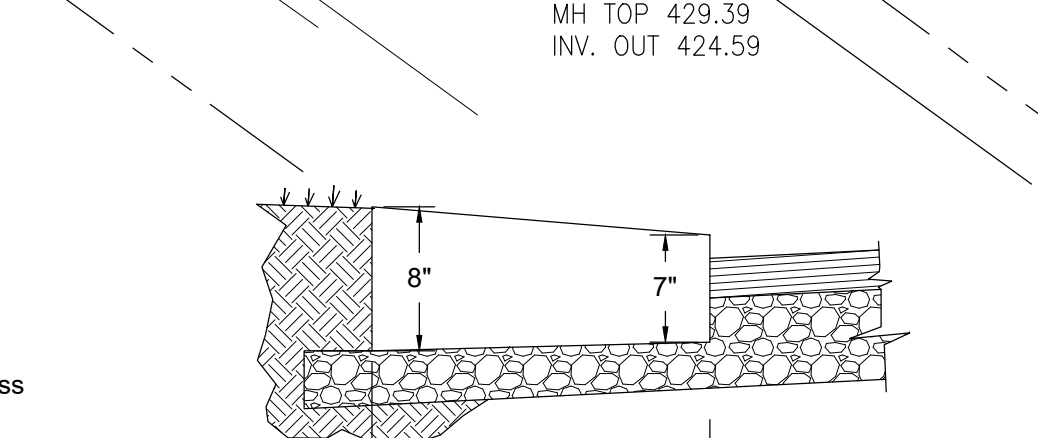
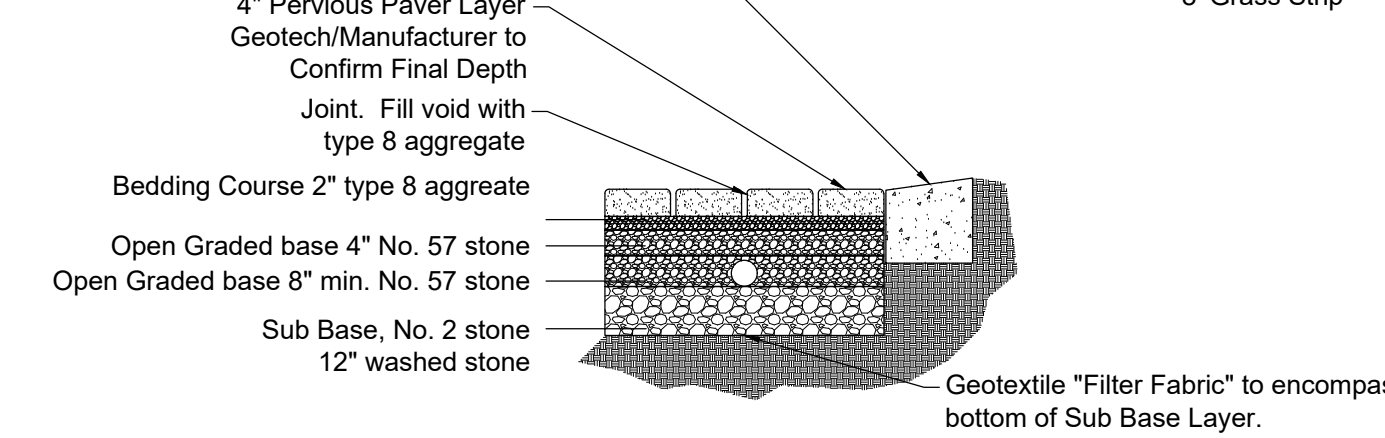
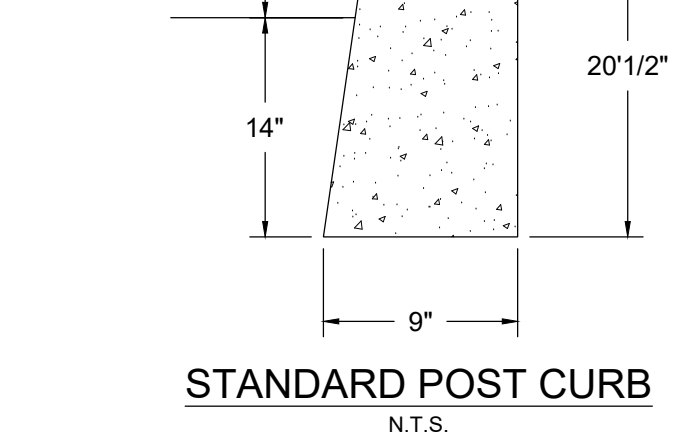
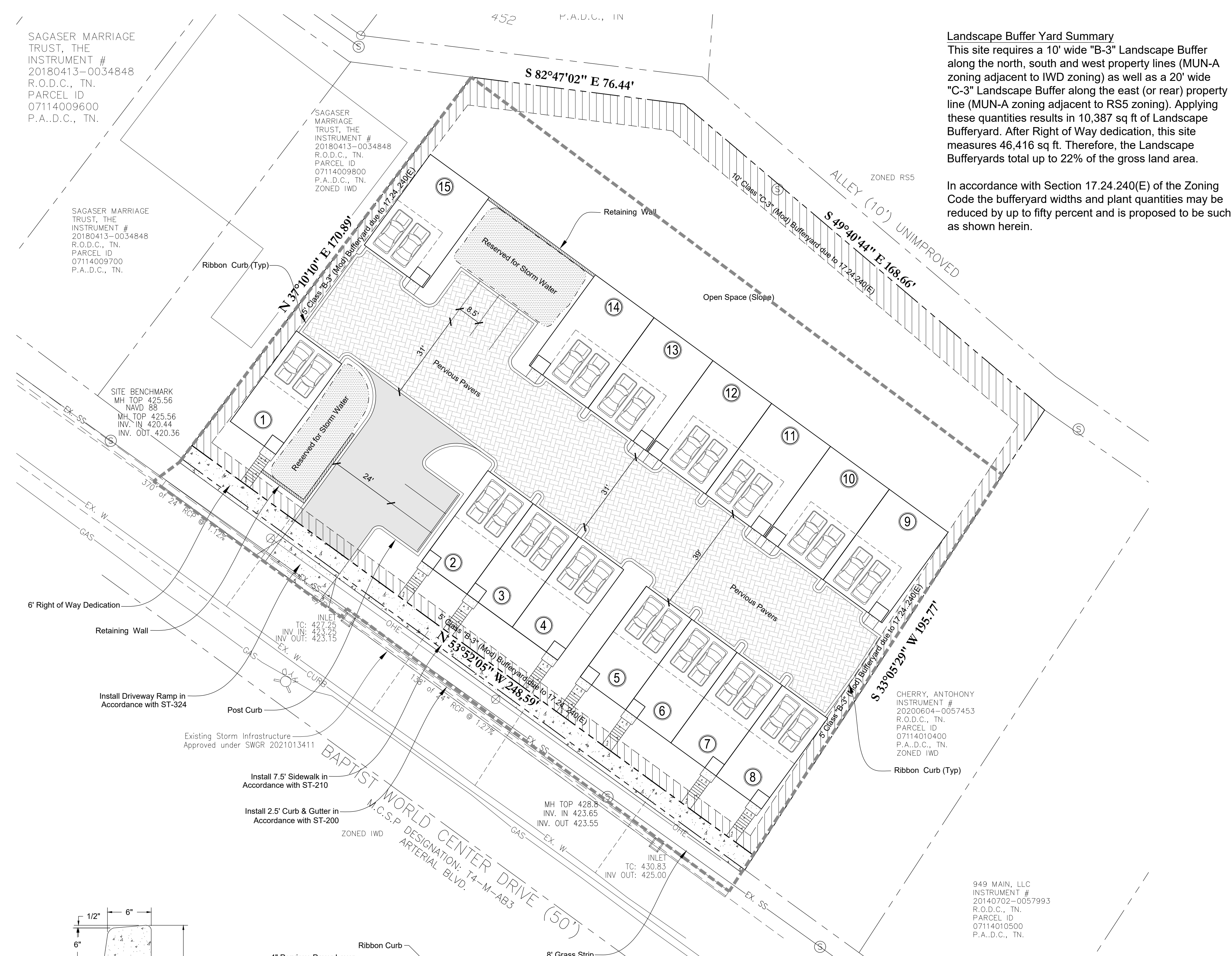

- General Notes:
- Expansion joints to be spaced a max. of 100' apart or as directed by engineer.
 - Expansion joints will also be required at tangent points, ramps, and inlets.
 - Contraction joints are to be cut into curb and gutter every 10' to a depth of D/4, where D equals the thickness of the section. The spacing of 10' may be reduced at closures but no section of curb shall be less than 10'.
 - Cost of joints to be included in the unit bid price for concrete curb.

- Notes:
- Contractor, engineer, owners representative shall notify Metro Water Services development review at least 24 hrs. prior to the installation of the pervious layer to observe the sub base material.
 - Vehicular traffic shall be prohibited on the pervious pavement until the site is stable to prevent mud from being deposited by vehicle.
 - All stone to be Clean Washed and free of Fines.

- General Notes:
- Expansion joints to be spaced a max. of 100' apart or as directed by engineer.
 - Expansion joints will also be required at tangent points, ramps, and inlets.
 - Contraction joints are to be cut into curb and gutter every 10' to a depth of D/4, where d equals the thickness of the section. The spacing of 10' may be reduced at closures but no section of curb shall be less than 10'.

949 MAIN, LLC
INSTRUMENT # 20140702-0057993
R.O.D.C., TN.
PARCEL ID 07114010500
P.A.D.C., TN.
ZONED IWD



SCALE: 1" = 20'
SITE AREA (GROSS) = 47,867 Sq Ft (1.10 Acres)
SITE AREA (NET) = 46,416 Sq Ft (1.07 Acres)
DISTURBED AREA = 42,518 Sq Ft (0.98 Acres)

Permits

SAGASER MARRIAGE TRUST, THE INSTRUMENT # 20180413-0034848 R.O.D.C., TN. PARCEL ID 07114009600 P.A.D.C., TN.

SAGASER MARRIAGE TRUST, THE INSTRUMENT # 20180413-0034848 R.O.D.C., TN. PARCEL ID 07114009700 P.A.D.C., TN.

SAGASER MARRIAGE TRUST, THE INSTRUMENT # 20180413-0034848 R.O.D.C., TN. PARCEL ID 07114009800 P.A.D.C., TN. ZONED IWD

HEITMAN, DANA INSTRUMENT # 20160301-0019324 R.O.D.C., TN. PARCEL ID 07114009900 P.A.D.C., TN. ZONED MUN-A

KIMBROUGH, PAUL INSTRUMENT # 20140805-0070464 R.O.D.C., TN. PARCEL ID 07114010000 P.A.D.C., TN. ZONED MUN-A NS

O.I.C. 1315 BAPTIST WORLD CENTER DRIVE INSTRUMENT # 202011170135505 R.O.D.C., TN. PARCEL ID 071141F900000 P.A.D.C., TN.

O.I.C. THIRTEENTH BAPTIST WORLD CE INSTRUMENT # 202011170135502 R.O.D.C., TN. PARCEL ID 071141E900000 P.A.D.C., TN. MUN-A

1314 BWC PARTNERS, LLC INSTRUMENT # 20201211-0746077 R.O.D.C., TN. PARCEL ID 07114010300 P.A.D.C., TN. ZONED MUN-A

CHERRY, ANTHONY INSTRUMENT # 20200604-0057453 R.O.D.C., TN. PARCEL ID 07114010400 P.A.D.C., TN. ZONED IWD

949 MAIN, LLC INSTRUMENT # 20140702-0057993 R.O.D.C., TN. PARCEL ID 07114010500 P.A.D.C., TN.

TOTAL AREA 47866.91 S.F. OR 1.10 ACRES±

PORTION OF ALLEY #2004 ABANDONED, INCLUDING EASEMENTS BY ORDINANCE BL2021-625

ALLEY (10') UNIMPROVED

S 49°40'44" E 168.56'

S 82°47'02" E 76.44'

N 37°10'10" E 170.89'

N 53°52'05" W 248.55'

S 33°00'29" W 195.77'

Existing Storm Infrastructure Approved under SWGR 2021013411

BAPTIST WORLD CENTER DRIVE (50') M.C.S.P. DESIGNATION: 74-M-AB3 ARTERIAL BLVD. ZONED IWD

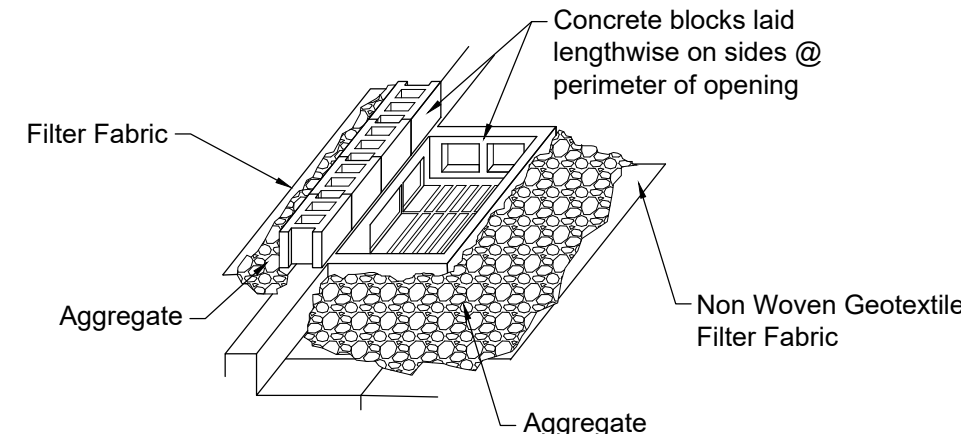

* Inlet protection to be provided for all inlets and remain in place until site is stabilized.

- Notes:
- Use clean 3/4" (19 mm) gravel or approx. equal.
 - Periodically change gravel with new, clean gravel. Old gravel may be used as backfill material if approved by Engineer.

STREET INLET SEDIMENT BARRIER N.T.S.

** Equivalent sediment control methods such as basin buddies or erosion eels are allowed.

STABILIZATION OF DISTURBED SOILS

- Soil Stabilization will be accomplished by the use of seeding in the appropriate areas, as specified. Temporary seeding will be required in those areas that consist of disturbed soils that have remained dormant for periods of more than 15 days.
- As a general rule, permanent seeding will be performed within 14 days after the final grade on an area has been established. If disturbed areas on-site are to remain dormant for periods greater than 15 days in duration, the contractor will apply permanent soil stabilization. An allowance in the time schedule will be made for snow cover during periods of construction downtime. Seeding will be performed by hydro-seeding, by hand, or by a mechanical broadcasting method.
- The areas to be seeded will be uniform and will conform to the finished grade and cross Section shown in the plans for this project or as otherwise designated. Owner's representative will perform minor shaping of uneven and rough areas outside the graded section as directed in order to provide for more effective erosion control and for ease of subsequent earth moving operations.
- The seed bed (including cut slopes) will be loosened to a minimum depth of 3 inches before agricultural lime, fertilizer or seed is applied. The areas to be seeded will be cleared of stones larger than 2.5 inches in dimension, roots, and other debris.

I, NLO, AS THE "CERTIFIED" EROSION CONTROL SPECIALIST FOR THIS SITE, HAVE REVIEWED AND APPROVED THE EROSION PREVENTION AND SEDIMENT CONTROL BMP'S OF THIS PLAN ON September 15, 2021 DATE

AS THE DESIGN ENGINEER RESPONSIBLE FOR THE DEVELOPMENT OF THESE PLANS, I DO HEREBY CERTIFY THAT THIS DEVELOPMENT WILL DISTURB LESS THAN (1) ONE ACRE.

NLO September 15, 2021 ENGINEER DATE

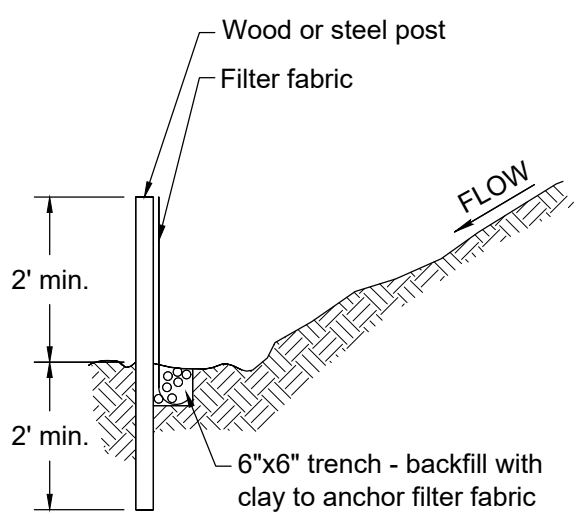

SILT FENCE DETAIL
REFER TO METRO DETAIL TCP-13 N.T.S.

- Silt Fence Notes:
- Non Woven Geotextile Filter fabric fence to be placed prior to start of rough grading.
 - Steel posts shall be approved by owner prior to use.
 - Wood posts shall be 2"x2" min., oak or similar hardwood.
 - Posts shall be spaced at 6' intervals.
 - Filter fabric shall be securely bound to posts with either staples or wire ties.
 - Filter fabric shall be polypropylene fabric by Corps of Engineers guide spec. CW 02215. With equivalent opening size (eos) of no. 100 sieve min., no. 40 sieve max., as determined.
 - J-Hooks to be used when silt fence is not installed along a contour.

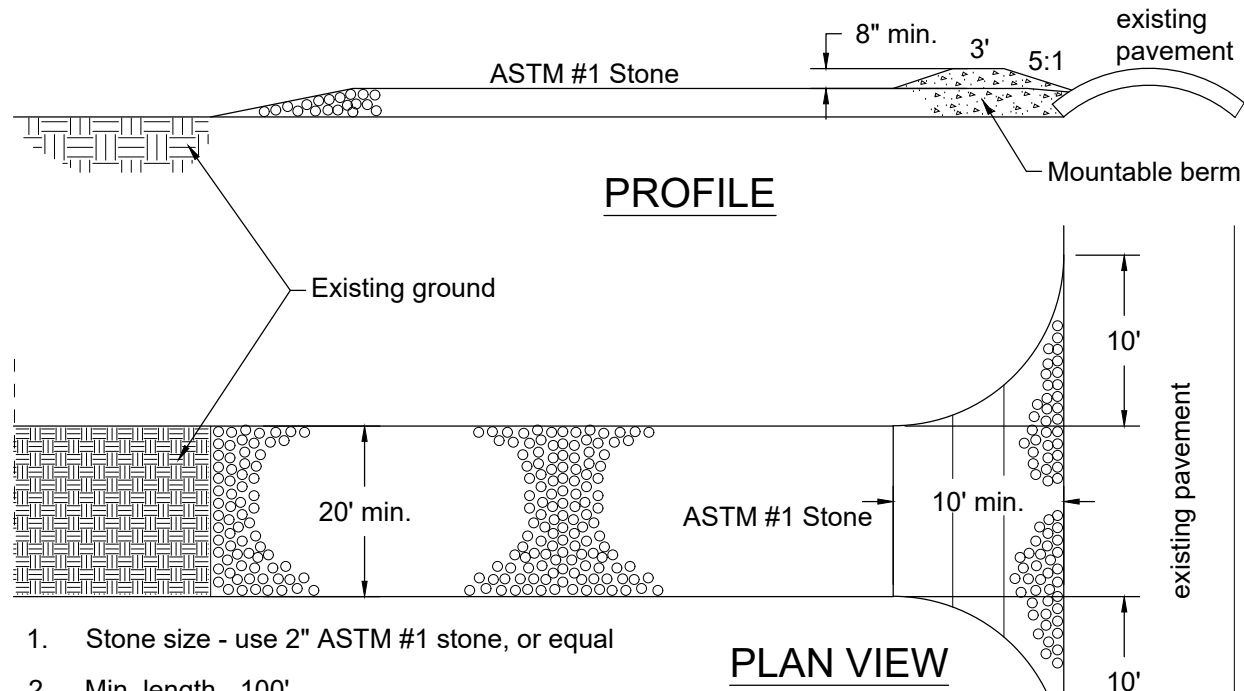

- Stone size - use 2" ASTM #1 stone, or equal
- Min. length - 100'
- Min. thickness - 8"
- Min. width - 20'
- Non Woven Geotextile Filter Fabric will be placed over the entire area prior to placing of stone.
- Surface water all surface water flowing or diverted toward construction entrances shall be piped across the entrance.
- Maintenance - the entrance shall be maintained in a condition which will prevent tracking or flowing of sediment onto public rights-of-way. This may require periodic top dressing with additional stone as conditions demand, and repair and/or clean out of any measures used to trap sediment. All sediment spilled, dropped, washed or tracked onto public rights-of-way must be removed immediately.

TEMPORARY CONSTRUCTION EXIT
REFER TO METRO DETAIL TCP-03 N.T.S.

EPSC NOTES

- ALL PERIMETER EPSC MEASURES MUST BE IN PLACE PRIOR TO GRADING.
- ANY DISTURBED AREA LEFT EXPOSED FOR A PERIOD GREATER THAN 7 DAYS WITH SLOPES GREATER THAN OR EQUAL TO 3:1 SHALL BE STABILIZED WITH MULCH OR TEMPORARY SEEDING.
- ALL SLOPES 3:1 OR GREATER AND CHANNEL SIDE SLOPES TO RECEIVE EROSION CONTROL MATTING.

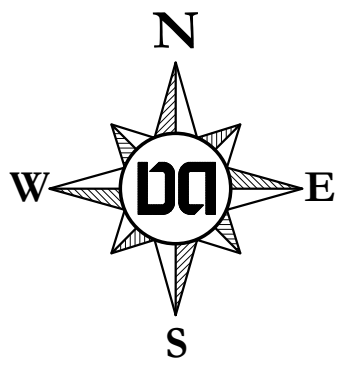

SCALE: 1" = 20'
SITE AREA (GROSS) = 47,867 Sq Ft (1.10 Acres)
SITE AREA (NET) = 46,416 Sq Ft (1.07 Acres)
DISTURBED AREA = 42,518 Sq Ft (0.98 Acres)

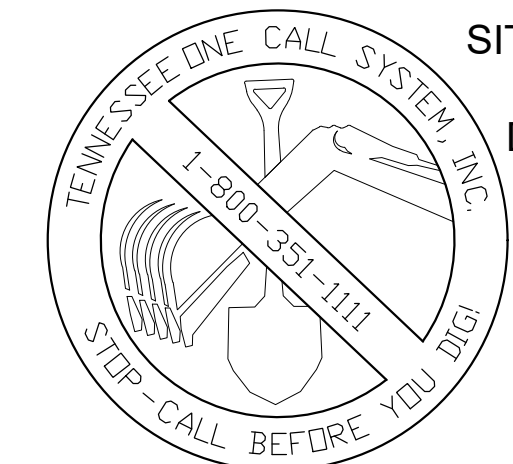

Permits

Property Information
1311-1319 Baptist World Center
Nashville, Tennessee 37207
1.10 Total Acres
Council District 02: Kynzone Toombs

Owner/Developer
CW Building Group, LLC
1831 12th Avenue South, #105
Nashville, Tennessee 37203
Contact: Matt White
Phone: 615.330.1460
Email: matt@cwbuildinggroup.com

Civil Engineer
Dale & Associates
516 Heather Place
Nashville, Tennessee 37204
Contact: Michael Garrigan, PE
Phone: 615.297.5166
Email: michael@daleandassociates.net

Surveyor
Campbell, McRae & Associates
Contact: John Hood
Phone: 615.298.2424
Email: cmas@att.net

Flood Note
This property is not located within a Flood Hazard Area as depicted on the current Flood Insurance Rate Map (FIRM) Number 47037C0234H dated April 5, 2017.

Drawing Date:
September 2021

Revisions

1311-1319 Baptist World Center

Parcels 99, 100 & 103 on Tax Map 71-14
Parcels 1E00100CO, 1E00200CO, 1E00200CO, 1E90000CO,
1F00100CO, 1F00200CO & 1F90000CO on Tax Map 71-14
Nashville, Davidson County, Tennessee

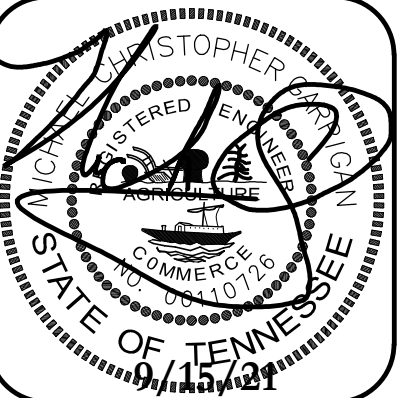

Site Demo & Initial Erosion Control Plan

Dale & Associates
Civil Engineering
Land Planning & Zoning
Surveying
516 Heather Place
Nashville, TN 37204
(615) 297-5166

D&A Project #20096
1311-1319 Baptist World Center
C2.0

SAGASER MARRIAGE TRUST, THE INSTRUMENT # 20180413-0034848 R.O.D.C., TN. PARCEL ID 07114009600 P.A.D.C., TN.

SAGASER MARRIAGE TRUST, THE INSTRUMENT # 20180413-0034848 R.O.D.C., TN. PARCEL ID 07114009700 P.A.D.C., TN.

Provide Erosion Eels around the Perimeter of Bioretention Area

Maintain Construction Entrance

SITE BENCHMARK MH TOP 425.56 NAVD 88 MH TOP 425.56 INV. IN 420.44 INV. OUT 420.36

Maintain Silt Fence

Provide Inlet Protection per Street Inlet Sediment Barrier Detail for any Existing Inlets

Existing Storm Infrastructure Approved under SWGR 2021013411

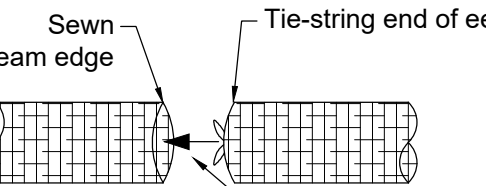

BUTT JOINT DETAIL E1-B1

To form butt joint, press tied end of eel against sewn edge of adjacent eel.

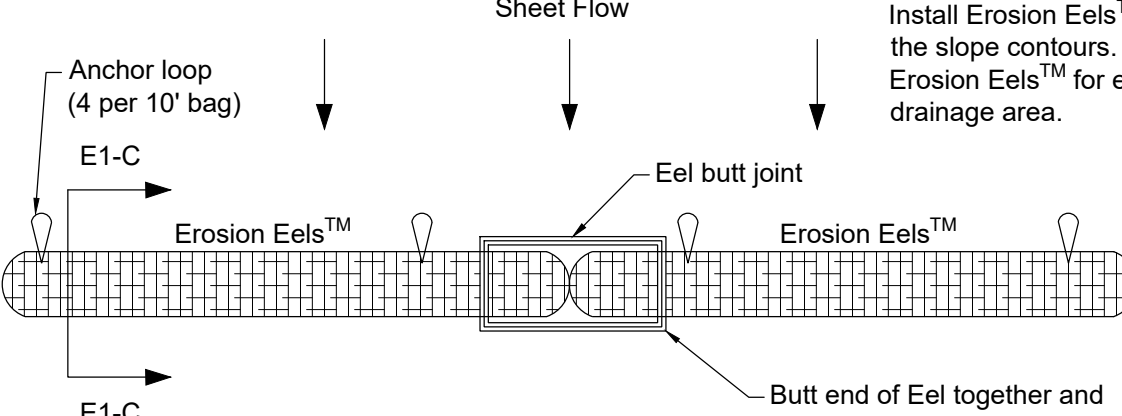

EROSION EEL DETAIL N.T.S.

Contact Eco Sediment for Eel Pricing & Shipping (615 278-6796 ecosediment@gmail.com)

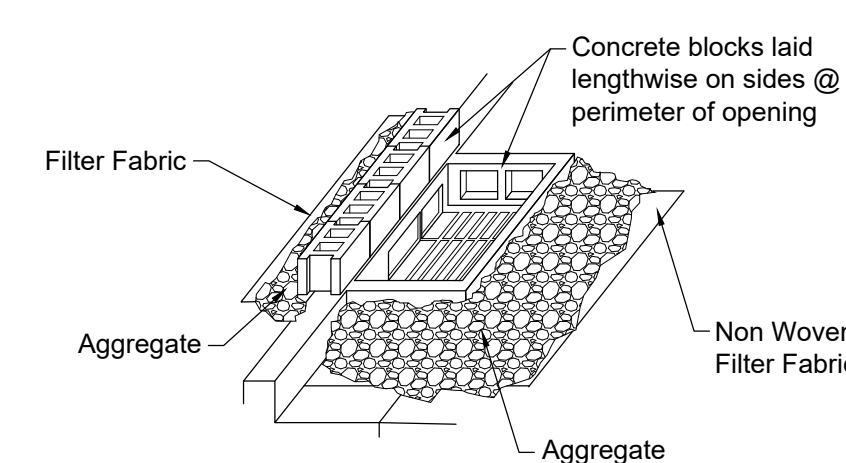

DETAIL E1-B: INTERCEPTING SHEET FLOW PERPENDICULAR TO FLOW PATH - PLAN VIEW

STREET INLET SEDIMENT BARRIER N.T.S.

Notes:

- Use clean 3/4" (19 mm) gravel or approx. eqval.
- Periodically change gravel with new, clean gravel. Old gravel may be used as backfill material if approved by Engineer.

** Equivalent sediment control methods such as basin buddies or erosion eels are allowed.

EPSC NOTES

- ALL PERIMETER EPSC MEASURES MUST BE IN PLACE PRIOR TO GRADING.
- ANY DISTURBED AREA LEFT EXPOSED FOR A PERIOD GREATER THAN 7 DAYS WITH SLOPES GREATER THAN OR EQUAL TO 3:1 SHALL BE STABILIZED WITH MULCH OR TEMPORARY SEEDING.
- ALL SLOPES 3:1 OR GREATER AND CHANNEL SIDE SLOPES TO RECEIVE EROSION CONTROL MATTING.

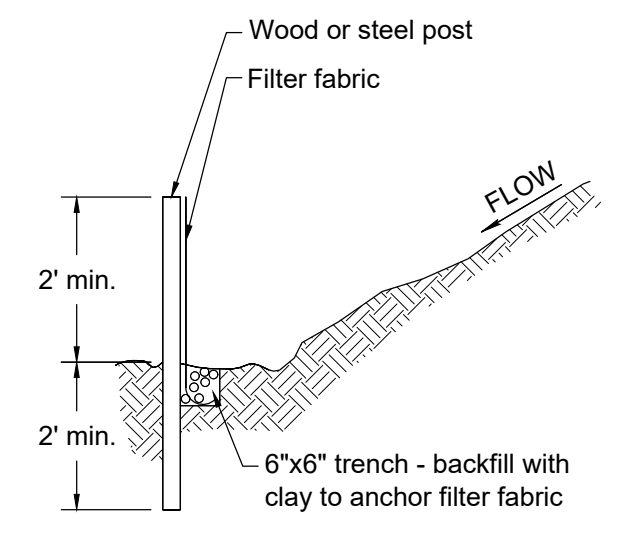

SILT FENCE DETAIL REFER TO METRO DETAIL TCP-13 N.T.S.

Silt Fence Notes:

- Non Woven Geotextile Filter fabric fence to be placed prior to start of rough grading.
- Steel posts shall be approved by owner prior to use.
- Wood posts shall be 2"x 2" min., oak or similar hardwood.
- Posts shall be spaced at 6' intervals.
- Filter fabric shall be securely bound to posts with either staples or wire ties.
- Filter fabric shall be polypropylene fabric by Corps of Engineers guide spec. CW 02215. With equivalent opening size (eos) of no. 100 sieve min., no. 40 sieve max., as determined.
- J-Hooks to be used when silt fence is not installed along a contour.

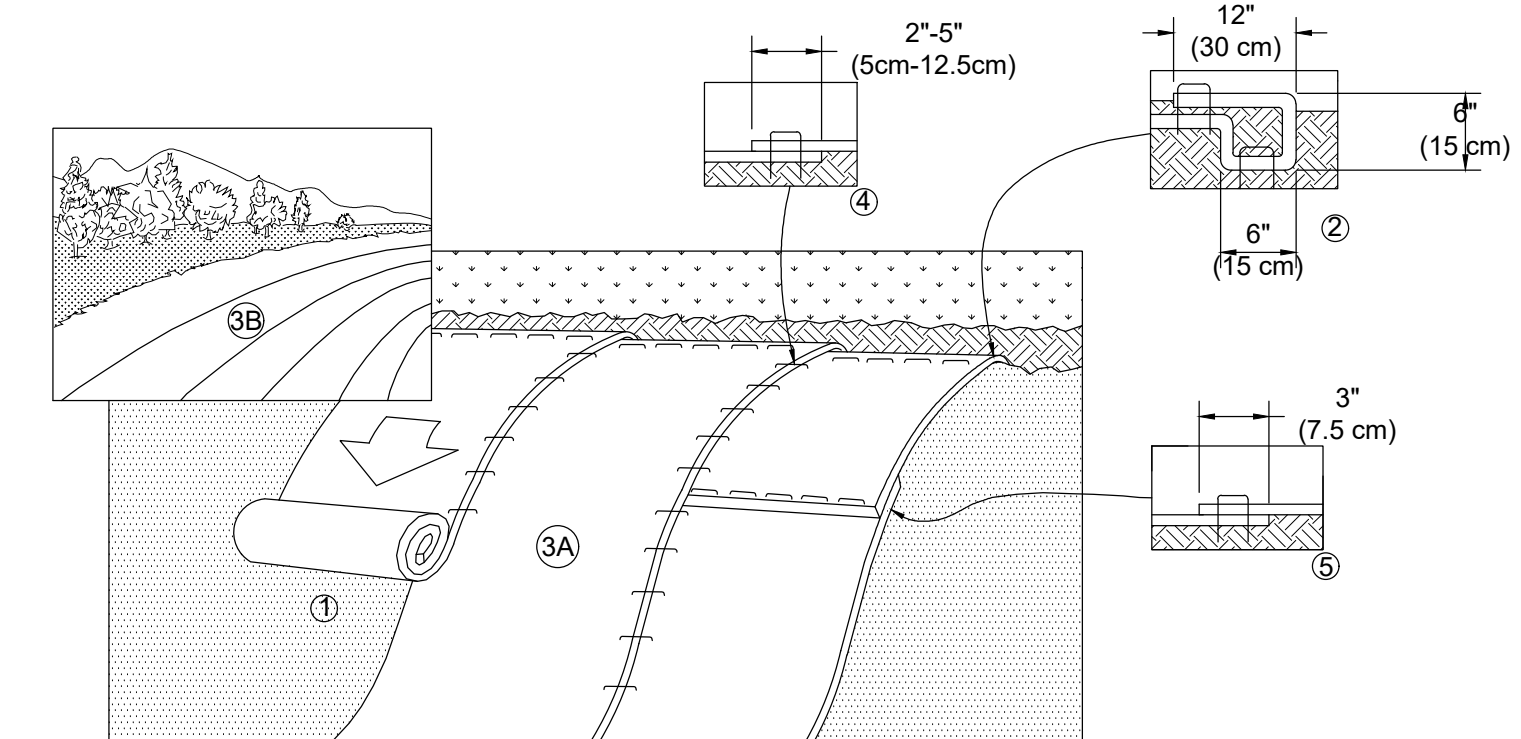

Notes:

- Prepare soil before installing blankets, including any necessary application of lime, fertilizer, and seed. Note: When using Cell-o-seed™ do not seed prepared area. Cell-o-seed™ must be installed with paper side down.
- Begin at the top of the slope by anchoring the blanket in a 6" (15cm) deep x 6" (15cm) wide trench with approximately 12" (30cm) of blanket extended beyond the up-slope portion of the trench. Anchor the blanket with a row of staples/stakes approximately 12" (30cm) apart in the bottom of the trench. Backfill and compact the trench after stapling. Apply seed to compacted soil and fold remaining 12" (30cm) portion of blanket back over seed and compacted soil. Secure blanket over compacted soil with a row of staples/stakes spaced approximately 12" (30cm) apart across the width of the blanket.
- Roll the blankets (a.) down or (b.) horizontally across the slope. Blankets will unroll with appropriate side against the soil surface. All blankets must be securely fastened to soil surface by placing staples/stakes in appropriate locations as shown in the staple pattern guide. When using optional dot system, staples/stakes should be placed through each of the colored dots corresponding to the appropriate staple pattern.
- The edges of parallel blankets must be stapled with approximately 2"-5" (5cm-12.5cm) overlap depending on blanket type. To ensure proper seam alignment, place the edge of the overlapping blanket (blanket being installed on top) even with the colored seam stitch on the previously installed blanket.
- Consecutive blankets spliced down the slope must be placed end over end (shingle style) with an approximate 3" (7.5cm) overlap. staple through overlapped area, approximately 12" (30cm) apart across entire blanket width.

*In loose soil conditions, the use of staple or stake lengths greater than 6" (15 cm) may be necessary to properly secure the blankets.

EROSION CONTROL MATTING DETAIL REFER TO METRO DETAIL TCP-19 N.T.S.

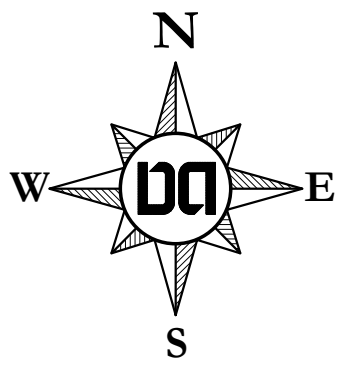

SCALE: 1" = 20'

SITE AREA (GROSS) = 47,867 Sq Ft (1.10 Acres)
SITE AREA (NET) = 46,416 Sq Ft (1.07 Acres)
DISTURBED AREA = 42,518 Sq Ft (0.98 Acres)

Permits

STABILIZATION OF DISTURBED SOILS

- Soil Stabilization will be accomplished by the use of seeding in the appropriate areas, as specified. Temporary seeding will be required in those areas that consist of disturbed soils that have remained dormant for periods of more than 15 days.
- As a general rule, permanent seeding will be performed within 14 days after the final grade on an area has been established. If disturbed areas on-site are to remain dormant for periods greater than 15 days in duration, the contractor will apply permanent soil stabilization. An allowance in the time schedule will be made for snow cover during periods of construction downtime. Seeding will be performed by hydro-seeding, by hand, or by a mechanical broadcasting method.
- The areas to be seeded will be uniform and will conform to the finished grade and cross section shown in the plans for this project or as otherwise designated. Owner's representative will perform minor shaping of uneven and rough areas outside the graded section as directed in order to provide for more effective erosion control and for ease of subsequent earth moving operations.
- The seed bed (including cut slopes) will be loosened to a minimum depth of 3 inches before agricultural lime, fertilizer or seed is applied. The areas to be seeded will be cleared of stones larger than 2.5 inches in dimension, roots, and other debris.

I, WLO, AS THE "CERTIFIED" EROSION CONTROL SPECIALIST FOR THIS SITE, HAVE REVIEWED AND APPROVED THE EROSION PREVENTION AND SEDIMENT CONTROL BMP'S OF THIS PLAN ON _____ September 15, 2021 DATE

AS THE DESIGN ENGINEER RESPONSIBLE FOR THE DEVELOPMENT OF THESE PLANS, I DO HEREBY CERTIFY THAT THIS DEVELOPMENT WILL DISTURB LESS THAN (1) ONE ACRE.

WLO September 15, 2021 DATE
ENGINEER

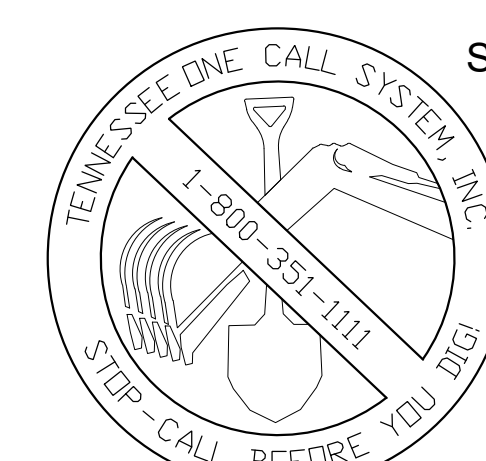

Drawing Date: September 2021

Revisions

Revisions

Property Information
1311-1319 Baptist World Center
Nashville, Tennessee 37207
1.10 Total Acres
Council District 02: Kynzone Toombs

Owner/Developer
CW Building Group, LLC
1831 12th Avenue South, #105
Nashville, Tennessee 37203
Contact: Matt White
Phone: 615.330.1460
Email: matt@cwbuildinggroup.com

Civil Engineer
Dale & Associates
516 Heather Place
Nashville, Tennessee 37204
Contact: Michael Garrigan, PE
Phone: 615.297.5166
Email: michael@daleandassociates.net

Surveyor
Campbell, McRae & Associates
Contact: John Hood
Phone: 615.298.2424
Email: cmas@att.net

Flood Note
This property is not located within a Flood Hazard Area as depicted on the current Flood Insurance Rate Map (FIRM) Number 47037C0234H dated April 5, 2017.

1311-1319 Baptist World Center

Parcels 99, 100 & 103 on Tax Map 71-14
Parcels 1E00100CO, 1E00200CO, 1E00200CO, 1E90000CO, 1F00100CO, 1F00200CO & 1F90000CO on Tax Map 71-14
Nashville, Davidson County, Tennessee

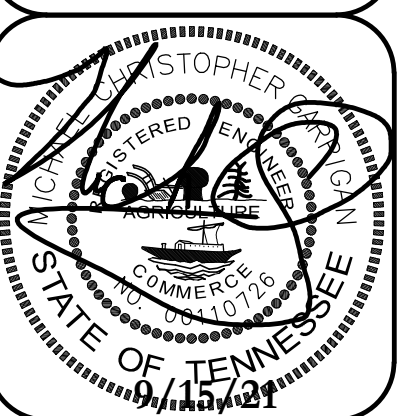

Intermediate Erosion Control Plan

Dale & Associates
516 Heather Place
Nashville, TN 37204
(615) 297-5166

Civil Engineering
Land Planning & Zoning
Surveying

D&A Project #20096
1311-1319 Baptist World Center

C3.0

SAGASER MARRIAGE TRUST, THE INSTRUMENT # 20180413-0034848 R.O.D.C., TN. PARCEL ID 07114009600 P.A.D.C., TN.

SAGASER MARRIAGE TRUST, THE INSTRUMENT # 20180413-0034848 R.O.D.C., TN. PARCEL ID 07114009700 P.A.D.C., TN.

SAGASER MARRIAGE TRUST, THE INSTRUMENT # 20180413-0034848 R.O.D.C., TN. PARCEL ID 07114009800 P.A.D.C., TN. ZONED IWD

"Pop-Up" Drain Top Elev = 432.0 Inv Elev = 430.5
Rip-Rap Outlet Protection Forebay #1 Bank=431.5 Stone Drop Level Spreader

Bioretention #1 Bank=431.5
SITE BENCHMARK MH TOP 425.56 NAVD 88 MH TOP 425.56 INV. IN 420.44 INV. OUT 420.36

Existing Storm Infrastructure Approved under SWGR 2021013411

Drainage Basin Summary

Runoff from Units 2-15 shall be discharged via splash pads onto the pervious pavers & then get into underdrains and drain to Forebay #2
Runoff from Unit 1 shall be collected in the roof leader system shown (on their north side) and discharge via the Pop-Up Drain into Forebay #1.

- In accordance with the Metro Stormwater Manual, Volume 1, Section 3.9, as-built certifications, MWS stormwater division must approve the following as-builts prior to issuance of the use & occupancy permit:
- underground detention
 - above ground detention
 - water quality infrastructure
 - public storm sewer infrastructure
 - cut & fill in the floodplain
 - sink hole alterations
 - bioretention areas

- A certification letter from TN registered P.E. stating that the site has been inspected and that the stormwater management system and stormwater control measures (both structural and non-structural) are complete and functional in accordance with the plans approved by MWS.
- Hydrologic and hydraulic calculations for as-built conditions, as required.
- As-built drawings showing the final topographic features of all these facilities. This shall include invert elevations of outlet control structures.
- Any deviations from the approved plans shall be noted on as-built drawings submitted.
- Copy of as-built plan in CAD file on a CD and should be registered to the TN State Plane Coordinate System, North American Datum 1983 (NAD83). Data should be placed in separate layers and should be labeled/framed for easy identification.
- Cut and Fill balance certification for floodplain and sinkhole alterations.
- Water Quality Buffers shall be surveyed and included with the as-built submittal.
- Any public (to become the responsibility of Metro to maintain) stormwater infrastructure shall be video-inspected to verify proper installation with video recording and any associated inspection report submitted as part of as-built record.
- Additional testing may be required as/if warranted by video inspection.

The engineer shall contact stormwater development review staff for submittal requirements.

Property Information
1311-1319 Baptist World Center
Nashville, Tennessee 37203
1.10 Total Acres
Council District 02: Kynzone Toombs

Owner/Developer
CW Building Group, LLC
1831 12th Avenue South, #105
Nashville, Tennessee 37203
Contact: Matt White
Phone: 615.330.1460
Email: matt@cwbuildinggroup.com

Civil Engineer
Dale & Associates
516 Heather Place
Nashville, Tennessee 37204
Contact: Michael Garrigan, PE
Phone: 615.297.5166
Email: michael@daleandassociates.net

Surveyor
Campbell, McRae & Associates
Contact: John Hood
Phone: 615.298.2424
Email: cmas@att.net

Flood Note
This property is not located within a Flood Hazard Area as depicted on the current Flood Insurance Rate Map (FIRM) Number 47037C0234H dated April 5, 2017.

Drawing Date:
September 2021

Revisions

1311-1319 Baptist World Center

Parcels 99, 100 & 103 on Tax Map 71-14
Parcels 1E00100CO, 1E00200CO, 1E00200CO, 1E90000CO, 1F00100CO, 1F00200CO & 1F90000CO on Tax Map 71-14
Nashville, Davidson County, Tennessee

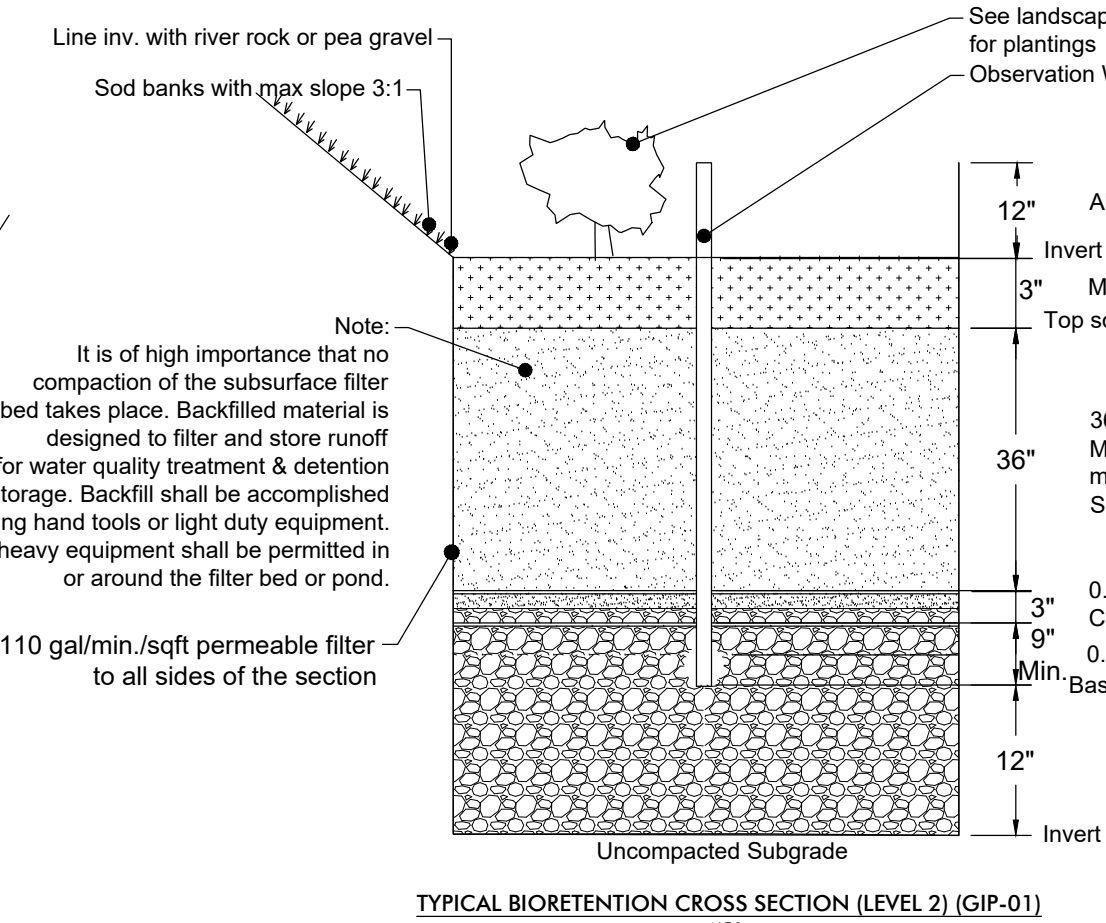
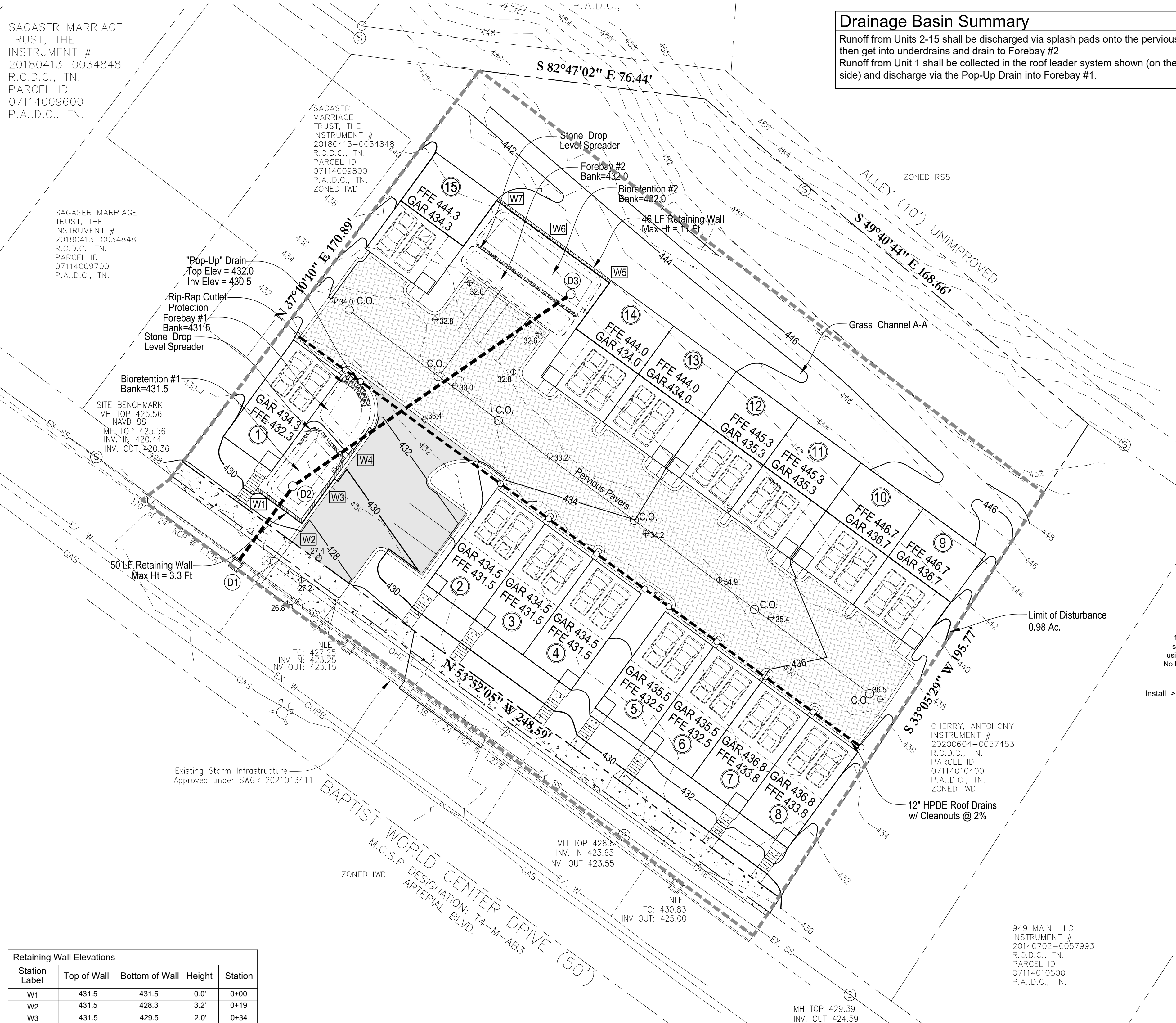

	BIORETENTION #1 LEVEL 2	BIORETENTION #2 LEVEL 2
Top of bank elev.	431.50	432.00
Above grade storage		
Invert (grade) elev.	430.00	430.50
3\"/>		

- BIORETENTION NOTES:**
- Bioremedia to consist of:
 - Max 70%-85% Sand, 10%-20% Silt + Clay with no more than 10% Clay, 5%-10% Organic Matter per Section 3, Table 1.2, Bioretention Design Criteria
 - No heavy machinery shall be used during installation of rain gardens
 - Backfilled material must remain uncompacted to ensure adequate void space for storage.
 - Contractor, engineer or owner shall notify MWS-development review at least 24 hours prior to the installation of the planting soil & filter bed/bioremedia.
 - At the completion of installation, the contractor shall collect one sample per bioretention bed for analysis & confirmation of the soil characteristics as defined by GIP-01, filter media and surface cover, section 6.6, page 20.

Contractor, engineer, or owners representative shall notify MWS-Development review at least 24 hrs prior to the installation of the planting soil filter bed. At the completion of installation, the above referenced person will collect one sample per bio-retention bed for analysis and confirmation of the soil characteristics as defined by GIP-01, filter media and surface cover, section 6.6, page 20.

Retaining Wall Elevations

Station Label	Top of Wall	Bottom of Wall	Height	Station
W1	431.5	431.5	0.0'	0+00
W2	431.5	428.3	3.2'	0+19
W3	431.5	429.5	2.0'	0+34
W4	432.0	432.0	2.0'	0+50
W5	443.0	432.0	11.0'	0+00
W6	442.5	432.0	10.5'	0+23
W7	442.0	432.0	10.0'	0+46

Drainage Structure Schedule

Structure Label	Structure Type	T.C. Elev.	Invert In	Invert Out
D1	Single Inlet	426.79	422.77	422.67
D2	Outlet Structure	431.00	424.75	424.65
D3	Outlet Structure	431.50	-----	426.25

Contractor to Field Verify the Casting Elevation of Structure D1 prior to Installation T.C. Elev for D1 measured from Existing Edge of Pavement

Pipe Schedule

Downstream Structure	Invert	Upstream Structure	Invert	Pipe Size	Length (ft)	Slope (%)
D1	422.77	D2	424.65	18" RCP	30	11.3
D2	424.75	D3	426.25	18" HDPE	77	0.45

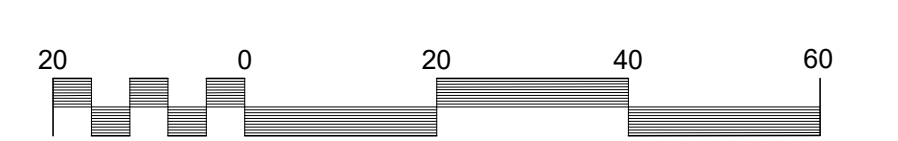
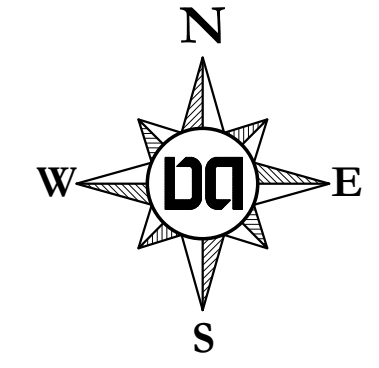
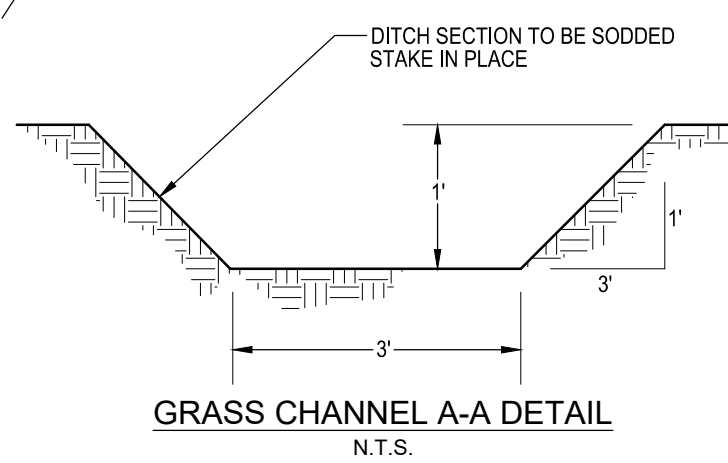
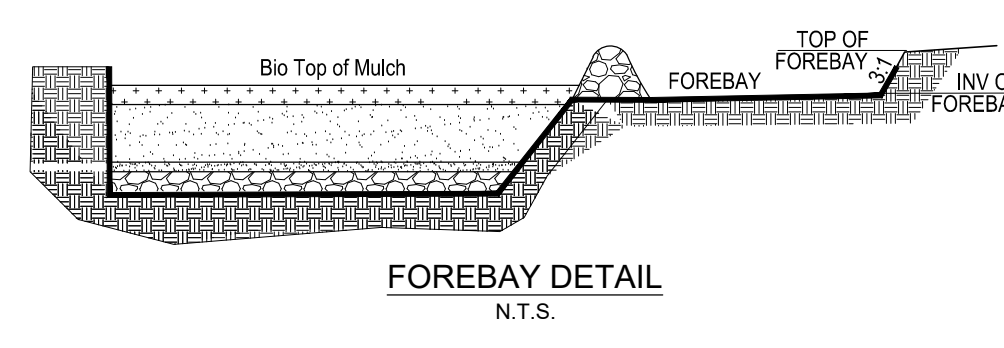
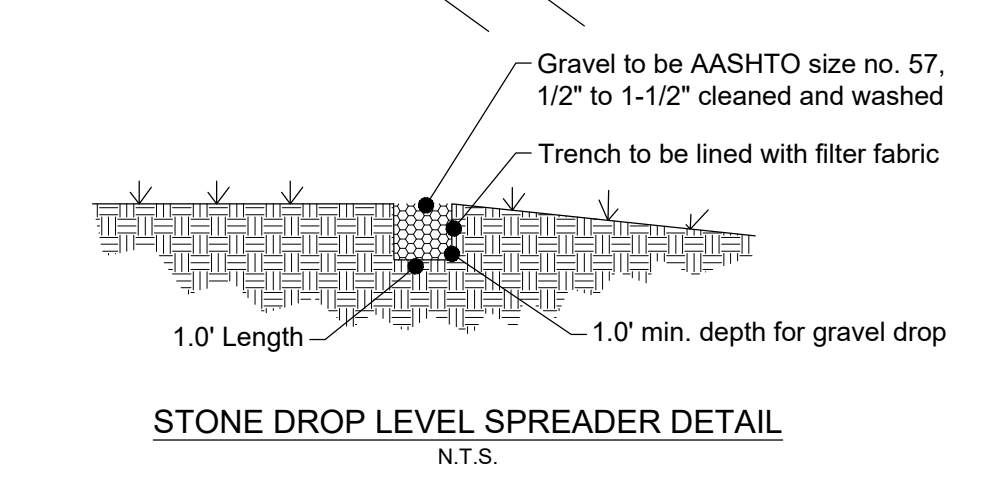
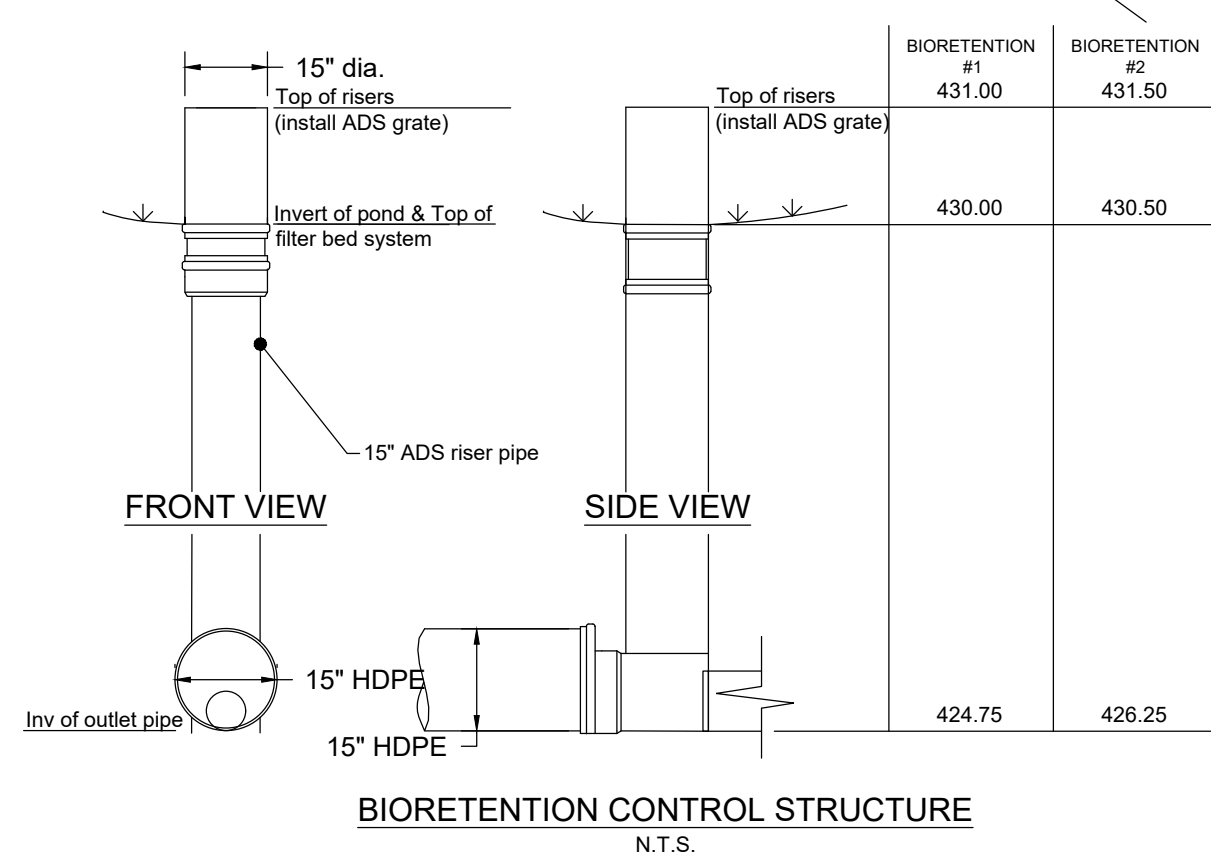

SCALE: 1" = 20'
SITE AREA (GROSS) = 47,867 Sq Ft (1.10 Acres)
SITE AREA (NET) = 46,416 Sq Ft (1.07 Acres)
DISTURBED AREA = 42,518 Sq Ft (0.98 Acres)

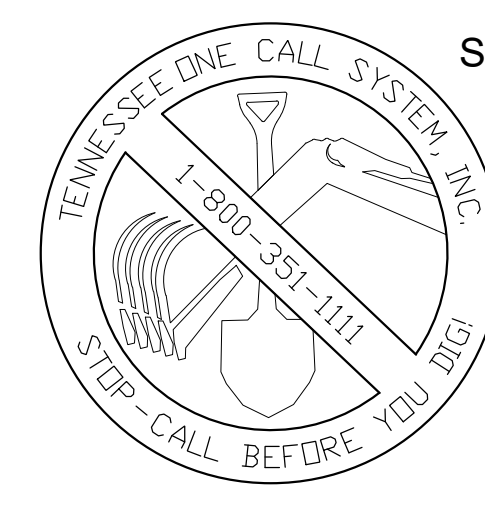

Permits

--

Dale & Associates
Civil Engineering
Land Planning & Zoning
Surveying

516 Heather Place
Nashville, TN 37204
(615) 297-5166

D&A Project #20096
1311-1319 Baptist World Center

C4.0

Site Grading & Drainage Plan

