



**Major Permit Modification Application
Yarnell Road Demolition Landfill
DML 47 000 0069**

Submitted to:

**Tennessee Department of Environment and
Conservation
Division of Solid Waste Management
3711 Middlebrook Pike
Knoxville, TN 37921**

Submitted by:

Waste Corporation of Tennessee, LLC
Yarnell Road Demolition Landfill
1550 Lamons Quarry Lane
Knoxville, TN 37932

Prepared by:

SCS ENGINEERS
2520 Whitehall Park Drive, Suite 450
Charlotte, NC 28173

January 23, 2018
Revised: March 30, 2018
Revised: June 11, 2018
Revised: October 5, 2018
File No. 02217306.02

**Offices Nationwide
www.scsengineers.com**



SCS ENGINEERS

January 24, 2018

Revised: March 30, 2018

Revised: June 11, 2018

Revised: October 5, 2018

File No. 02217306.02

Mr. Revendra Awasthi
Tennessee Department of Environmental Conservation
Division of Solid Waste Management
3711 Middlebrook Pike
Knoxville, TN 37921

Subject: Major Permit Modification Application
Phase F-2 Final Cover Grades
Yarnell Road Demolition Landfill, DML 47-0069

Dear Mr. Awasthi:

On behalf of Waste Corporation of Tennessee, LLC and the Yarnell Road Demolition Landfill, SCS Engineers is pleased to submit this revised Major Permit Modification Part II Application for the above referenced facility. The primary objective of this major permit modification is to facilitate stormwater drainage from Phase F-2 toward the Southern Sediment Basin #3 at the Yarnell Road Demolition Landfill. To accomplish this objective, the landfill final grades and stormwater drainage system were revised.

The enclosed report includes TDEC Forms CN-1509 and CN-0934, a narrative, engineering plans, and supporting calculations for the proposed modifications. The proposed changes to the final cover grades resulted in increasing the waste capacity in Phase F-2 by approximately 115,000 cubic yards. In addition, a check for \$2,000 was included with the original submittal dated January 24, 2018.

If you have any questions or need any additional information, please call either Eduardo Choquis (WCA) at 713-213-8299 or Steve Lamb (SCS Engineers) at 704-504-3107.

Sincerely,



Steven C. Lamb, PE
Project Director/Vice President
SCS ENGINEERS

cc: Paula Plont, TDEC
Bassam Faleh, TDEC
Eduardo Choquis, Waste Corporation of Tennessee, LLC
Adam Schrantz, Yarnell Road Demolition Landfill

Enclosures

October 5, 2018
File No. 02217306.02

Ms. Paula Plont
Division of Solid Waste Management
TDEC Knoxville
3711 Middlebrook Pike
Knoxville, TN 37921

Subject: Response to Technical Review – Proposed Major Permit Modification
Notice of Deficiency - Yarnell Road Demolition Landfill, DML 47-0069

Dear Ms. Plont:

On behalf of Waste Corporation of Tennessee, LLC and the Yarnell Road Demolition Landfill, SCS Engineers provides this letter in response to your August 21, 2018 letter for the above referenced project. Comments from your August 21, 2018 letter are provided below in **bold** text, followed by our response.

In addition, this letter also serves as our transmittal for the revised Major Permit Modification Application for the Yarnell Road Demolition Landfill.

COMMENTS AND RESPONSES

1. The calculation for the pond (Basin 3) on page 1 of 23 includes space up to the emergency spillway (at 1108) where the Rule requirement for ponds to hold the 24 hour/25-year volume should be limited to the elevation of the primary spillway (at 1107).

The calculation has been changed to reflect the volume up to the elevation of the principal spillway riser pipe at 1107.

2. **Sediment Basin is identified at times as 003 and at other times as 3. Sheets identifiers (sheets 2, 3 4, 5 & 10) and the term used in the narrative should match.**

The identifier has been revised to reflect “Sediment Basin 3” throughout the documents.

3. **Rule 0400-11-0 I-04(2)(i)3 states holding facilities must be designed to divert at least the peak flow resulting from a 24-hour, 100-year storm through the emergency spillway. Do not credit the primary spillway with any flow to properly determine the size, shape, and spillway rock lining specifications.**



The Emergency Spillway was re-designed to pass the peak flow resulting from a 24-hour/100-year storm event without allowing any credit through the Principal Spillway. Based on this calculation the bottom width of the emergency spillway is 18 feet. The calculated velocity passing 100 percent of the 24-hour/100-year storm event is 4.6 feet per second. Based on this velocity, riprap lining is not required. The spillway will be constructed with a grass cover.

- 4. Detail 5 on Sheet 8 does not include fabric because the detail was changed. Detail 5 should still include fabric as it is only a limited distance. This down-chute detail does not depict the 12-inch layer of vegetation soils nor does it show the 18-inch low permeable clay depth. Not including a fabric would need to be supported as the flow from the swales would be V-shaped and concentrated and likely to remain that way rather than spread out uniformly in those sections.**

Detail 5 on Sheet 8 has been modified to include erosion control matting and reference to the typical cover requirements.

- 5. Sheet 4 & 5 has a line type change at the 50-foot buffer line between grid lines E8-10.**

Sheets 4 & 5 have been revised.

- 6. Arrows miss the mark on sheet 7. They point to space, not a particular line.**

Cross section views have been revised to a 10:1 scale and leaders have been revised.

- 7. Sheet 5 phase Boundary line disappears near the south-east soil storage area to around south-west at ~ N4 grid line.**

The boundary line on sheet 5 has been revised.

- 8. Remove question marks on leachate line sheets 2 & 3. Notes were found relating this level of detail in actuality comes from a previous consultant(s).**

The question marks were removed from the leachate lines on Sheet 2 & 3

- 9. Will the stormwater flow from the side slope terrace into the proposed (2) 24-inch pipes? If so, please explain how. A detail should be provided.**

24-inch diameter pipes are only located from the drop inlet to the outfall into Sediment Basin 3. Detail 2, Sheet 11 shows how the side slope terrace will flow into the 18-inch diameter pipe.

- 10. Will flow from TB-6 get into (1) 18-inch pipe? If so, please explain how. A detail should be provided.**

Flow from TB-6 will flow into the 18-inch diameter pipe. Refer to Detail 1, Sheet 11.

11. Will flow from TB-5 get into (2) 18-inch pipes? If so, please explain how. A detail should be provided.

Detail 2, Sheet 11 shows how TB-5 will flow into the 18-inch diameter pipe.

12. One cross view shows the Feb 2018 existing grade is over the permitted grade. Station N3 between STA 5 & 11. Is this dirt or waste?

SCS reviewed all the surfaces and re-drafted the cross sections per Comment #26, including Station N 3+00. Based on the revised Station N 3+00 cross section, the 2018 existing grade is not over the permitted grade. However, we did notice that at Station E 11+00, the 2018 existing grade is over the permitted grade between stations N3+20 and N 5+20. Dirt was placed within this area to extinguish a previous subsurface oxidation event. This area is not above the proposed permit grade.

If the major permit modification is not approved, this area will be evaluated prior to closure. The existing grade will not be over the permitted final cover grade at closure. A note was added to Section E 11+00, Sheet 6C.

13. Detail 5 shown on Sheet 9 was not found on Sheet 5.

This has been corrected. Sorry for the confusion.

14. Detail 6 shown on Sheet 9 was not found on Sheet 5.

This has been corrected. Sorry for the confusion.

15. Remove figure label for the anti-vortex on Sheet 10.

The figure label has been removed on Sheet 10.

16. Sheet 7 has two solid lines named "exiting conditions." It appears one may be misplaced.

Cross section views have been revised to a 10:1 scale and leaders have been revised.

17. Filter fabric is necessary under the road. Please change the note that says "if necessary" on Detail 3 on Sheet 8.

Detail 3 on Sheet 8 has been revised.

18. Although increased waste is only being detailed within Phase F-2, areas of Phase F-1, Phase F-4 & Phase F-2 are essentially one unified footprint and, as such, some increased perspective from the scope should be provided with details like percent slope, slope length, flow path, flow velocities and ditch lining/armoring will need to be addressed in this modification.

The 2006 permit plans show benches and while it is understood that the highest areas of Phase F-2 and the highest portion of Phase F-4 are proposed to be replaced by swales, some review of grades and stormwater routing design for the lower elevations will need to be revisited. One item involves areas of the footprint along the road that were never developed. The plan sheets must depict the actual footprint. Those areas not developed that lie between the waste and the ditch will still need to be maintained and grassed. Include these slope lengths or alter the design such that the ditch is next to the waste. This major modification must accurately depict areas to be constructed or confirm areas will never be utilized.

The 2006 permit plans have benches which were to carry flow across several phases to the road ditch. This modification will need to accurately capture the present flow or provide an alternative design. Phase F-1 benches curve and drop quickly to the road ditch, and the recent heavy rains have caused erosion. The ditches have a steeper section and will need to have rock armoring designed and detailed on this drawing set. The area above or east of phase F-1 within phase F4 should be closely checked for grades as they seem to be steeper than industry standard 3H:1V. The division appreciates the early phased closure work, continued care and mowing at the site, however, any deviations from the 2006 permit must be fully captured in this current effort, even if no additional waste is being requested.

The request to expand the scope of the modification to the Closed Phase F-1 and adjacent F-4 is somewhat perplexing to WCA, particularly as part of a second request for additional information. The facility has extremely limited available airspace; thus, WCA respectfully requests to provide this information as part of a separate submittal to TDEC subsequent to the approval of the airspace increase being requested for Phase F-2.

19. The cost for 30 days of soil storage on-site is missing from the Closure Plan. This cost should be around \$97,500@ \$6.50/cyd.

We estimate a 10,000 square feet active face would receive 6 inches of soil twice during the 30-day period. This is approximately 400 cubic yards. We applied a factor of safety of 1.5. Therefore, 600 cubic yards was used in the Closure Cost Estimate. At a cost of \$6.50, this equates to \$3,900. A new line (Line 23c) was added to the Closure Cost Estimate to include this item.

20. Third Party cost to monitor construction during cap placement at the site is missing from the closure plan costs. The cost should be around \$49,000 at \$5,500/acre.

Lines 45, 70, and 145 cover third-party cost to monitor construction during cap placement. Our estimated costs for these items have been increased to average the \$5,500/acre TDEC guideline.

21. Please adjust the cost for the contractor equipment mobilization in the closure plan cost sheet to \$30,000.

The cost for construction equipment mobilization (Line 47) has been revised to \$30,000 in the Closure Cost Estimate.

22. The proposed drop pipes included in the design are not fully included to the extent depicted. There is only 400 linear feet included at \$25/ft., while the piping length is closer to 740 feet/ or \$18,500.

The lengths of 18-inch and 24-inch diameter stormwater pipes shown on the Phase F-2 drawings have been revised in Line 92 in the Closure Cost Estimate to 740 feet.

All piping and manholes shown along the road ditch must be specifically included in the closure cost sheet.

All proposed piping and manholes along the road ditch from the 2006 design have been added to the Closure Cost Estimate. See Lines 93, 93a and 93b.

23. The financial assurance figures for the leachate treatment costs are too low for the third party aspect. The State is currently using a flat rate of 20 cents per gallon to cover this obligation in the bonds. Using the amount provided, please add \$400,000 as part of the closure plan costs.

We respectfully disagree with your disposal cost of \$0.20 per gallon in the Post Closure Cost Estimate, however we understand your concerns with a third party entity taking over leachate management at the site. Currently, the site is discharging leachate to the West Knox Sewer District, which is a third party entity, at a cost of \$0.005 per gallon. We propose a cost of \$0.10 per gallon. In addition, the annual volume of leachate for the post closure period was estimated to be 1,400,000 gallons per year. This volume was derived by taking the actual previous 12 months (1,727,423 gallons) and reducing that by 20 percent. The 20 percent reduction is based on the fact a portion of Phase F-2 was recently excavated with no waste and a leachate collection pipe (which increased leachate volume during this period), and secondly, once the final cap is in placed in Phase F-2, the volume of leachate will decrease.

24. Include a cost for the leachate collection system during the post-closure period at \$20,000 per year.

Line 46 in the Post Closure Cost Estimate has been increased from \$16,500 to \$20,000 per year.

25. Please adjust the cost for construction management & administration in the closure plan cost to \$30,000.

The construction management & administration estimate (Line 71) was increased from \$7,745 to \$30,000 as requested in the Closure Cost Estimate.

26. Cross sectional view sheets 6A & 6B scale should be more typical 10:1 or 5:1 scale to enable easier review of the identified lines.

Cross section views have been revised to a 10:1 horizontal scale.

27. Check the watershed area of the sediment pond 3.

The drainage area contributing to Sediment Basin 3 is approximately 7.5 acres. A drainage map illustrating the drainage area is provided in revised Stormwater Calculations.

What is the intended flow for the area under the access road south slope F-2? Will that be directed to pond 3?

The small area under the access road along the southwest portion of Phase F-2 will be diverted to the west through the undisturbed woodlands area. This flow will be intercepted by the existing drainage bench in Phase F-1. From here the flow is diverted into Sediment Basin 1. A new stormwater channel has been added to Sheet 5.

28. Need to add a sedimentation forebay to the sediment pond 3.

A sediment forebay has been added to Sediment Basin 3 on Sheet 5. See Detail 3, Sheet 11 for a detail of the forebay.

29. Sheet 05-Stormwater Management Plan:

- **Include a full profile of the proposed 2-18 inch down slope pipes which transition into 2-24 inch down-slope drain pipes.**

A full profile of the proposed twin 18-inch diameter down chutes and twin 24inch diameter pipes is provided on Sheet 12.

- **Include a profile of the 1-18 inch down-slope pipe.**

A full profile of the proposed 18-inch diameter down chute is provided on Sheet 12.

- **The length of the side slope tack-on berm (TB) is approximately 1000 feet too long. To avoid erosion and possible washout of the TB consider limiting the length of TB to 400 feet to 500-feet max.**

Reducing the length of the side slope tack-on berm was considered. However, with the existing configuration of the northern slope and the effort to convey runoff to Sediment Basin 3 providing piping is not believed to be a feasible alternative. Our calculations provide that the proposed slopes and erosion control matting are sufficient to avoid erosion and washout of the tack-on berms. A 1-ft freeboard is maintained during the 24-hour/25-year storm event.

30. Sheet 10 - Details:

- **Need to add an anti-seep collar detail**

An anti-seep collar detail was added to Sheet 10.

- **Add maximum elevation of both the 25-yr, 24-hr and 100-yr, 24-hr storm events.**

The maximum elevations of the 24-hour/25-year and 24-hour/100-year storm events have been added to Detail 3, Sheet 11.

31. The Sediment Pond's barrel pipe is undersized, because the inlet controls the design flow, not an outlet. The headwater depth at the inlet, which is 10-feet, should be used in the design calculations, not 18-feet. Please check.

The calculation for the barrel pipe was revised and the barrel pipe was changed to a 30-inch diameter pipe.

32. Provide soil loss calculations.

The Revised Universal Soil Loss Equation (RUSLE) was used to predict soil loss for Phase F-2. One calculation was performed prior to closure assuming bare ground and one calculation was performed assuming good vegetation after closure. The pre closure analysis predicted soil loss equal to 14 tons/acre/year and the post closure analysis predicted soil loss equal to 1.8 tons/acre/year. (See Appendix B, Attachment 5).

33. Slope stability calculations: The rationale used for selecting the critical cross section should be provided with references used in the computation.

Section E 10+00 was selected as the critical cross-section as it reaches the highest elevation at El. 1240, near the maximum elevation, and represents the longest slope at approximately 280 feet from crest to toe at 3:1 slope. Based on our experience, this section will have the lowest factor of safety of other landfill slopes and is thus the critical slope. This cross-section also depicts the bedrock surface, which has a high point near the toe of the new waste mass.

The following note has been added to Sheet 4 *“Section E 10+00 was selected as the critical cross-section as it reaches the highest elevation at El. 1240, near the*

maximum elevation, and represents the longest slope at approximately 280 feet from crest to toe at 3:1 slope”

34. Provide stability calculations applicable to within the waste mass.

Computer output files for the calculated slope stability factors of safety of the critical cross section are provided in Appendix C “PCSTABL5M Calculations.” This appendix contains graphical representations of the slope stability section analyzed along with input data of the slope boundary coordinates, the material types included, and their geotechnical properties. The outputs files also include numerical values of failure surface coordinates, water force information, earthquake forces, surcharges, and factor of safety values for the 10 lowest surfaces.

PCSTABL5M is a limit-equilibrium slope stability model developed by Purdue University in 1985 which SCS has used for numerous landfill stability evaluations. For this evaluation, the factors of safety were computed using the Modified Bishop Method, which breaks each slope into vertical slices to calculate the factor of safety against shear failure. For each slope modeled, up to 2,000 shear failure surfaces were analyzed and the 10 shear surfaces with the lowest factor of safety are depicted on the attached graphical outputs. The lowest factor of safety is shown in red (labeled “a”) in the upper left corner and corresponds to the circular surface also shown in red, along with red arrows identifying the limits of the failure surface.

35. The provided critical section is not legible. A full-size drawing (1" = 100'H, 1"=10'V, preferred) should be provided showing the profile of the selected critical cross section with the lowest factor of safety and the following details:

- The geometry of the waste mass, the proposed base grade, and the final cover systems.
- The actual elevations and stations of the selected profile (no assumed elevations).
- The material properties of the waste and the final cover system.
- The temporal high phreatic and piezometric surfaces.
- The soil profile/strata beneath the bottom of the base grade.
- Failure slip surfaces for all failure types (global, Veneer, and within the waste mass, seismic) with a factor of safety values shown.

The geometry of the waste mass, final cover system, foundation layer, bedrock surface, and groundwater surface are depicted on the revised graphical output files for each slope conditions model. The horizontal and vertical scales are both approximately 1"=100' scales, which represents a natural 1:1 ratio and is recommended for this type of analysis as it shows the shear surfaces in proper scale to materials comprising the slope. Exaggerating the vertical scale by 10X, or 1"=10', is not recommended as it would be more difficult to assess the failure surface orientation.

Material properties for the cover soil, C&D waste, foundation material and bedrock were based on review of available information. We assumed a nominal low cohesion value of 200 psf for the cover soil and foundation materials, but 0 psf for the C&D waste. For

pseudo-static stability, we assumed a seismic acceleration factor of $a=0.30g$ based on the USGS Seismic Hazards Map, as shown below.

The revised slope stability calculations with output graphics are provided in Appendix C of the Major Permit Modification Application.

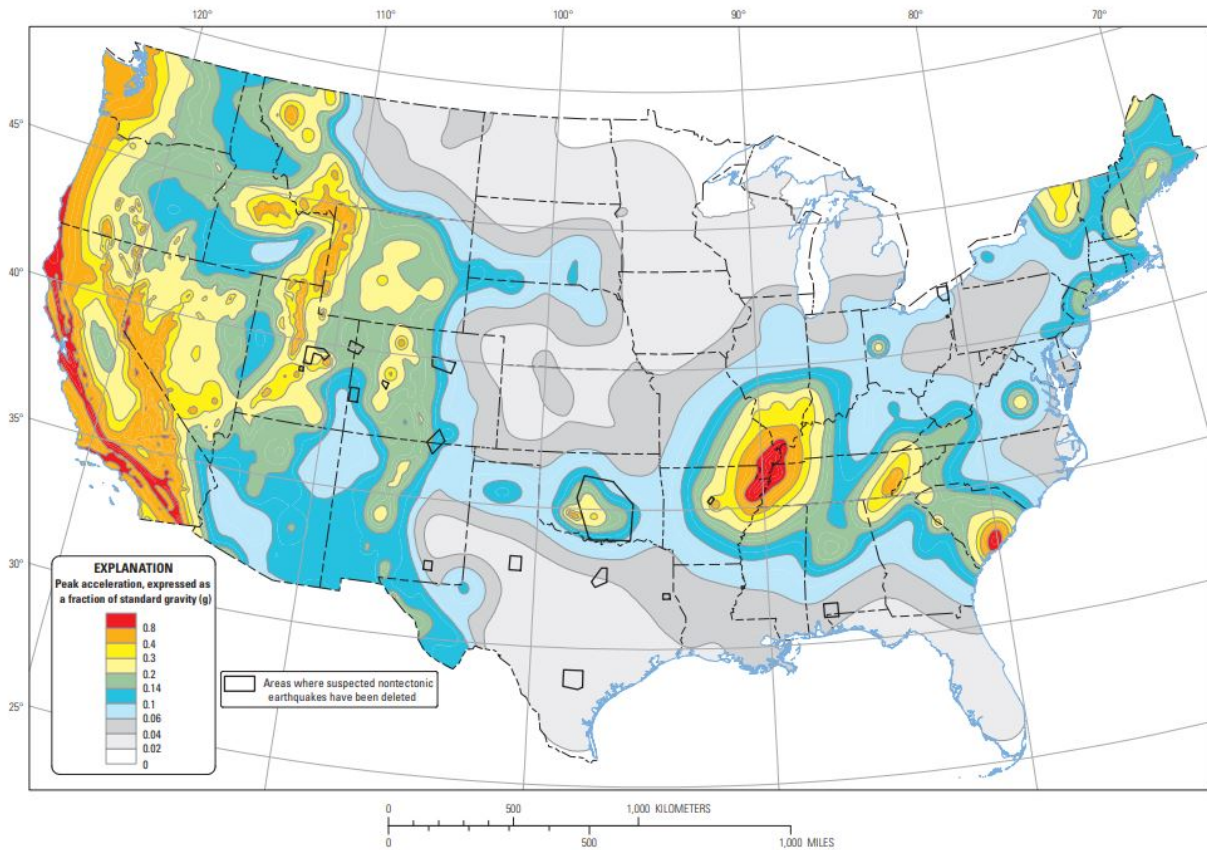

The soil types and respective material properties are indicated directly on the PCSTABL5M output graphics in the upper left corner, and in the printed output files, but are summarized below:

SLOPE STABILITY MATERIALS AND PROPERTIES

Soil Type No.	Soil Description (PCSTABL)	Total Unit Wt (pcf)	Saturated Unit Wt. (pcf)	Cohesion (Intercept) (psf)	Friction Angle (deg)	Piez Surface*
1	Final Soil Cap (CovrSoil)	115	115	200	26.0	W1
2	C&D Waste (Waste)	63	63	0	35.0	W1
3	Foundation Layer (FdtnSoil)	120	120	200	33.0	W1
4	Bedrock (Bedrock)	155	155	200	45.0	W1

*Piezometric surface at base on landfill

36. Provide a summary table describing/showing the results of the stability calculations.

A summary table is provided below:

SLOPE STABILITY SUMMARY TABLE

Slope Analysis	Static FS	Seismic FS (a=0.30g)	Narrative Discussion/Comments
Final Slope Stability Analysis, Circular Failure Surface, Total Slope	1.82	1.0	This model computes the FS for a circular failure surface that initiates upslope of the bedrock feature, assumes static and pseudo-static (a=0.30g seismic) conditions.
Final Slope Stability Analysis, Static, Top Slope -Large	2.21	1.05	This model computes the FS for a circular failure surface that initiates on either side of the slope crest and extends to the toe of slope, near the shallow rock feature.
Final Slope Stability Analysis, Circular Failure Surface, Top Slope - Small	2.23	1.06	This model computes the FS for a circular failure surface that initiates downslope of the crest and extends to near the bedrock feature.

Based on the three scenarios modeled, the lowest factors of safety are for a circular failure surface that initiates near the bedrock feature, but exceed 1.5 and 1.0 for static and pseudo-static (i.e., seismic) conditions, respectively, and deemed acceptable.

37. Provide a narrative for each modeling scenario used in the computations.

See "Narrative/Discussion/Comments" column in the summary table above.

38. Program output data: Check the limit sets for the failure surfaces. Some of the failure surfaces extended beyond the final crown (topdeck).

PCSTABL5M employs an automated search routine that analyzes up to 2,000 failure surfaces initiated between the two red dots shown on the output files, while the yellow dots represent the end points of the surfaces. That some surfaces extend beyond the final crown (but, still between the red dots) is to make sure that the lowest factor of safety surface is captured by the model.

39. Since the friction angle of the final cover soil is less than the friction angle of the C&D waste, does it warrant a veneer failure analysis? If so, please provide a veneer stability analysis to ensure the final cover system is stable. If not, provide justification?

A veneer stability analysis, based on methods developed by R.M. Koerner, and T-Y. Soong, 1998. "Analysis and Design of Veneer Cover Soils", has been added to the revised slope stability calculations provided in Appendix C of the Major Permit Modification Application. The analysis, which assumes a nominal soil cohesion of 200 psf and 26 degrees friction for the cover soil, and slope length of 300 feet, yields a static veneer factor of safety of 1.56.

As stated herein our responses have been incorporated into the revised Major Permit Modification Application's permit narrative, permit drawings and calculations. If you have any questions or need any additional information, please call either Eduardo Choquis (WCA) at 713-213-8299 or Steve Lamb (SCS Engineers) at 704-504-3107.

Sincerely,

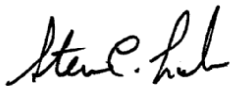

Steven C. Lamb, PE
Project Director/Vice President
SCS Engineers

ojh/scl

cc: Abe Almassi, TDEC
Eduardo Choquis, Waste Corporation of Tennessee, LLC
Andy Schrantz, Yarnell Road Demolition Landfill

Encl.

SOLID WASTE FACILITY MODIFICATION NOTIFICATION FORMS



STATE OF TENNESSEE
 DEPARTMENT OF ENVIRONMENT AND CONSERVATION
 DIVISION OF SOLID WASTE MANAGEMENT
 WILLIAM R. SNODGRASS TENNESSEE TOWER
 312 ROSA L. PARKS AVENUE, 14TH FLOOR
 NASHVILLE, TN 37243

SOLID WASTE FACILITY MODIFICATION NOTIFICATION

PERMIT #
DATE
TDEC USE ONLY <input type="checkbox"/> MINOR <input type="checkbox"/> MAJ

1 - FACILITY TYPE	2 - TYPES OF MODIFICATIONS		NUMBER OF MODIFICATIONS
<input type="checkbox"/> CLASS I <input type="checkbox"/> CLASS II <input checked="" type="checkbox"/> CLASS III <input type="checkbox"/> COMPOST	<input type="checkbox"/> OPERATIONS <input checked="" type="checkbox"/> NARRATIVE CHANGE <input checked="" type="checkbox"/> ENGINEERING PLANS <input type="checkbox"/> GROUND WATER PROGRAM	<input type="checkbox"/> CONSTRUCTION QUALITY ASSURANCE PLAN <input checked="" type="checkbox"/> CLOSURE / POST CLOSURE PLAN <input type="checkbox"/> OTHER (SPECIFY) _____	

3 - FACILITY INFORMATION			
FULL LEGAL NAME OF FACILITY		COUNTY	
Yarnell Road Demolition Landfill		Knox	
PHYSICAL LOCATION ADDRESS (GIVE DIRECTIONS IF NECESSARY)		CITY	STATE ZIP
1550 Lamons Quarry Lane		Knoxville	TN 37932

4 - CONTACT PERSONS			
FACILITY MANAGER OR SITE OPERATOR		PHONE	EMAIL
John Anderson		(865) 740-2673	janderson@wcamerica.com
RESPONSIBLE OFFICIAL		PHONE	EMAIL
Bob Shires		(352) 377-0800	bshires@wcamerica.com
FACILITY MAILING ADDRESS		CITY	STATE ZIP
1550 Lamons Quarry Lane		Knoxville	TN 37932

5 - MODIFICATION INFORMATION	
DESCRIPTION OF MODIFICATION	REASON FOR MODIFICATION
1. Modifying final cover grades in Phase F-2.	To increase capacity in Phase F-2.
2. Modifying Closure and Post-Closure Plan and updating Closure and Post-Closure Cost Estimates	Revising final cover grades in Phase F-2. The Phase F-2 disposal area is also being reduced in size. To reflect site changes.
3.	

6 - CERTIFICATION REQUIRED	
I certify under penalty of law that this document and all attachments were prepared by me, or under my direction or supervision. The submitted information is to the best of my knowledge and belief, true, accurate, and complete. I am aware that there are significant penalties for submitting false information, including the possibility of fine and imprisonment. As specified in Tennessee Code Annotated Section 39-16-702(a)(4), this declaration is made under penalty of perjury.	
 SIGNATURE OF RESPONSIBLE OFFICIAL	Bob Shires PRINTED NAME
Region Vice President TITLE	11/16/18 DATE SIGNED

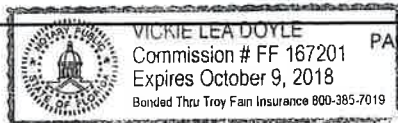

vickieleadoyle



**TENNESSEE DEPARTMENT OF ENVIRONMENT AND CONSERVATION
DIVISION OF SOLID WASTE MANAGEMENT
312 Rosa L. Parks Avenue, 14th Floor
Nashville, TN 37243
SOLID WASTE APPLICATION FILING/PROCESSING FEE**

<p>1. Facility Information</p> <p>Yarnell Road Demolition Landfill</p> <hr/> <p>Full Legal Name of Facility</p> <p>1550 Lamons Quarry Lane</p> <hr/> <p>Mailing Address</p> <p>Knoxville, Tennessee 37932</p> <hr/> <p>City, State, Zip Code</p>	<p>2. Permittee Information</p> <p>Waste Corporation of Tennessee, Inc.</p> <hr/> <p>Permittee (Name/Legal Entity)</p> <p>1550 Lamons Quarry Lane</p> <hr/> <p>Mailing Address</p> <p>Knoxville, Tennessee 37932</p> <hr/> <p>City, State, Zip Code</p> <p>(865) 740-2673</p> <hr/> <p>Telephone Number of Permittee</p>			
<p>3. Physical Location/Directions to Facility</p> <p>From Knoxville. I-40 W TN-162 N Left on Carmichael Road Right on Yarnell Road Left on Lamons Quarry Lane</p>	<p>4. Type Facility and Fee Due:</p> <p><input type="checkbox"/> New Disposal Facility*</p> <p style="margin-left: 20px;"><input type="checkbox"/> Class I <input type="checkbox"/> Class II</p> <p style="margin-left: 20px;"><input type="checkbox"/> Hydrogeology\$ 4,000</p> <p style="margin-left: 20px;"><input type="checkbox"/> Construction Plan Review... 6,000</p> <p style="margin-left: 20px;"><input type="checkbox"/> Class III 3,000</p> <p style="margin-left: 20px;"><input checked="" type="checkbox"/> Major Modification 2,000</p> <p style="margin-left: 20px;"><input type="checkbox"/> Processing Facility 1,000</p> <p style="margin-left: 20px;"><input type="checkbox"/> Transfer of Ownership..... 1,000</p> <p style="margin-left: 20px;"><input type="checkbox"/> Transfer Station 500</p> <p>*Includes Lateral Expansions</p>			
<p>5. Total Site Acres (If Disposal Operation):</p> <p align="center">24.32</p>	<p>6. Amount of Fee Enclosed:</p> <p align="center">\$ 2,000</p>			
<p>7. Total Acres In Landfill Footprint:</p> <p align="center">58.15</p>	<p>8. Type and Size Facility If Processing Facility:</p>			
<p>9. I certify under penalty of law that this document and all attachments were prepared by me, or under my direction or supervision in accordance with a system designed to assure that qualified personnel properly gathered and evaluated the information submitted. Based on my inquiry of the person or persons who manage the system, or those persons directly responsible for gathering the information, the information submitted is, to the best of my knowledge and belief, true, and accurate, and complete. I am aware that there are significant penalties for submitting false information, including the possibility of fine and imprisonment. As specified in Tennessee Code Annotated Section 39-16-702(a)(4), this declaration is made under penalty of perjury.</p> <p align="center"> Bob Shires Region Vice President </p> <hr/> <p align="center"> Print or Type Name Title </p> <hr/> <p align="center"> 1/16/18 </p> <hr/> <p align="center"> Signature Date </p>				
FISCAL SERVICES USE ONLY BELOW THIS LINE				
ASSIGNED FACILITY ID NUMBER:				
CD Number	Date Received	Amount	Receipt #	Comments



(continued on reverse)

VickieLeaDoyle

EXECUTIVE SUMMARY

The primary objective of this major permit modification is to facilitate stormwater drainage from Phase F-2 toward the Sediment Basin #3 at the Yarnell Road Demolition Landfill. To accomplish this objective, the landfill final grades and stormwater drainage system were revised. The enclosed report provides a narrative, engineering plans, and supporting calculations for the proposed modifications. The proposed changes to the final cover grades resulted in increasing the waste capacity in Phase F-2 by approximately 115,000 CY. The remaining three phases (Phases F-1, F-3, and F-4) are closed and are not modified by this application.

The proposed modification includes upgrades to the stormwater drainage system. As per the request from the Tennessee Department of Environmental Conservation (TDEC), an effort has been made to redirect runoff to Sediment Basin #3. All proposed drainage structures have been designed to meet the volume of the 24-hour, 25-year storm event.

Since portions of the final grades have been revised, slope stability analyses of the final landfill geometry were conducted using PCSTABL5M3. The analyses determined the minimum Factor of Safety meets the Division of Solid Waste Management (DSWM) requirements. The analyses includes loading scenarios for both earthquake (pseudo-static) and non-earthquake (static) conditions.

**Major Permit Modification Application
Yarnell Road Demolition Landfill**

Submitted to:

**Tennessee Department of Environment and Conservation
Division of Solid Waste Management**
3711 Middlebrook Pike
Knoxville, TN 37921

Presented To:

**Waste Corporation of Tennessee, LLC
Yarnell Road Demolition Landfill**
1550 Lamons Quarry Lane
Knoxville, Tennessee 37932

Prepared by:

SCS ENGINEERS
2520 Whitehall Park Drive, Suite 450
Charlotte, NC 28173

January 23, 2018
Revised: March 30, 2018
Revised: June 11, 2018
Revised: October 5, 2018

File No. 02217306.02

Table of Contents

Cover Letter

Section	Page
Solid Waste Facility Modification Notification Forms.....	i
Executive Summary.....	ii
1.0 INTRODUCTION.....	1
1.1 Responsible Party	1
1.2 Facility Location.....	1
1.3 Items Covered in this Permit Modification.....	2
1.4 Items Not Covered in this Modification.....	2
2.0 PROPOSED MODIFICATIONS TO PHASE F-2 FINAL COVER GRADES.....	3
2.1 Overview	3
2.2 Methods and Sequence of Operation	3
2.3 Anticipated Waste Volumes and Characteristics.....	3
2.4 Summary of Area to be Filled and Permitted.....	4
3.0 ENGINEERING ANALYSIS	5
3.1 Stormwater Management System.....	5
3.1.1 Sediment Pond #3 Modification	6
3.2 Slope Stability Analysis	6
3.2.1 Method of Analysis.....	6
3.2.2 Soil and Landfill Geotechnical Parameters.....	7
3.2.3 Results.....	8
3.3 Soil Requirements.....	8
4.0 CLOSURE AND POST CLOSURE PLAN	9
4.1 Closure Plan	9
4.1.1 Facility Description.....	9
4.1.2 Closure Schedule	9
4.1.3 Placement of Final Cover	9
4.1.4 Stormwater Management.....	10
4.1.5 Vegetation.....	10
4.1.6 Leachate Management	10
4.1.7 Landfill Gas Management.....	10
4.2 Post Closure Plan.....	11
4.2.1 Post Closure Activities.....	11
4.3 Closure and Post Closure Cost Estimates	11

List of Tables

No.		Page
1	Summary of Waste Disposal Areas	4
2	Drainage Area and Peak Flow for Proposed Stormwater Controls	5
3	Summary of Slope Stability Analyses	7
4	Material Properties for Slope Stability Analyses	8
5	Ground Cover Seeding, Rate/Acre	10

Appendices

A	Permit Drawings
B	Stormwater Calculations
C	Slope Stability Calculations
D	Closure and Post Closure Cost Estimates

1.0 INTRODUCTION

This Part II Major Permit Modification application is submitted to the Tennessee Department of Environment and Conservation Division of Solid Waste Management with the objective of improving stormwater drainage from Phase F-2 toward the existing Southern Sediment Basin #3 at the Yarnell Road Demolition Landfill (Landfill). To accomplish this objective, the landfill's final grades and stormwater drainage system have been revised as presented herein. The Landfill is a Class III disposal facility and operates under Permit # DML 47 000 0069. This application was prepared by SCS Engineers on the behalf of Waste Corporation of Tennessee, LLC and the Yarnell Road Demolition Landfill.

The Landfill was originally permitted in April 1999. From 1999 to 2002, the Landfill was operated by Farragut Excavating Company and from 2002 to the present, the Landfill has been operated by Waste Corporation of Tennessee, LLC (WCT). The original landfill permit consisted of three phases (Phase F-1, F-2, and F-3). In 2005, a major permit modification application to add Phase F-4 was submitted and approved.

Phases F-1, F-3, and F-4 are currently closed. Phase F-2 is the sole remaining disposal area with remaining capacity to accept waste. Based on our analysis, as of January 1, 2018 approximately 118,350 cubic yards of airspace remain under the current permit.

1.1 RESPONSIBLE PARTY

This Part II Major Permit Modification application is submitted by Waste Corporation of Tennessee, LLC. The mailing address for Waste Corporation of Tennessee, LLC. is 1550 Lamons Quarry Lane, Knoxville, Tennessee 37932. The responsible official regarding the landfill is Bob Shires, or his designated agent.

1.2 FACILITY LOCATION

The Yarnell Road Demolition Landfill is located at:

1550 Lamons Quarry Lane
Knoxville, Knox County, Tennessee 37932
Latitude N35.55.12, Longitude W84.09.53

1.3 ITEMS COVERED IN THIS PERMIT MODIFICATION

The objective of this major permit modification is to revise final cover grades to improve stormwater drainage from Phase F-2 toward the existing Southern Sediment Basin #3 and revise the stormwater management system. As part of this modification, slope stability for Phase F-2 was also assessed.

Specific items included in this application include:

TECHNICAL ITEM	APPENDIX/Section
Engineering Drawings including revised Phase F-2 Final Cover Grading Plan, Details and Cross Sections	A
Stormwater Management Calculations	B
Slope Stability Modeling Results	C
Updated Closure and Post Closure Plan	Section 4.0
Updated Financial Assurance Closure and Post Closure Estimates	D and Section 4.4

1.4 ITEMS NOT COVERED IN THIS MODIFICATION

Since the proposed changes include modifying the final cover grades in Phase F-2 only, the following plans/programs are not impacted and, therefore not addressed in this application:

- Hydrogeological Report
- Quality Assurance and Quality Control Plan
- Groundwater Monitoring Program
- Random Inspection Program

2.0 PROPOSED MODIFICATIONS TO PHASE F-2 FINAL COVER GRADES

2.1 OVERVIEW

The proposed final cover grades described in this modification apply to the Phase F-2 disposal area and are based on 3 horizontal to 1 vertical (3H:1V) slopes with tack-on berms to improve stormwater runoff. The current permit final cover grades are 3H:1V with benches. The maximum elevation was also raised from elevation 1230 to 1244 feet above mean sea level (msl). This elevation change increases waste capacity as discussed in Section 2.3

2.2 METHODS AND SEQUENCE OF OPERATION

The existing permit is comprised of Phases F-1, F-2, F-3, and F-4. Current operations are in Phase F-2. This proposed major modification will address a vertical expansion in Phase F-2. Phase F-1, F-3, and F-4 are closed.

2.3 ANTICIPATED WASTE VOLUMES AND CHARACTERISTICS

The existing Yarnell Road Demolition Landfill is a Class III disposal facility. The proposed vertical expansion area shall only accept those materials which are allowed in an approved Class III landfill.

The increase in the maximum elevation combined with the replacement of traditional benches with tack-on berms provides for an increased design capacity in Phase F-2 by approximately 115,000 cubic yards. Based on the current estimated disposal rate of 250 tons per day (5 days per week) and an in-place density of 1,350 pound per cubic yard, the proposed modification increases the life expectancy in Phase F-2 by approximately 14.3 months.

As of October 1, 2018, the estimated remaining capacity without the approval of this modification is approximately 49,000 cubic yards, or about 6 months. Including the increased capacity from revising the final grades as described herein, the total remaining capacity and life expectancy as of October 1, 2018 would be 164,000 cubic yards and 21 months, respectively. Therefore, it is anticipated that Phase F-2 will reach capacity about June 2020.

2.4 SUMMARY OF AREA TO BE FILLED AND PERMITTED

The overall facility property is approximately 58 acres in area. The current permitted waste disposal footprint covers approximately 24.34 acres as shown in **Table 1** below.

Table 1. Summary of Waste Disposal Areas

Phase	Waste Footprint Area (acres)	Status
F-1	6.25	Closed
F-2	9.15	Open
F-3	5.32	Closed
F-4	3.62	Closed

It should be noted that a small area in Phase F-4 (approximately 0.47 acres) does not contain waste. This area is noted on Sheet 2 and 3.

In addition to the four waste disposal areas, the facility includes sediment basins, stormwater control structures, a leachate holding tank, scale house, and a maintenance building. The site also includes 6 groundwater monitoring wells.

3.0 ENGINEERING ANALYSIS

This section covers the engineering analysis in support of the vertical expansion within Phase F-2. The analysis addresses stormwater management, slope stability associated with the Phase F-2 modification, and soil requirements.

3.1 STORMWATER MANAGEMENT SYSTEM

The Stormwater Management Plan is illustrated on Drawing 5, **Appendix A**. The proposed primary stormwater management controls include tack-on berms, pipe down-chutes, Access Road Ditch, South Perimeter Channel, and Southeast Perimeter Channel. In addition, a drop inlet structure with two 24-inch diameter culverts are proposed to convey runoff into Sediment Basin #3.

SCS calculated the peak storm runoff for each of the above permanent stormwater control structures. The hydrological analysis for the 25-yr/24-hr storm event was performed using a Windows-based Technical Release No. 55 (TR 55) model. The 25-yr/24-hr storm event is 5.5 inches. The *Hydraflow* model was used to size the proposed structures. The hydrological analysis is provided in **Appendix B**. The peak flows and drainage areas for the major components are summarized below in **Table 2**. Using the peak runoff rates, a hydraulic analysis for each component was performed and calculations are included in **Appendix B**.

**Table 2 – Drainage Area and Peak Flow
 for Proposed Stormwater Controls**

Structure	Drainage Area (acres)	25-yr/24-hr Peak Runoff Rate (cfs)
Tack on Berm ^[1]	1.69	10.12
Single 18-inch Downchute Pipe	1.80	10.49
Twin 18-Inch Downchute Pipes	2.56	15.19
Access Road Ditch	1.07	6.41
South Perimeter Channel	2.96	17.43
Southeast Perimeter Channel	3.61	21.22
Proposed Twin 24 Inch Culverts to Sed. Basin 3	6.17	36.41

[1] Tack-on berm #2, which has the largest drainage area, was used to size all proposed tack-on berms.

3.1.1 Sediment Pond #3 Modification

As a result of revising the final grades and drainage components within Phase F-2, the capacity of existing Sediment Pond #3 will need to be increased. Following the closure of Phase F-2, the area contributing stormwater into Pond #3 will be approximately 7.51 acres. Calculations for Pond #3 are provided in **Appendix B**. Results of the calculations are summarized below:

- Pond Storage Volume to Emergency Spillway– 5,000 CY
- Wet Storage Volume (el. 1094 to el. 1100) – 511 CY
- 24-hr/25-yr Runoff Volume – 3,735 CY
- Pond Storage Volume to top of Principal Spillway (el 1107) – 3,768 CY
- 24-hr/25-yr Peak Inflow – 44.22 cfs
- 24-hr/100-yr Peak Inflow – 55.23 cfs

The bottom elevation of Sediment Pond #3 shall be 1094 ft msl. A sediment cleanout marker will be installed on the pond bottom. The landfill will maintain and clean out the pond whenever the sediment depth approaches the 4-ft mark on the cleanout marker.

A new principal spillway riser and barrel will be installed to pass the 25-yr/24-hr peak flow rate. The riser will be a 36-inch diameter CMP pipe and the barrel will be a 30-inch diameter CMP pipe, or similar.

3.2 SLOPE STABILITY ANALYSIS

A static slope stability analysis was performed to evaluate the impact that modifying the final grades and increased maximum elevation in Phase F-2 would have on factors of safety. The proposed final grades in Phase F-2 were specifically evaluated using deep and shallow rotational failure surfaces through the waste mass. Stability analyses were performed using a cross-section (Station 10+00) in the north-south direction.

Since the facility lies within a seismic impact zone, pseudo-static slope stability was also evaluated for potential earthquake loading conditions using circular failure mode, assuming an acceleration factor of $a = 0.30g$. The results of slope stability modeling are included in **Appendix C**.

3.2.1 Method of Analysis

The slope stability analyses in this report were completed using the computer model PCSTABL5M developed by Purdue University. Rotational failure analysis considers the stability for a nearly circular sliding surface. PCSTABL5M allows for different stability methodologies and has a built-in search routine. We applied the Simplified Bishop method of slices to calculate the minimum factor of safety (FS).

Three different slopes were modeled under both static and seismic conditions, including:

- Total slope: simulates the critical conditions from the bottom of the current landfill to the top of the proposed expansion area.
- Large Slope: simulates a failure from the bottom to the top of the expansion area.
- Small Slope: simulates a failure from the bottom of the expansion to the middle and top of the expansion area.

3.2.2 Soil and Landfill Geotechnical Parameters

The foundation soil, C&D waste, and final cover soil unit weights and shear strength parameters used in the stability analysis were selected based on various sources, including previous geotechnical reports and engineering judgement.

Based on prior reports, we estimated that bedrock is located about 10 feet below the landfill foundation soil and continuous throughout the entire cross section. Above the bedrock is a silty clay loam foundation cushion layer with a wet unit weight of 120 pounds per cubic foot. The waste properties were taken from a previous geotechnical report, prepared by Quantum Environmental & Engineering Services in March 2005. The properties for the cover soil are based on engineering experience and considering site-specific soils.

As noted above, our stability models considered a total slope failure extending from bottom of the current landfill to top of the proposed expansion, a failure from the bottom to the toe of the expansion area, as well as a failure within the expansion area only. All of the models were run for both static and seismic conditions. According to generally accepted industry standards, a minimum FS of 1.5 is required for static conditions, while a minimum FS of 1.0 is needed for seismic conditions. **Table 3** below summarizes the results of the model.

Table 3 – Summary of Slope Stability Analyses

Test	Factor of Safety in Static Conditions	Factor of Safety in Seismic Conditions ($\alpha = 0.30g$)	RESULTS
Total Slope Failure	1.82	1.0	OK
Expansion – Large Failure	2.21	1.05	OK
Expansion – Small Failure	2.23	1.06	OK

Material properties used in the slope stability analyses are summarized in **Table 4**.

Table 4 – Material Properties for Slope Stability Analyses

MATERIAL	SHEAR STRENGTH (friction and cohesion)		UNIT WEIGHT, γ (pcf)	UNIT WEIGHT, γ_{sat} (pcf)
	ϕ (deg.)	C (psf)		
Final Cover Soil	26	200	115	115
C&D Waste	35	0	63	63
Foundation Soil	33	200	120	120
Bedrock	45	200	155	155

The g-factor used for seismic loading was determined by the 2014 USGS Seismic Hazards Map. According to the map, a g-factor range of 0.30 was used for all seismic modeling.

3.2.3 Results

Overall, the results summarized above indicate that the FS under static and seismic conditions for the three scenarios modeled exceed the respective minimum acceptable FS.

3.3 SOIL REQUIREMENTS

Currently available on-site soils for operational needs (bi-monthly and intermediate cover) are very limited. Currently it is estimated that less than 5,000 cubic yards (CY) are present on site. Frequently, the site receives off site soils from local contractors, sometimes at no cost to the landfill. Assuming the working face is approximately 10,000 square feet, approximately 185 CY is needed every 14 days; or about 400 CY/month; or 5,000 CY/year.

It is estimated the landfill will reach capacity in June 2020. Therefore, the life-of-site (January 2018 through June 2020) volume of soil needed for bi-monthly and intermediate cover is about 12,000 CY. The cost of soil varies from free to \$5.00/CY including transportation. The life-of-site cost for operational soil ranges from \$0 to \$60,000.

4.0 CLOSURE AND POST CLOSURE PLAN

4.1 CLOSURE PLAN

4.1.1 Facility Description

The Yarnell Road Demolition Landfill is a permitted Class III landfill that is owned and operated by Waste Corporation of Tennessee, LLC (WCT). The landfill consists of four phases, designated F-1, F-2, F-3 and F-4. TDEC approved the closure of Phases F-1 and F-3 on March 11, 2016. Phase F-4 was capped in mid-2017 and the closure certification report was approved by TDEC on September 18, 2017. Once vegetation is established and a final inspection by TDEC, Phase F-4 will also be certified as closed.

Site closure and post-closure activities shall be conducted by WCT. WCT anticipates that the site will remain occupied and continue to be used for hauling operations following the closure of Phase F-2.

4.1.2 Closure Schedule

As previously stated, Phases F-1, F-3, and F-4 are closed. As stated in Section 2.3, it is anticipated that Phase F-2 will reach capacity in June 2020.

The owner shall notify TDEC/DSWM of the intent to close any portion of the landfill at least 60 days prior initiating closure activities. The owner shall complete closure activities including grading and establishing vegetation cover within 180 days.

Compacted final cover material shall be placed within 90 days over areas that have reached final grade. The top 12 inches must be able to support a vegetative cover. The final cover system shall consist of 18 inches of low permeability layer overlain by a 12-inch thick vegetative layer.

4.1.3 Placement of Final Cover

Final cover has been placed over Phases F-1, F-3, and F-4 and all three phases are closed.

Phase F-2 shall be covered with a 2.5 ft thick soil cap consisting of 18 inches of low permeability soil cover and 12 inches of vegetative soil cover. The 18-inch thick layer shall be compacted to achieve a hydraulic conductivity of 1×10^{-6} cm/sec or less. The low permeability layer shall be placed in lifts between 6 inches to 9 inches loose measure. Placement shall be monitored in accordance with the site's QA/QC Plan. The 12-inch thick layer of vegetative soil shall be capable of supporting a vegetative cover.

It is anticipated that approximately 36,900 cubic yards of soil will be needed to construct the final cover over Phase F-2. The closure of Phase F-2 shall be certified by a professional engineer registered in the State of Tennessee. Once closure is completed, a certification report prepared by a registered professional engineer shall be submitted to TDEC. The certification report must state the closure of Phase F-2 was in accordance with this closure plan. Any survey performed to confirm the final cap thickness will be performed by a surveyor licensed in the State of Tennessee.

4.1.4 Stormwater Management

Stormwater management controls are already installed in Phases F-1, F-3, and F-4. The proposed stormwater management controls for Phase F-2 are described in Section 3.1 of this modification and illustrated on the drawings provided in **Appendix A**.

4.1.5 Vegetation

A vegetative cover shall be established as soon as practical following the placement and grading of the final cover system. The site may need to conduct laboratory analysis to establish the approximate application rate for lime and fertilizer. Typical application rates for seeding are summarized below:

Table 5
Ground Cover Seeding, Rate/Acre

Species	Spring (Feb 15 – May 15)	Summer (May 15 – Aug 1)	Fall (Aug 1 – Oct 15)	Winter (Oct 15 – Feb 15)
KY 31 Tall Fescue	15 lbs	20 lbs	15 lbs	40 lbs
Orchard Grass	15 lbs	20 lbs	15 lbs	-
Annual Rye Grass	8 lbs	-	-	-
Winter Wheat	-	-	60 lbs	65 lbs
Buckwheat	40 lbs	-	-	-
Sudan Grass	-	10 lbs	-	-
Red Clover	8 lbs	10 lbs	8 lbs	10 lbs
Crimson Clover	-	20 lbs	15 lbs	
Korean Lespedeza	-	-	-	10 lbs

4.1.6 Leachate Management

The leachate management system for the landfill is currently constructed and operational. A network of leachate collection pipes (see Drawing 2) collects and conveys leachate to an above ground storage tank. Leachate is treated and discharged into the West Knox Sewer District sewer line.

No additional leachate management components or modifications are anticipated at this time.

4.1.7 Landfill Gas Management

Passive landfill gas vents are currently installed in Phases F-1, F-3, and F-4. A passive landfill gas venting system is planned as part of the closure activities for Phase F-2. Passive vents will

be installed at a frequency of one per acre as shown in the permit drawings. A detail of the passive vent is shown in the permit drawings.

4.2 POST CLOSURE PLAN

4.2.1 Post Closure Activities

In accordance with Rule 0400-11-01.04, Section 8(d), the operator must perform the following activities on closed portions of the facility for a 2-year period following closure.

- Maintain the final cover closure grades and stormwater control structures, such as, channels, sediment basins, and culverts.
- Maintain a healthy vegetative cover on the landfill surface to minimize erosion.
- Maintain, monitor, and inspect the leachate collection and removal system, including the treatment system, storage tank, discharge pumps and discharge force main.
- Maintain and inspect the landfill gas vents installed on the final cover.
- Maintain and monitor the groundwater monitoring wells.

Following completion of the post closure care period, the owner must file with TDEC a certification verifying that post closure has been completed in accordance with the post closure plan.

The operator shall ensure that, within 90 days of completion of final closure of the facility and prior to sale or lease of the property on which the facility is located, there is recorded, in accordance with Tennessee State Law, a notation on the deed to the property or on some other instrument which is normally examined during title search that the land has been used as a disposal facility and its use is restricted in accordance with the approved closure/post closure plan.

4.3 CLOSURE AND POST CLOSURE COST ESTIMATES

As previously stated, Phases F-1, F-3, and F-4 are closed and the only remaining landfill phase yet to be closed in Phase F-2. An itemized closure cost estimate for closing Phase F-2 is provided in **Appendix D**.

Phase F-1 and Phase F-3 were deemed closed on March 11, 2016. At that time, the 2-year post closure period began. Since these units already completed their post-closure period, revised post closure cost estimates were only prepared for Phases F-2 and F-4. An itemized post closure care costs estimate is provided in **Appendix D**.

APPENDICES

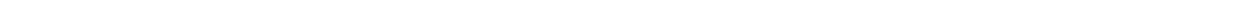

APPENDIX A

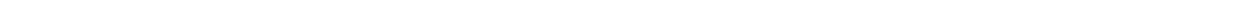

MAJOR PERMIT MODIFICATION - PHASE F-2

YARNELL ROAD DEMOLITION LANDFILL

(DML-47-0069)

WASTE CORPORATION OF TENNESSEE, LLC
YARNELL ROAD DEMOLITION LANDFILL
1550 LAMONS QUARRY LANE
KNOXVILLE, TENNESSEE 37932

SCS ENGINEERS
2520 WHITEHALL PARK DRIVE, SUITE 450
CHARLOTTE, NORTH CAROLINA 28273
(704) 504-3107

JOB NO. 02217306.02

MARCH 2018
REV. JUNE 2018
REV. OCTOBER 2018

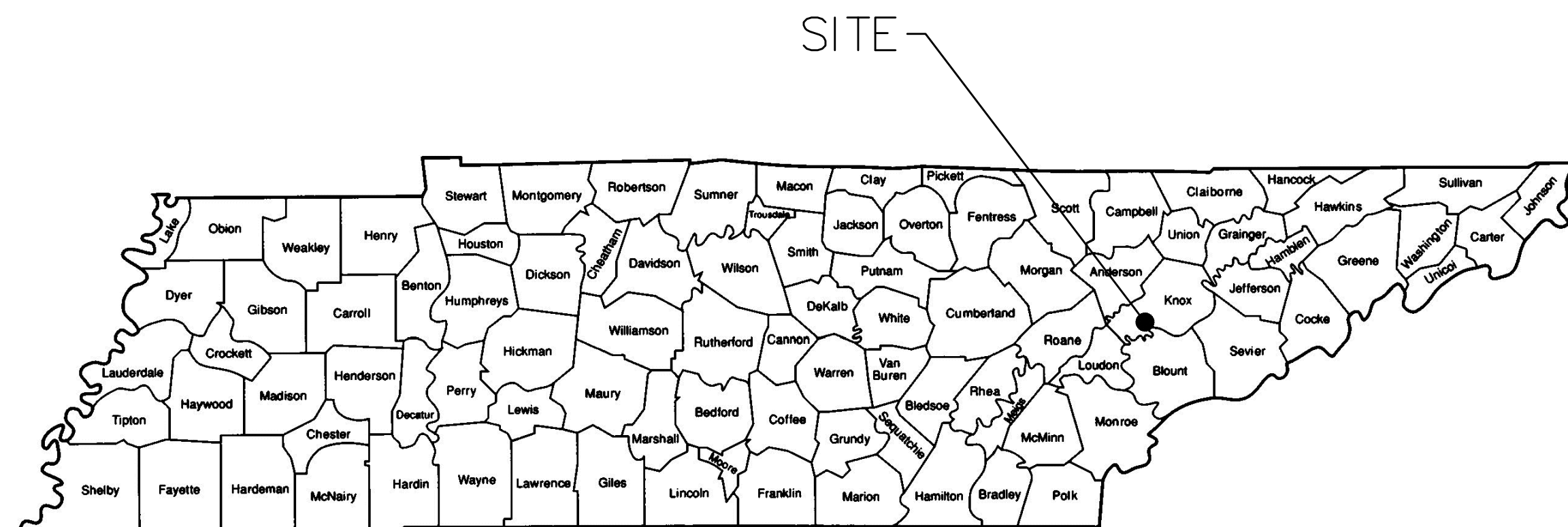

AREA MAP
SCALE: NTS

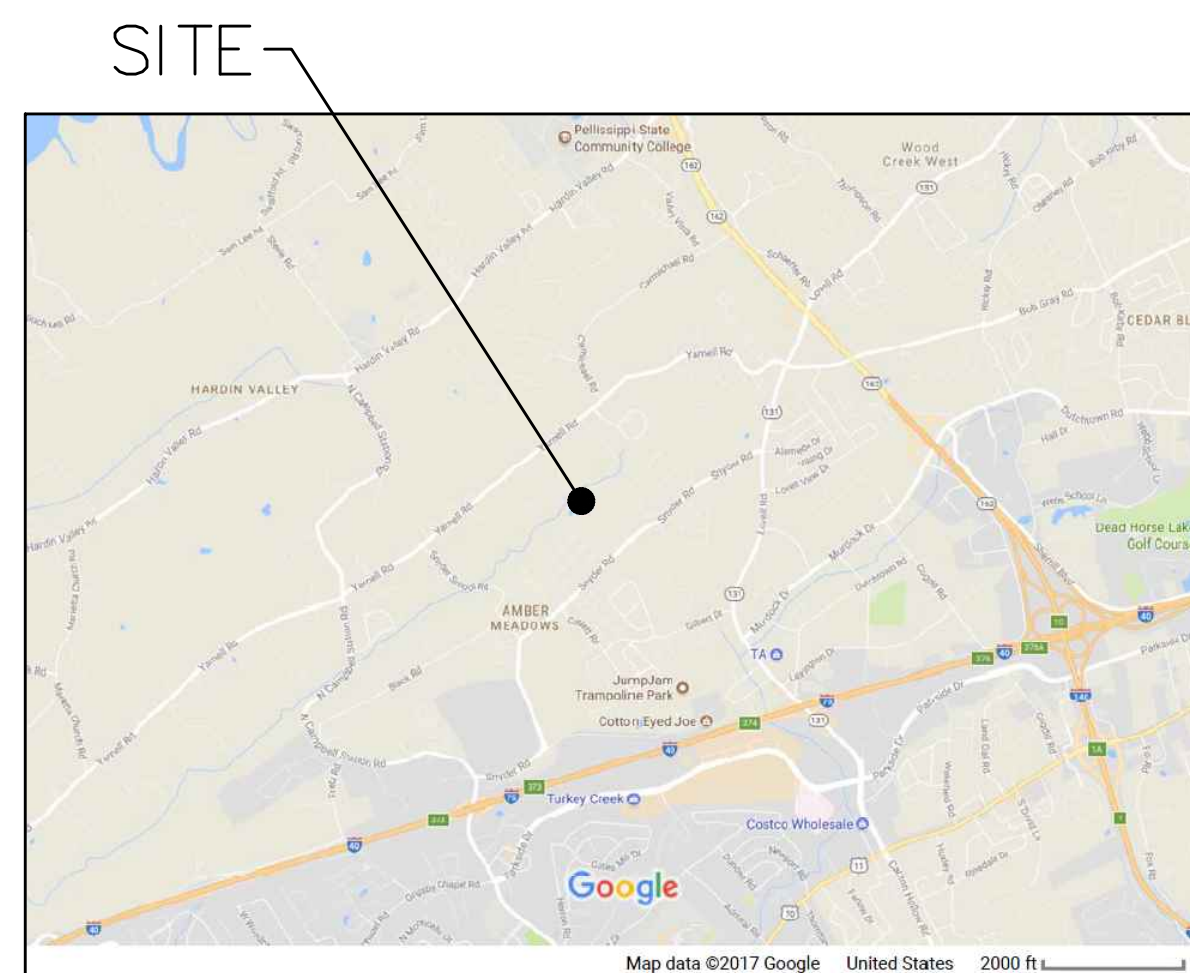

LOCATION MAP
SCALE: AS SHOWN

INDEX OF SHEETS	
SHEET NO.	DESCRIPTION
1	TITLE SHEET
2	EXISTING CONDITIONS
3	PHASE F-2 EXISTING CONDITIONS
4	PHASE F-2 FINAL GRADING PLAN
5	STORMWATER AND EC PLAN
6A	EAST 7+00 SECTION VIEW
6B	EAST 9+00 SECTION VIEW
6C	EAST 11+00 SECTION VIEW
6D	EAST 13+00 SECTION VIEW
7A	NORTH 3+00 SECTION VIEW
7B	NORTH 3+00 SECTION VIEW
8	DETAILS 1
9	DETAILS 2
10	DETAILS 3
11	DETAILS 4
12	DOWN CHUTE PROFILES

EXPLANATION OF "SECTION" OR "DETAIL" SYMBOL

"SECTION" OR "DETAIL" IDENTIFICATION NUMBER OR LETTER.

SHEET NUMBER ON WHICH "SECTION" OR "DETAIL" IS REFERENCED. MAY BE MORE THAN ONE SHEET

SHEET NUMBER ON WHICH "SECTION" OR "DETAIL" IS DRAWN

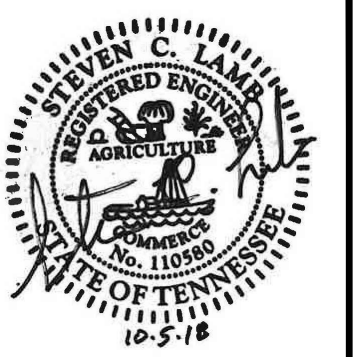
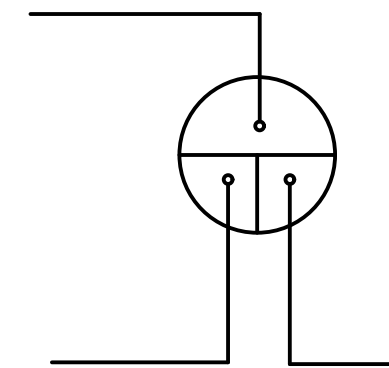

NO.	REVISION	DATE
1	REVISED PER IDEC COMMENTS	6/8/18
2	REVISED PER IDEC COMMENTS	9/21/18

SHEET TITLE	PROJECT TITLE
TITLE SHEET	WCA YARNELL ROAD LANDFILL MAJOR PERMIT MODIFICATION

CLIENT
WASTE CORPORATION OF TENNESSEE, LLC 1550 LAMONS QUARRY LANE KNOXVILLE, TENNESSEE 37932

SCS ENGINEERS 2520 WHITEHALL PARK DRIVE, SUITE 450 CHARLOTTE, NORTH CAROLINA 28273 PHONE: (704) 504-3107 FAX: (704) 504-3174	OWN. BY: JCT JOB NO: 02217306.02 DATE: 9/21/18 SCALE: SCL
--	--

CADD FILE: SHT01-TITLE...
DATE: SEPTEMBER 2018
SCALE: AS SHOWN
DRAWING NO.

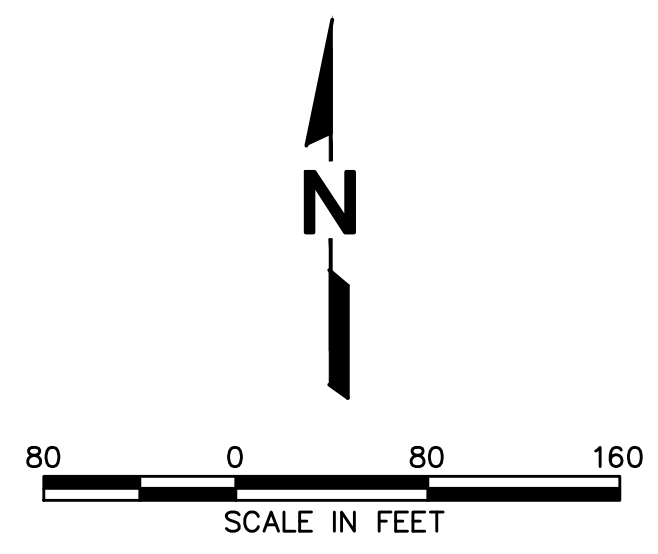
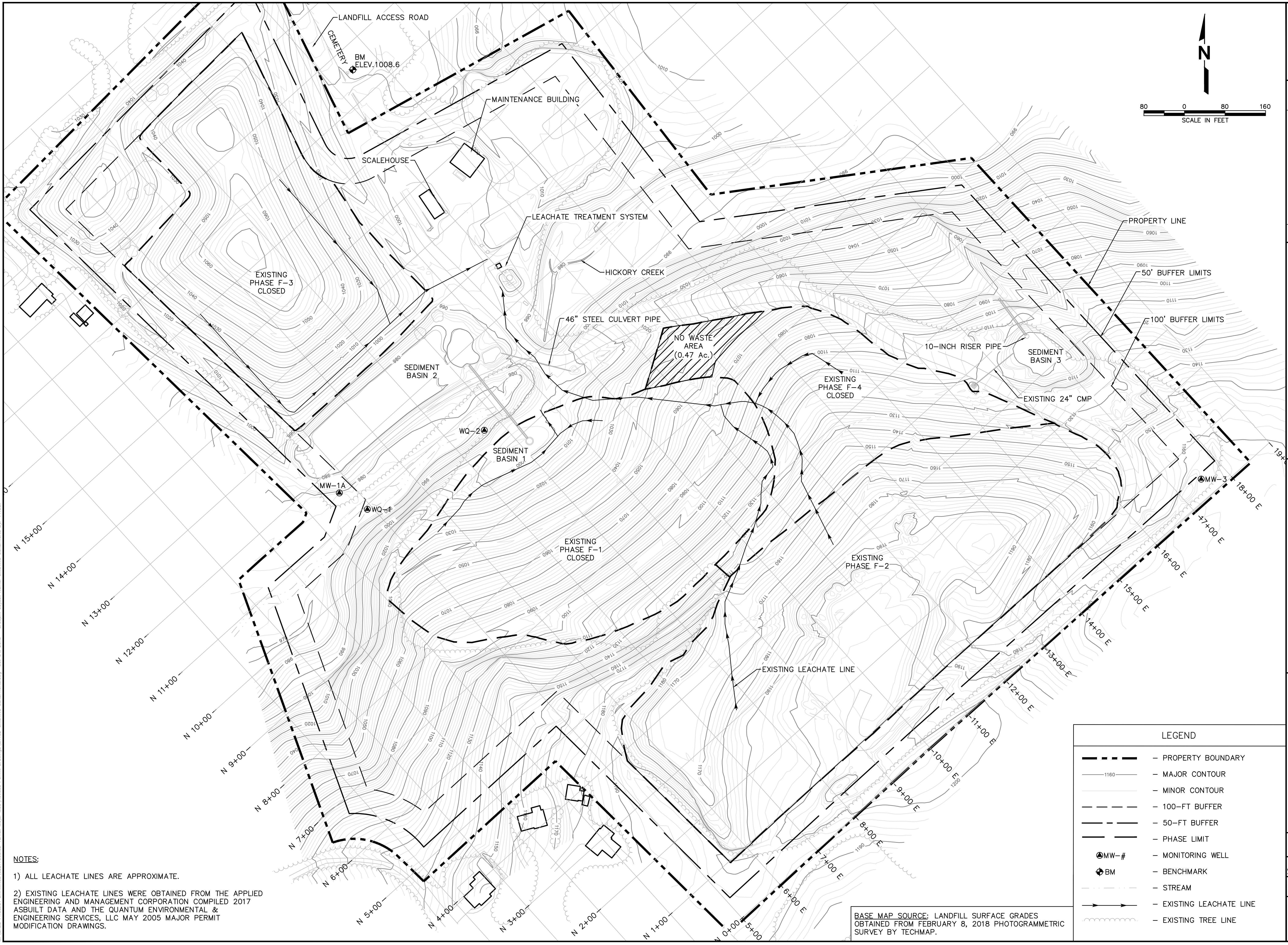

DATE	6/8/18
REVISION	REVISED PER IDEC COMMENTS
NO.	9/21/18
	REVISED PER IDEC COMMENTS

SHEET TITLE: **EXISTING CONDITIONS**
 PROJECT TITLE: **WCA YARNELL ROAD LANDFILL MAJOR PERMIT MODIFICATION**

CLIENT: **WASTE CORPORATION OF TENNESSEE, LLC**
 1550 LAMONS QUARRY LANE
 KNOXVILLE, TENNESSEE 37932

SCS ENGINEERS
 2520 WHITEHALL PARK DRIVE, SUITE 450
 CHARLOTTE, NORTH CAROLINA 28273
 PHONE: (704) 504-3107 FAX: (704) 504-3174
 PROJ. BY: [unreadable] JCT: [unreadable]
 DWG. BY: [unreadable] CHK. BY: [unreadable] APP. BY: [unreadable] SCL: [unreadable]

CADD FILE: SHT02-EXIST...
 DATE: SEPTEMBER 2018
 SCALE: AS SHOWN
 DRAWING NO. **2** of 12

NOTES:
 1) ALL LEACHATE LINES ARE APPROXIMATE.
 2) EXISTING LEACHATE LINES WERE OBTAINED FROM THE APPLIED ENGINEERING AND MANAGEMENT CORPORATION COMPILED 2017 ASBULT DATA AND THE QUANTUM ENVIRONMENTAL & ENGINEERING SERVICES, LLC MAY 2005 MAJOR PERMIT MODIFICATION DRAWINGS.

BASE MAP SOURCE: LANDFILL SURFACE GRADES OBTAINED FROM FEBRUARY 8, 2018 PHOTOGRAMMETRIC SURVEY BY TECHMAP.

LEGEND	
	PROPERTY BOUNDARY
	MAJOR CONTOUR
	MINOR CONTOUR
	100-FT BUFFER
	50-FT BUFFER
	PHASE LIMIT
	MW-# - MONITORING WELL
	BM - BENCHMARK
	STREAM
	EXISTING LEACHATE LINE
	EXISTING TREE LINE

LEGEND

- 850 — - 10 FOOT MAJOR CONTOUR
- — - MINOR CONTOUR
- - - - - PROPERTY BOUNDARY
- - - - - 100-FT BUFFER
- - - - - 50-FT BUFFER
- - - - - PHASE LIMIT
- - - - - UNPAVED ROADWAY
- - - - - EXISTING CULVERT PIPE
- ☒ - EXISTING CATCH BASIN
- ⊙MW-# - MONITORING WELL
- ~~~~~ - EXISTING TREE LINE

BASE MAP SOURCE: LANDFILL SURFACE GRADES OBTAINED FROM FEBRUARY 8, 2018 PHOTOGRAMMETRIC SURVEY BY TECHMAP.

NOTES:

- 1) ALL LEACHATE LINES ARE APPROXIMATE.



NO.	REVISION	DATE
1	REVISED PER TDEC COMMENTS	6/8/18
2	REVISED PER TDEC COMMENTS	9/21/18

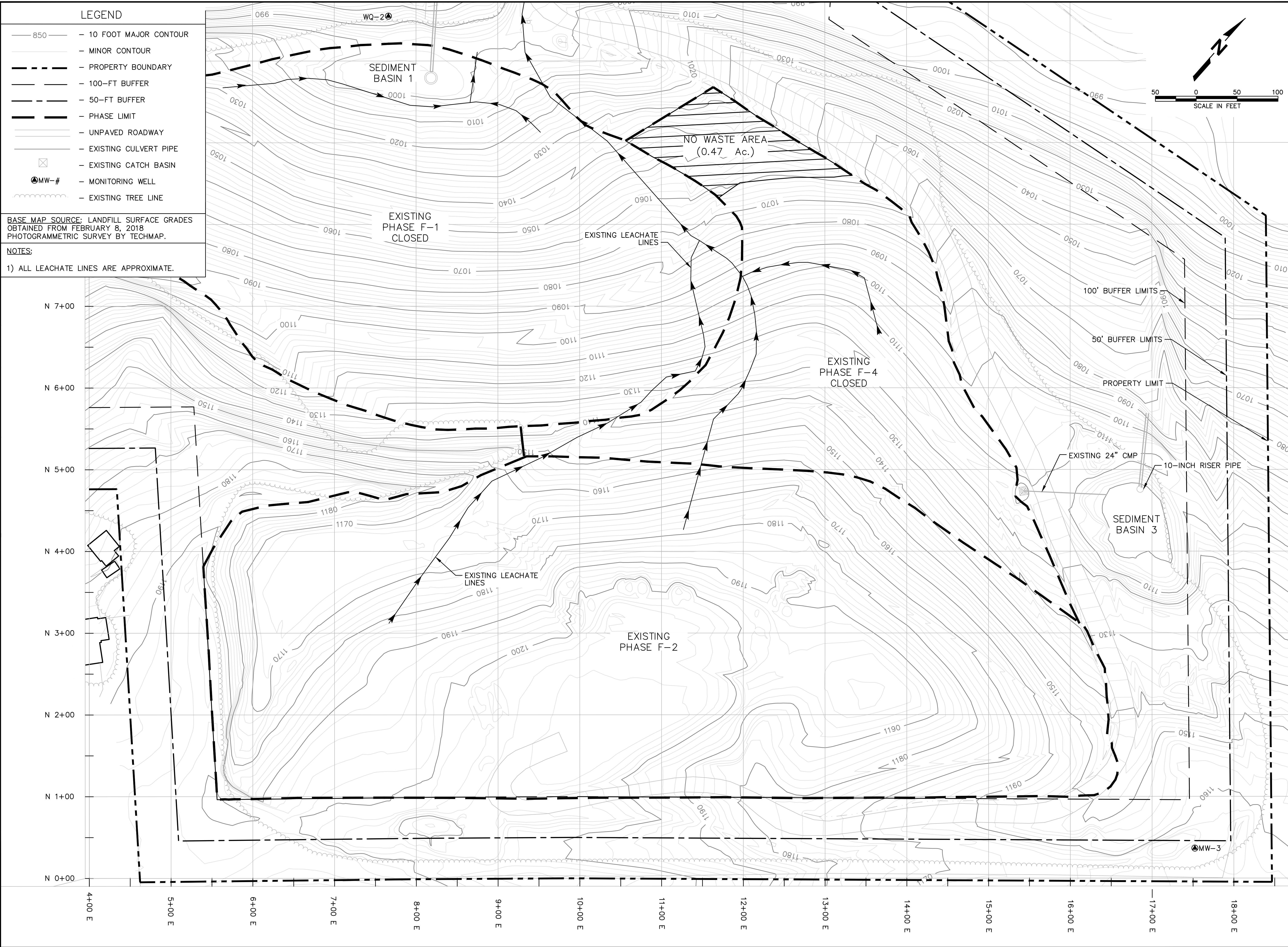
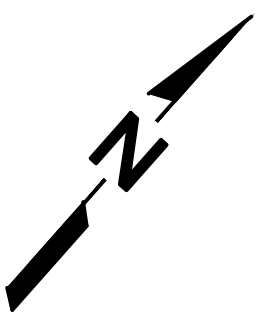

SHEET TITLE
PHASE F-2 EXISTING CONDITIONS

PROJECT TITLE
WCA YARNELL ROAD LANDFILL MAJOR PERMIT MODIFICATION

CLIENT

WASTE CORPORATION OF TENNESSEE, LLC
1550 LAMONS QUARRY LANE
KNOXVILLE, TENNESSEE 37932

SCS ENGINEERS
2520 WHITEHALL PARK DRIVE, SUITE 450
CHARLOTTE, NORTH CAROLINA 28273
PHONE: (704) 504-3107 FAX: (704) 504-3174

DESIGNER: SCL
DRAWN BY: SCL
CHECKED BY: SCL
DATE: 02/27/2018
SCALE: AS SHOWN

CADD FILE:
SHT03-PHASE...

DATE:
SEPTEMBER 2018

SCALE:
AS SHOWN

DRAWING NO.

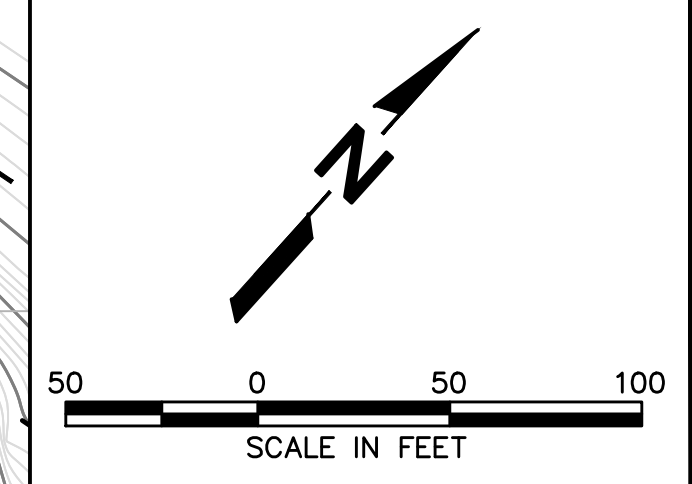
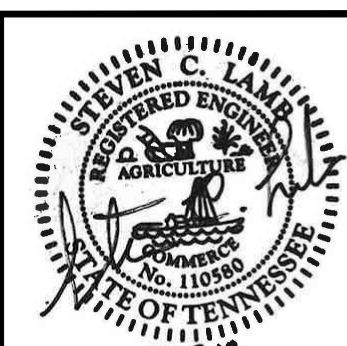

NO.	REVISION	DATE
1	REVISED PER TDEC COMMENTS	6/8/18
2	REVISED PER TDEC COMMENTS	9/21/18

SHEET TITLE
PHASE F-2 FINAL GRADING PLAN

PROJECT TITLE
WCA YARNELL ROAD LANDFILL
MAJOR PERMIT MODIFICATION

CLIENT
WASTE CORPORATION
OF TENNESSEE, LLC
1550 LAMONS QUARRY LANE
KNOXVILLE, TENNESSEE 37932

SCS ENGINEERS
2520 WHITEHALL PARK DRIVE, SUITE 450
CHARLOTTE, NORTH CAROLINA 28273
PHONE: (704) 504-3107 FAX: (704) 504-3174

PROJ. NO. 1802217306.02
DATE: 9/21/18
DRAWN BY: JCT
CHECKED BY: SCL
APP. BY: SCL

CADD FILE: SHT04-FINAL...

DATE: SEPTEMBER 2018

SCALE: AS SHOWN

DRAWING NO.

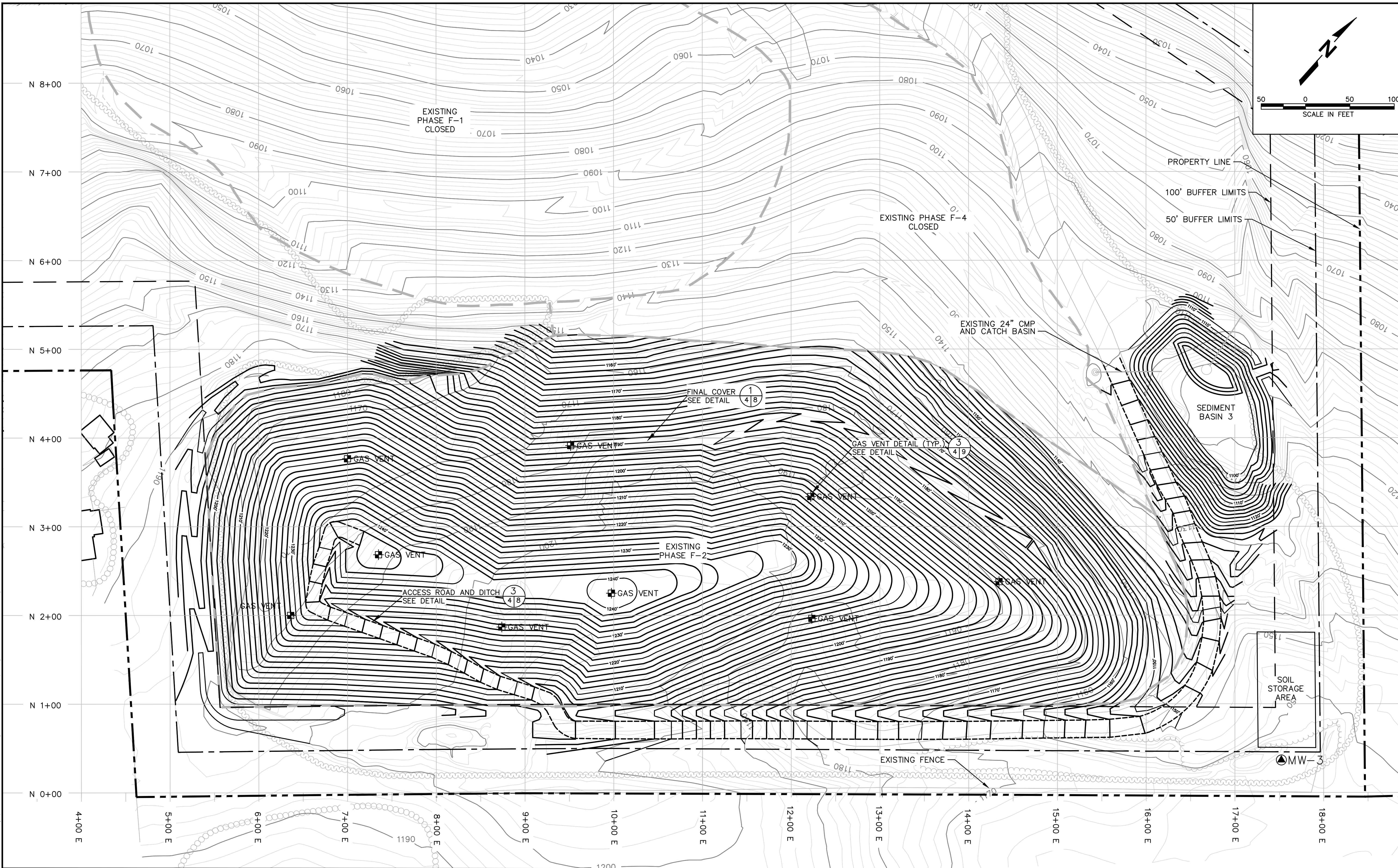

LEGEND	
	- 10 FOOT MAJOR CONTOUR (PROPOSED)
	- MINOR CONTOUR (PROPOSED)
	- 10 FOOT MAJOR CONTOUR (EXISTING)
	- MINOR CONTOUR (EXISTING)
	- PHASE BOUNDARY
	- EXISTING CATCH BASIN
	- PROPERTY BOUNDARY
	- 100-FT BUFFER
	- 50-FT BUFFER
	- MONITORING WELL
	- PROPOSED ROAD
	- PROPOSED GAS VENT
	- EXISTING TREE LINE

- NOTES**
- FOR TYPICAL FINAL COVER DETAIL SEE DETAIL 1, SHEET 8.
 - PROPOSED CONTOURS WITHIN PHASE F-2 REPRESENT TOP OF FINAL COVER.
 - FOR THE SLOPE STABILITY ANALYSIS, SECTION 10+00 E WAS SELECTED AS THE CRITICAL CROSS-SECTION AS IT REACHES THE HIGHEST ELEVATION AT EL 1240, NEAR THE MAXIMUM ELEVATION, AND REPRESENTS THE LONGEST SLOPE AT APPROXIMATELY 280 FEET FROM CREST TO TOE AT 3:1 SLOPE.

BASE MAP SOURCE: LANDFILL SURFACE GRADES OBTAINED FROM FEBRUARY 8, 2018 PHOTOGRAMMETRIC SURVEY BY TECHMAP.

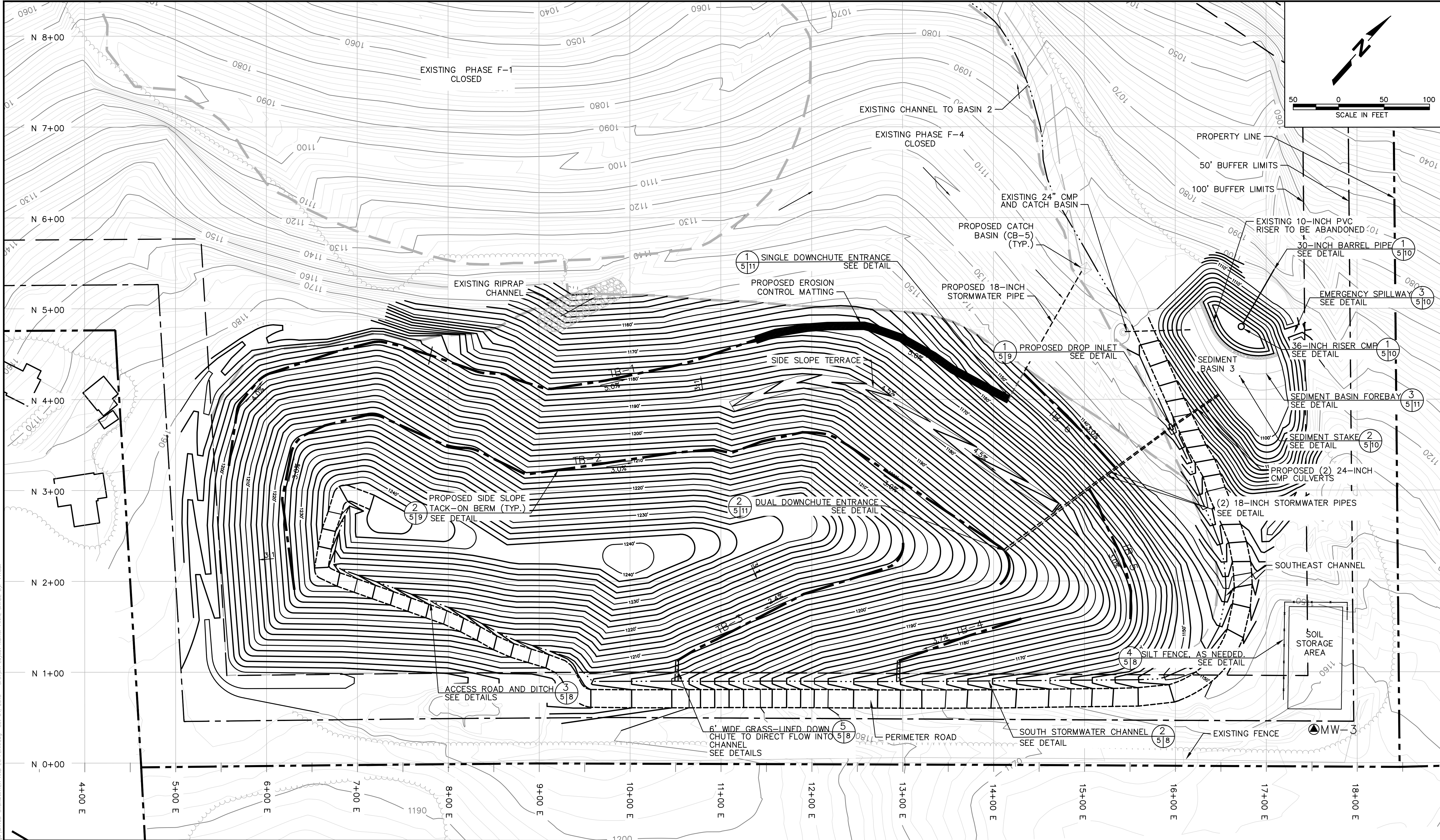

NO.	REVISION	DATE
1	REVISED PER TDEC COMMENTS	6/28/18
2	REVISED PER TDEC COMMENTS	9/21/18

STORMWATER MANAGEMENT PLAN
WCA YARNELL ROAD LANDFILL MAJOR PERMIT MODIFICATION

CLIENT
WASTE CORPORATION OF TENNESSEE, LLC
 1550 LAMONS QUARRY LANE
 KNOXVILLE, TENNESSEE 37932

SCS ENGINEERS
 2520 WHITEHALL PARK DRIVE, SUITE 450
 CHARLOTTE, NORTH CAROLINA 28273
 PHONE: (704) 504-3107 FAX: (704) 504-3174

CADD FILE: SHT05-STORM...
 DATE: SEPTEMBER 2018
 SCALE: AS SHOWN
 DRAWING NO.

LEGEND	
	10 FOOT MAJOR CONTOUR (PROPOSED)
	MINOR CONTOUR (PROPOSED)
	10 FOOT MAJOR CONTOUR (EXISTING)
	MINOR CONTOUR (EXISTING)
	PHASE BOUNDARY
	EXISTING CATCH BASIN
	SIDE SLOPE TACK ON BERM
	PROPERTY BOUNDARY
	100-FT BUFFER
	50-FT BUFFER
	MONITORING WELL
	PROPOSED ROAD
	EXISTING TREE LINE

NOTES

- REFER TO APPENDIX B OF THE PERMIT APPLICATION FOR STORMWATER CALCULATIONS.
- EROSION CONTROL MATTING IS NEEDED FOR THE LAST 300 FEET OF TACK-ON BERM 1, ACCESS ROAD DITCH, SOUTH CHANNEL AND SOUTHEAST CHANNEL.
- THE EROSION CONTROL MATTING SHALL BE NORTH AMERICAN GREEN - ERONET P300 EROSION CONTROL BLACKET OR ENGINEER APPROVED EQUAL.

BASE MAP SOURCE: LANDFILL SURFACE GRADES OBTAINED FROM FEBRUARY 8, 2018 PHOTOGRAMMETRIC SURVEY BY TECHMAP.



NO.	REVISION	DATE
1	REVISED PER TDEC COMMENTS	6/8/18
2	REVISED PER TDEC COMMENTS	9/21/18
3		
4		
5		

SHEET TITLE
EAST 7+00 SECTION VIEW

PROJECT TITLE
**WCA YARNELL ROAD LANDFILL
MAJOR PERMIT MODIFICATION**

CLIENT
**WASTE CORPORATION
OF TENNESSEE, LLC**
1550 LAMONS QUARRY LANE
KNOXVILLE, TENNESSEE 37932

SCS ENGINEERS
2520 WHITEHALL PARK DRIVE, SUITE 450
CHARLOTTE, NORTH CAROLINA 28273
PHONE: (704) 504-3107 FAX: (704) 504-3174

PROJ. NO. 02217306.02
DATE: 02/21/2018
SCALE: SCL

DRAWN BY: JCT
CHECKED BY: OJH
SCALE: SCL

DATE: SEPTEMBER 2018
SCALE: AS SHOWN
DRAWING NO. **6A** of 12

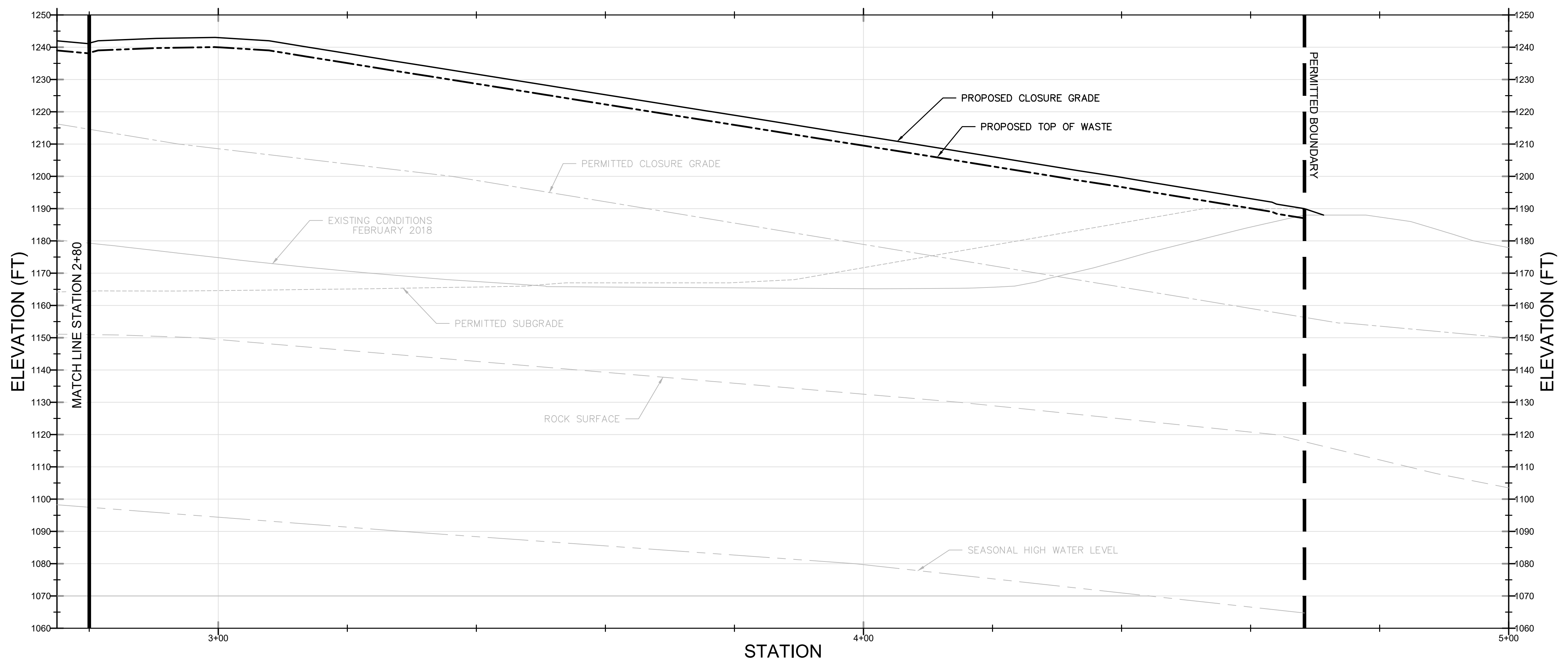
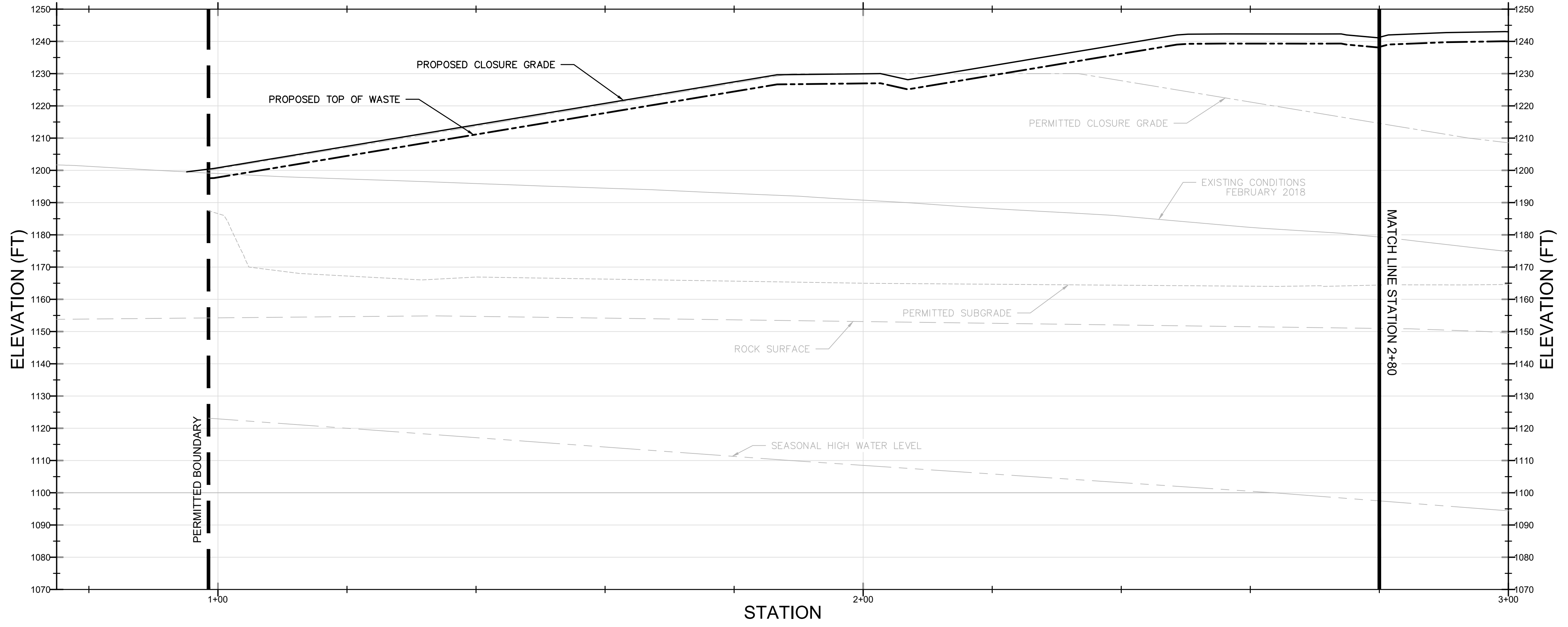

HORIZONTAL SCALE: 1" = 10'
VERTICAL SCALE: 1" = 20'

SECTION E 7+00

LEGEND

	- PROPOSED CLOSURE GRADE		- TOP OF WASTE
	- PERMITTED SUBGRADE		- ROCK SURFACE
	- PERMITTED CLOSURE GRADE 2006		- EXISTING CONDITIONS
	- PERMITTED PHASE F-2 BOUNDARY		- APPROX. SEASONAL HIGH WATER LEVEL

- SOURCE NOTES:
1. PERMITTED SUBGRADE GRADES FROM MAY 2017, CREATED FROM DRONE SURVEY PROVIDED BY APPLIED ENGINEERING & MANAGEMENT CORPORATION OR 2006 PERMIT MODIFICATION DRAWINGS PREPARED BY QUANTUM ENVIRONMENTAL AND ENGINEERING SERVICES, LLC..
 2. LANDFILL SURFACE GRADES OBTAINED FROM FEBRUARY 8, 2018 PHOTOGRAMMETRIC SURVEY BY TECHMAP.
 3. EXISTING BEDROCK SURFACES ARE APPROXIMATE AND WERE CREATED USING 2006 PERMIT MODIFICATION DRAWINGS PREPARED BY QUANTUM ENVIRONMENTAL AND ENGINEERING SERVICES, LLC.

M:\CADD PROJECT DRAWINGS\02217306.02 Yarnell Major Mod\Revised Permit Drawings\SHT06-07 - SECTION E VIEWS FINAL.dwg Oct 04, 2018 - 3:37pm Layout Name: Sheet 6A By: 4415br

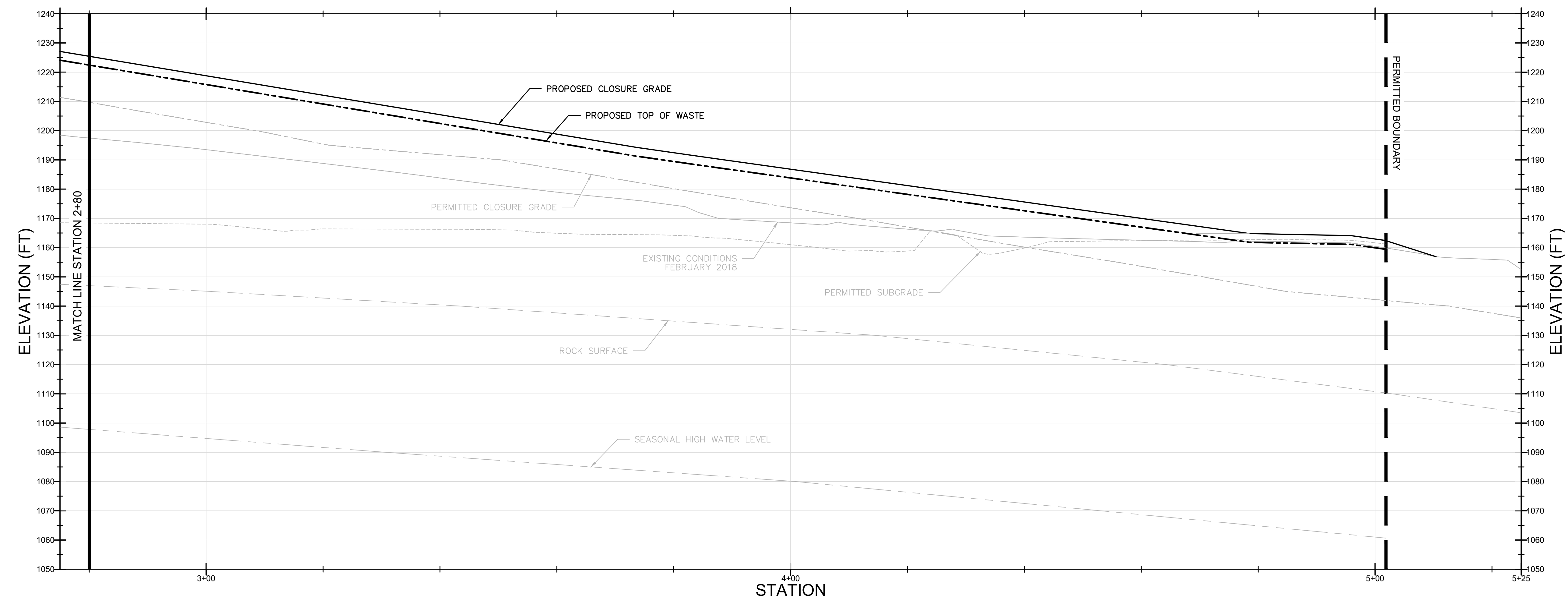
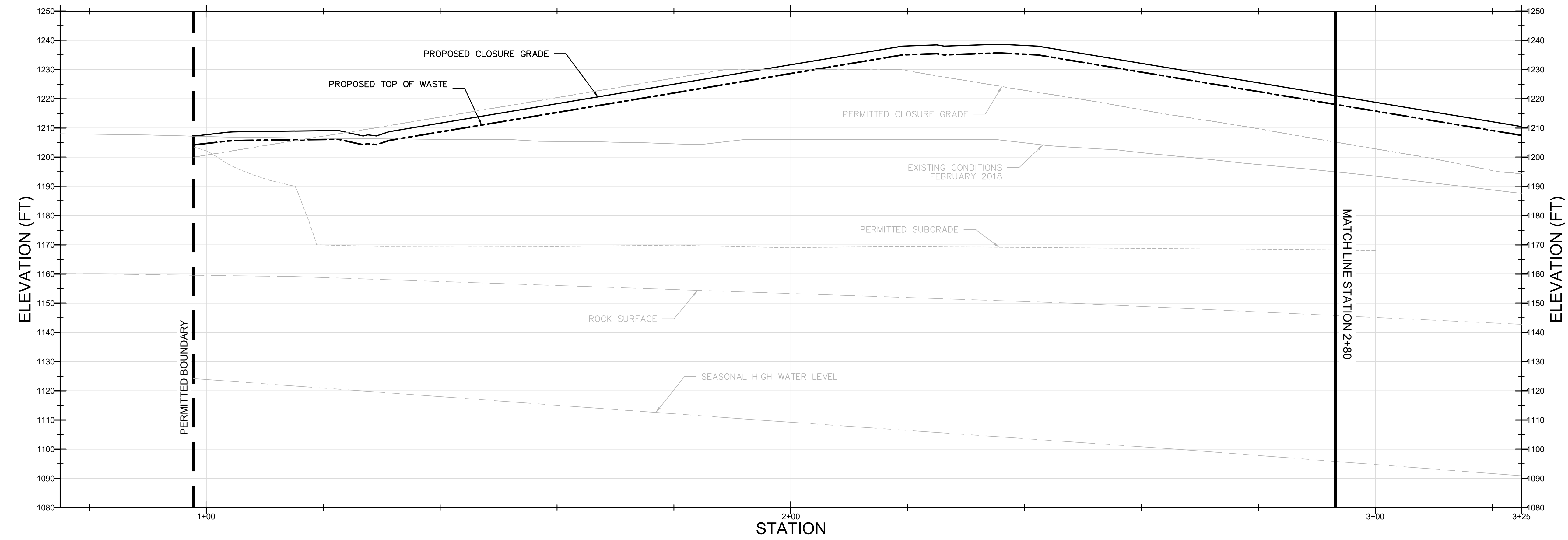

HORIZONTAL SCALE: 1" = 10'
 VERTICAL SCALE: 1" = 20'
SECTION - E 9+00

LEGEND	
	PROPOSED CLOSURE GRADE
	PERMITTED SUBGRADE
	PERMITTED CLOSURE GRADE 2006
	PERMITTED PHASE F-2 BOUNDARY
	TOP OF WASTE
	ROCK SURFACE
	EXISTING CONDITIONS
	APPROX. SEASONAL HIGH WATER LEVEL

- SOURCE NOTES:**
1. PERMITTED SUBGRADE GRADES FROM MAY 2017, CREATED FROM DRONE SURVEY PROVIDED BY APPLIED ENGINEERING & MANAGEMENT CORPORATION OR 2006 PERMIT MODIFICATION DRAWINGS PREPARED BY QUANTUM ENVIRONMENTAL AND ENGINEERING SERVICES, LLC..
 2. LANDFILL SURFACE GRADES OBTAINED FROM FEBRUARY 8, 2018 PHOTOGRAMMETRIC SURVEY BY TECHMAP.
 3. EXISTING BEDROCK SURFACES ARE APPROXIMATE AND WERE CREATED USING 2006 PERMIT MODIFICATION DRAWINGS PREPARED BY QUANTUM ENVIRONMENTAL AND ENGINEERING SERVICES, LLC.

NO.	REVISION	DATE
1	REVISED PER TDEC COMMENTS	6/8/18
2	REVISED PER TDEC COMMENTS	9/21/18

SHEET TITLE: **EAST 9+00 SECTION VIEW**
 PROJECT TITLE: **WCA YARNELL ROAD LANDFILL MAJOR PERMIT MODIFICATION**

CLIENT: **WASTE CORPORATION OF TENNESSEE, LLC**
 1550 LAMONS QUARRY LANE
 KNOXVILLE, TENNESSEE 37932

SCS ENGINEERS
 2520 WHITEHALL PARK DRIVE, SUITE 450
 CHARLOTTE, NORTH CAROLINA 28273
 PHONE: (704) 504-3107 FAX: (704) 504-3174
 PROJ. NO. 17-005-02
 DWG. BY: JCT
 CHK. BY: OJH
 APP. BY: SCL

CADD FILE: SHT06-07 SE...
 DATE: **SEPTEMBER 2018**
 SCALE: **AS SHOWN**
 DRAWING NO. **6B** of 12

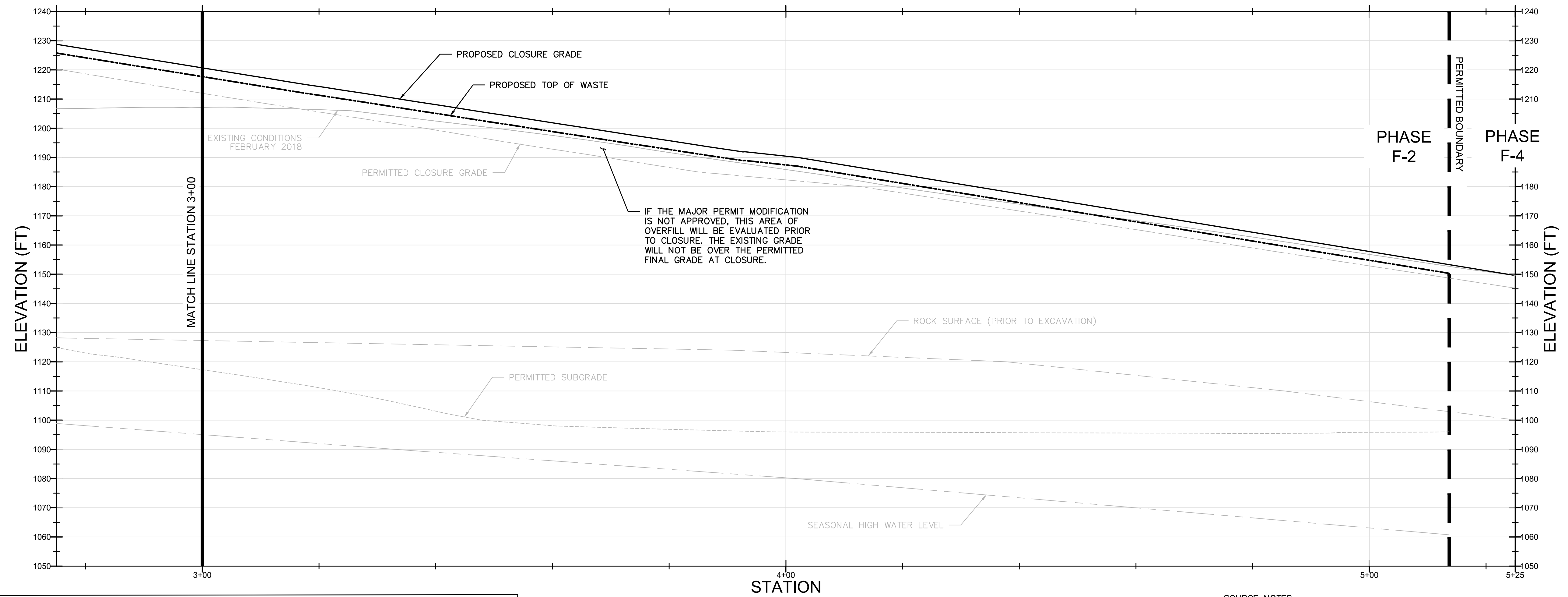
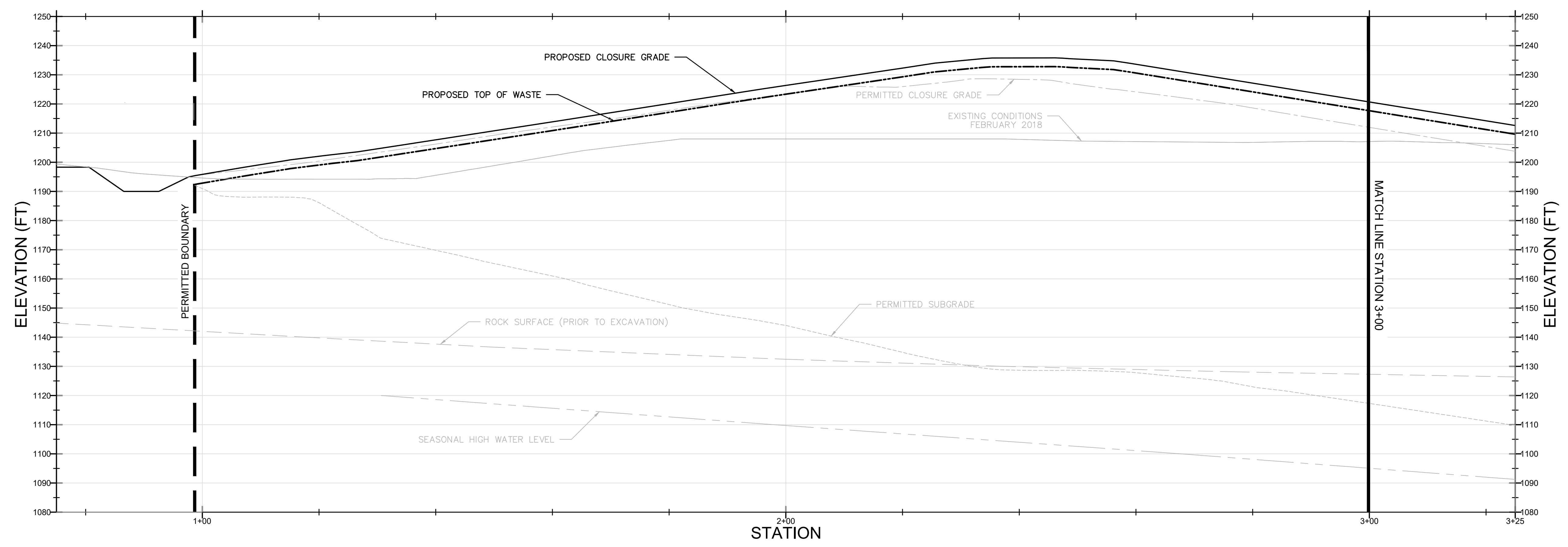

LEGEND			
—————	— PROPOSED CLOSURE GRADE	-----	— TOP OF WASTE
-----	— PERMITTED SUBGRADE	-----	— ROCK SURFACE
-----	— PERMITTED CLOSURE GRADE 2006	-----	— EXISTING CONDITIONS
-----	— PERMITTED PHASE F-2 BOUNDARY	-----	— APPROX. SEASONAL HIGH WATER LEVEL

HORIZONTAL SCALE: 1" = 10'
 VERTICAL SCALE: 1" = 20'
SECTION - E 11+00

SOURCE NOTES:

1. PERMITTED SUBGRADE GRADES FROM MAY 2017, CREATED FROM DRONE SURVEY PROVIDED BY APPLIED ENGINEERING & MANAGEMENT CORPORATION OR 2006 PERMIT MODIFICATION DRAWINGS PREPARED BY QUANTUM ENVIRONMENTAL AND ENGINEERING SERVICES, LLC..
2. LANDFILL SURFACE GRADES OBTAINED FROM FEBRUARY 8, 2018 PHOTOGRAMMETRIC SURVEY BY TECHMAP.
3. EXISTING BEDROCK SURFACES ARE APPROXIMATE AND WERE CREATED USING 2006 PERMIT MODIFICATION DRAWINGS PREPARED BY QUANTUM ENVIRONMENTAL AND ENGINEERING SERVICES, LLC.

NO.	REVISION	DATE
1	REVISED PER TDEC COMMENTS	6/8/18
2	REVISED PER TDEC COMMENTS	9/21/18

SHEET TITLE: **EAST 11 + 00 SECTION VIEW**
 PROJECT TITLE: **WCA YARNELL ROAD LANDFILL MAJOR PERMIT MODIFICATION**

CLIENT: **WASTE CORPORATION OF TENNESSEE, LLC**
 1550 LAMONS QUARRY LANE
 KNOXVILLE, TENNESSEE 37932

SCS ENGINEERS
 2520 WHITEHALL PARK DRIVE, SUITE 450
 CHARLOTTE, NORTH CAROLINA 28273
 PHONE: (704) 504-3107 FAX: (704) 504-3174
 PROJ. NO.: 02/27/2006.02
 DATE: 02/27/2006.02
 DWG. BY: JCT
 CHK. BY: OJH
 APP. BY: SCL

CADD FILE: SHT06-07 SE...
 DATE: **SEPTEMBER 2018**
 SCALE: **AS SHOWN**

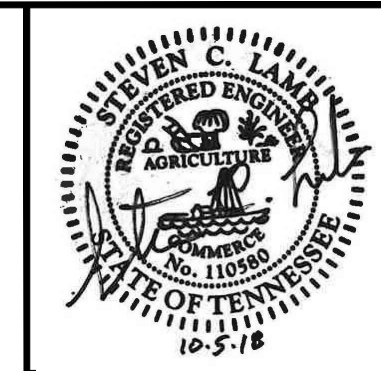

NO.	REVISION	DATE
1	REVISED PER TDEC COMMENTS	6/8/18
2	REVISED PER TDEC COMMENTS	9/21/18
3		
4		
5		

SHEET TITLE
EAST 13+00 SECTION VIEW

PROJECT TITLE
WCA YARNELL ROAD LANDFILL MAJOR PERMIT MODIFICATION

CLIENT
WASTE CORPORATION OF TENNESSEE, LLC
1550 LAMONS QUARRY LANE
KNOXVILLE, TENNESSEE 37932

SCS ENGINEERS
2520 WHITEHALL PARK DRIVE, SUITE 450
CHARLOTTE, NORTH CAROLINA 28273
PHONE: (704) 504-3107 FAX: (704) 504-3174

DATE: 02/27/2018
DWG. BY: JCT
CHK. BY: OJH
APP. BY: SCL

CADD FILE:
SHT06-07 SE...

DATE:
SEPTEMBER 2018

SCALE:
AS SHOWN

DRAWING NO.
6D of 12

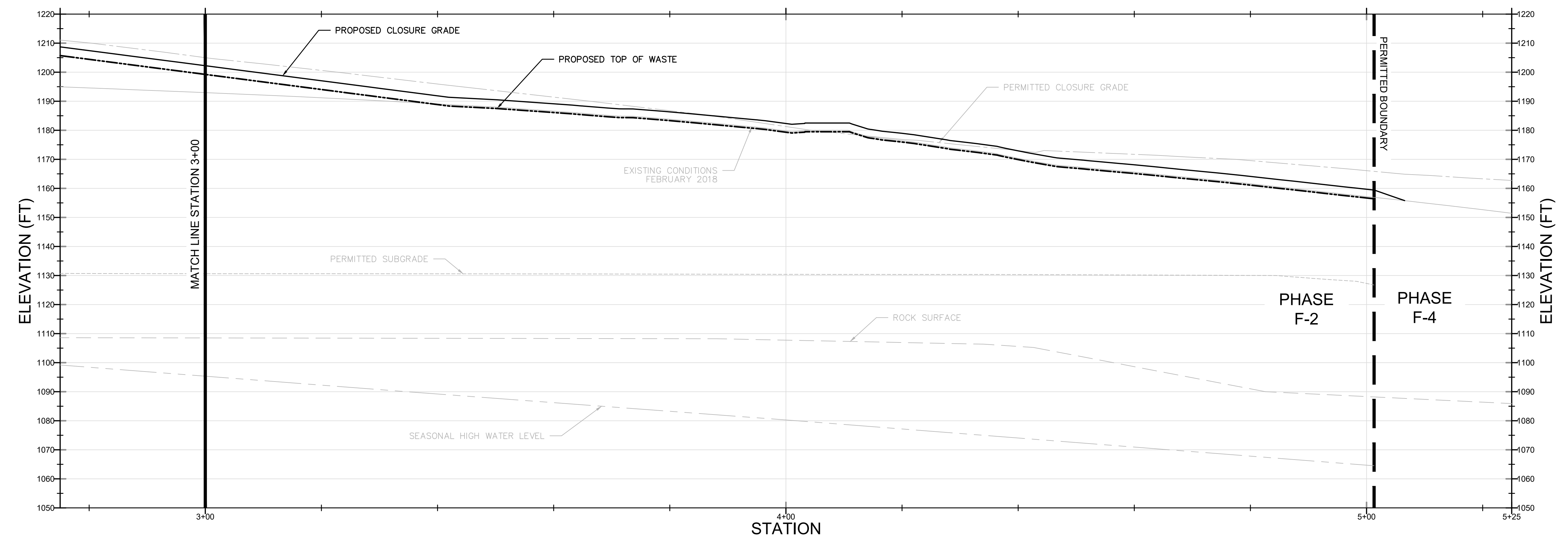
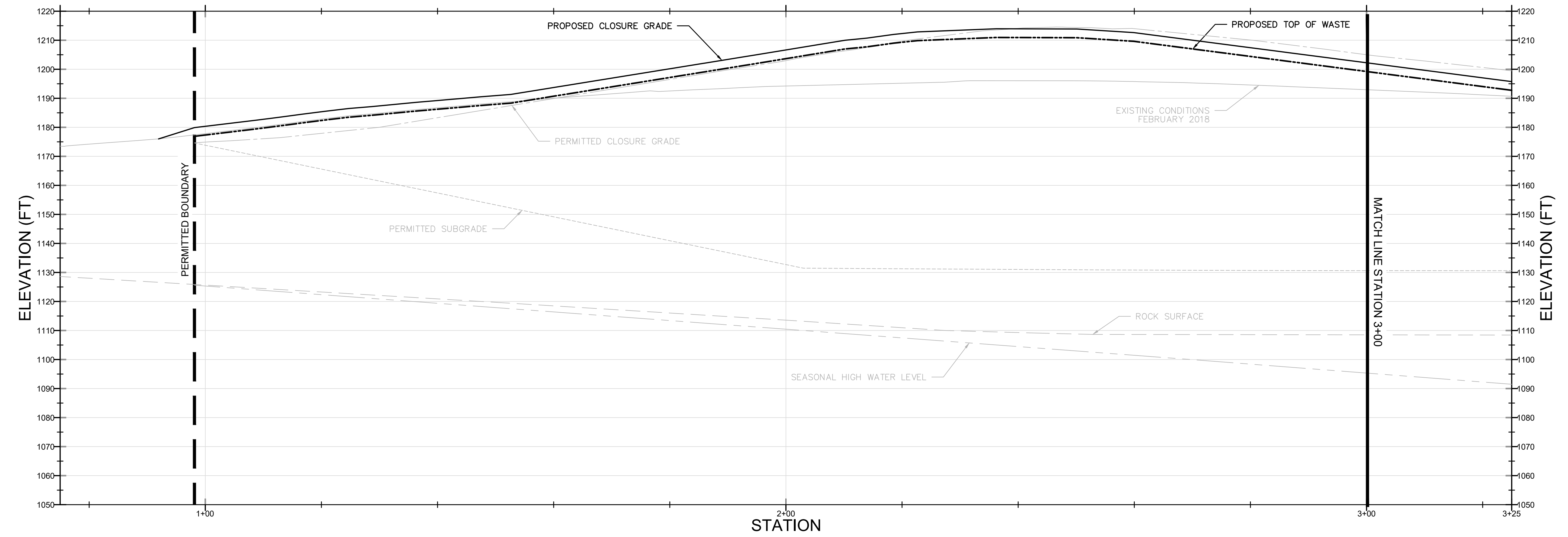

HORIZONTAL SCALE: 1" = 10'
VERTICAL SCALE: 1" = 20'

SECTION - E 13+00

LEGEND	
—	PROPOSED CLOSURE GRADE
---	PERMITTED SUBGRADE
-.-.-	PERMITTED CLOSURE GRADE 2006
- - -	PERMITTED PHASE F-2 BOUNDARY
- - - -	TOP OF WASTE
---	ROCK SURFACE
---	EXISTING CONDITIONS
---	APPROX. SEASONAL HIGH WATER LEVEL

- SOURCE NOTES:**
- PERMITTED SUBGRADE GRADES FROM MAY 2017, CREATED FROM DRONE SURVEY PROVIDED BY APPLIED ENGINEERING & MANAGEMENT CORPORATION OR 2006 PERMIT MODIFICATION DRAWINGS PREPARED BY QUANTUM ENVIRONMENTAL AND ENGINEERING SERVICES, LLC..
 - LANDFILL SURFACE GRADES OBTAINED FROM FEBRUARY 8, 2018 PHOTOGRAMMETRIC SURVEY BY TECHMAP.
 - EXISTING BEDROCK SURFACES ARE APPROXIMATE AND WERE CREATED USING 2006 PERMIT MODIFICATION DRAWINGS PREPARED BY QUANTUM ENVIRONMENTAL AND ENGINEERING SERVICES, LLC.

C:\Users\paul\OneDrive\Desktop\Permit Mod\Drawings\130706-07 - SECTION - E 13+00 - E 13+00 Section View.dwg, Plot Date: 09/21/18, Plot Scale: 1/16" = 1'-0", Plot Path: \\scs\paul\OneDrive\Desktop\Permit Mod\Drawings\130706-07 - SECTION - E 13+00 - E 13+00 Section View.dwg

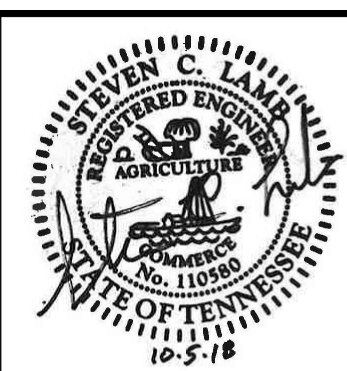

NO.	REVISION	DATE
1	REVISED PER TDEC COMMENTS	6/8/18
2	REVISED PER TDEC COMMENTS	9/21/18
3		
4		
5		

SHEET TITLE: **NORTH 3+00 SECTION VIEW**
 PROJECT TITLE: **WCA YARNELL ROAD LANDFILL MAJOR PERMIT MODIFICATION**

CLIENT: **WASTE CORPORATION OF TENNESSEE, LLC**
 1550 LAMONS QUARRY LANE
 KNOXVILLE, TENNESSEE 37992

SCS ENGINEERS
 2520 WHITEHALL PARK DRIVE, SUITE 450
 CHARLOTTE, NORTH CAROLINA 28273
 PHONE: (704) 504-3107 FAX: (704) 504-3174
 PROJ. NO. 17-3006.02 DATE: 07/30/18
 DRAWN BY: SCL CHECK BY: OJH APPR. BY: SCL

CADD FILE: SHT06-07 SE...
 DATE: **SEPTEMBER 2018**
 SCALE: **AS SHOWN**
 DRAWING NO. **7A** of 12

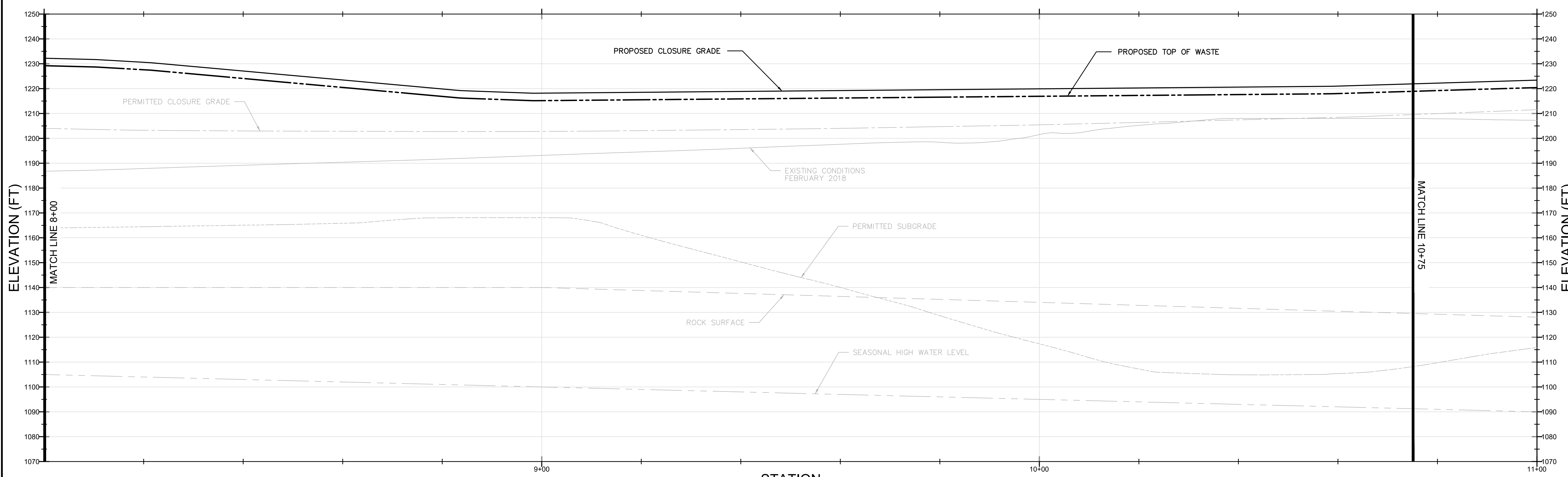
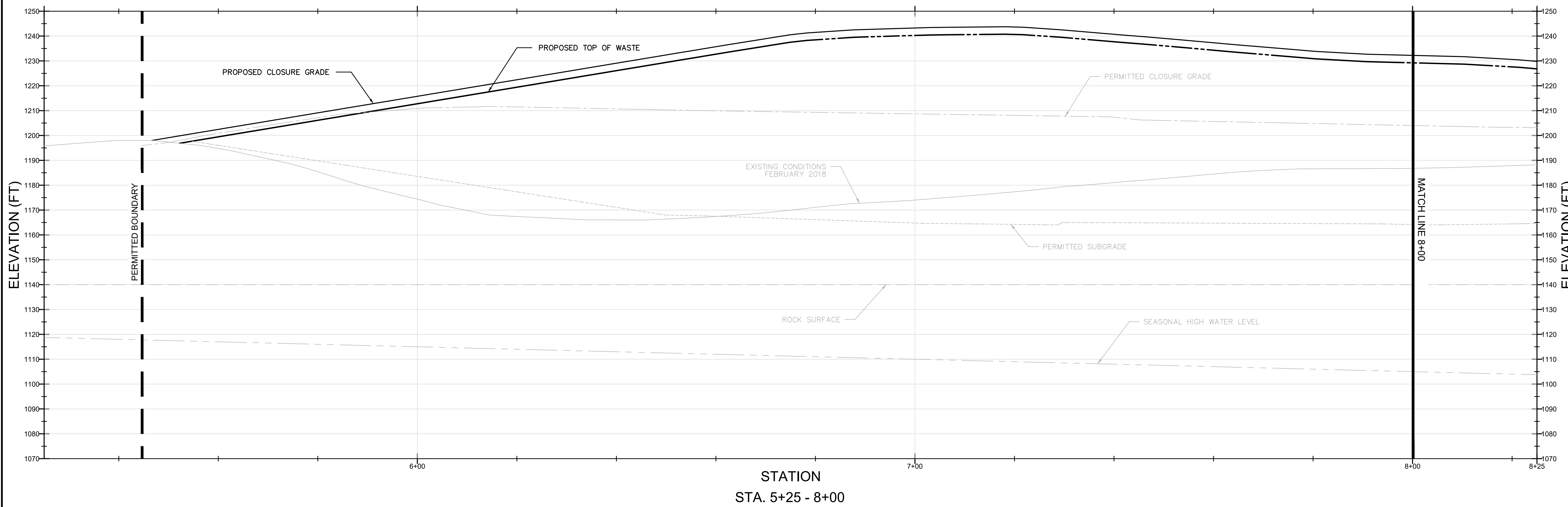

SECTION - N 3+00
 HORIZONTAL SCALE: 1" = 10'
 VERTICAL SCALE: 1" = 20'

LEGEND			
—	PROPOSED CLOSURE GRADE	—	TOP OF WASTE
- - -	PERMITTED SUBGRADE	- - -	ROCK SURFACE
· · ·	PERMITTED CLOSURE GRADE 2006	- - -	EXISTING CONDITIONS
- - -	PERMITTED PHASE F-2 BOUNDARY	- - -	APPROX. SEASONAL HIGH WATER LEVEL

- SOURCE NOTES:**
- PERMITTED SUBGRADE GRADES FROM MAY 2017, CREATED FROM DRONE SURVEY PROVIDED BY APPLIED ENGINEERING & MANAGEMENT CORPORATION OR 2006 PERMIT MODIFICATION DRAWINGS PERPARED BY QUANTUM ENVIRONMENTAL AND ENGINEERING SERVICES, LLC.
 - LANDFILL SURFACE GRADES OBTAINED FROM FEBRUARY 8, 2018 PHOTOGRAMMETRIC SURVEY BY TECHMAP.
 - EXISTING BEDROCK SURFACES AND SEASONAL HIGH WATER LEVELS ARE APPROXIMATE AND WERE CREATED USING 2006 PERMIT MODIFICATION DRAWINGS PREPARED BY QUANTUM ENVIRONMETANL AND ENGINEERING SERVICES, LLC.
 - BEDROCK INFORMATION FOR SECTION N 3+00 WAS INTERPOLATED FROM EAST CROSS SECTIONS. BEDROCK IS PROVIDED FROM STA. E 7+00 TO E 13+00.

I:\CADD\PROJECTS\2018\17-3006\Drawings\070706-07 - SECTION - NORTH 3+00 SECTION VIEW.dwg 09/21/18 10:30am Exported Asm - Sheet 7A.dwg

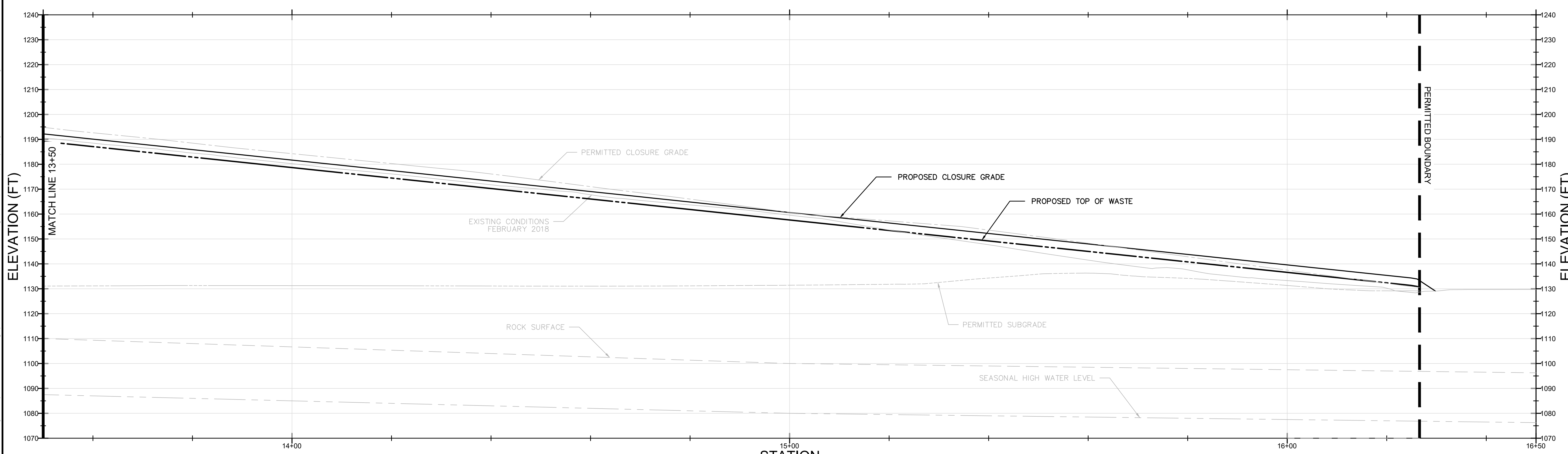
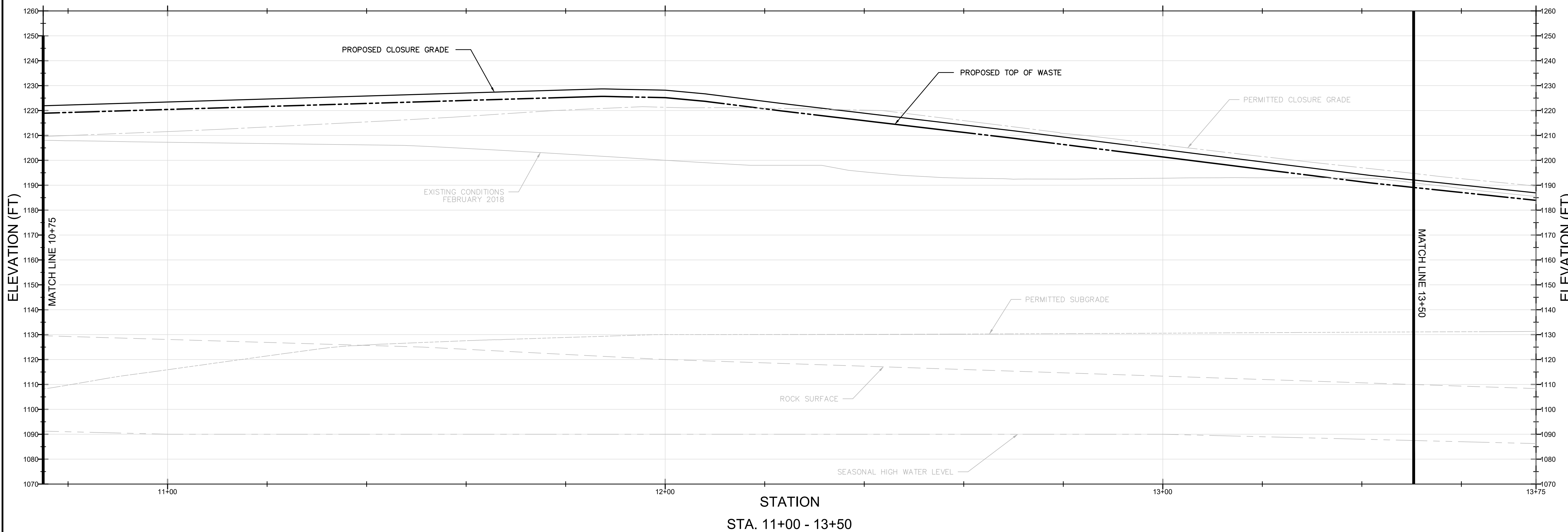

LEGEND			
	PROPOSED CLOSURE GRADE		TOP OF WASTE
	PERMITTED SUBGRADE		ROCK SURFACE
	PERMITTED CLOSURE GRADE 2006		EXISTING CONDITIONS
	PERMITTED PHASE F-2 BOUNDARY		APPROX. SEASONAL HIGH WATER LEVEL

STATION
 STA. 13+50 - 16+50
 HORIZONTAL SCALE: 1" = 10'
 VERTICAL SCALE: 1" = 20'
SECTION - N 3+00

- SOURCE NOTES:**
- PERMITTED SUBGRADE GRADES FROM MAY 2017, CREATED FROM DRONE SURVEY PROVIDED BY APPLIED ENGINEERING & MANAGEMENT CORPORATION OR 2006 PERMIT MODIFICATION DRAWINGS PERPARED BY QUANTUM ENVIRONMENTAL AND ENGINEERING SERVICES, LLC.
 - LANDFILL SURFACE GRADES OBTAINED FROM FEBRUARY 8, 2018 PHOTOGRAMMETRIC SURVEY BY TECHMAP.
 - EXISTING BEDROCK SURFACES AND SEASONAL HIGH WATER LEVELS ARE APPROXIMATE AND WERE CREATED USING 2006 PERMIT MODIFICATION DRAWINGS PREPARED BY QUANTUM ENVIRONMETANL AND ENGINEERING SERVICES, LLC.
 - BEDROCK INFORMATION FOR SECTION N 3+00 WAS INTERPOLATED FROM EAST CROSS SECTIONS. BEDROCK IS PROVIDED FROM STA. E 7+00 TO E 13+00.

NO.	REVISION	DATE
1	REVISED PER TDEC COMMENTS	6/8/18
2	REVISED PER TDEC COMMENTS	9/21/18

SHEET TITLE
NORTH 3+00 SECTION VIEW
 PROJECT TITLE
WCA YARNELL ROAD LANDFILL MAJOR PERMIT MODIFICATION

CLIENT
WASTE CORPORATION OF TENNESSEE, LLC
 1550 LAMONS QUARRY LANE
 KNOXVILLE, TENNESSEE 37932

SCS ENGINEERS
 2520 WHITEHALL PARK DRIVE, SUITE 450
 CHARLOTTE, NORTH CAROLINA 28273
 PHONE: (704) 504-3107 FAX: (704) 504-3174
 PROJ. NO. 150227306.02
 DATE: 02/27/2018
 DRAWN BY: JCT
 CHECKED BY: OJH
 APPR. BY: SCL

CADD FILE:
 SHT06-07 SE...
 DATE:
 SEPTEMBER 2018
 SCALE:
 AS SHOWN
 DRAWING NO.
7B of 12

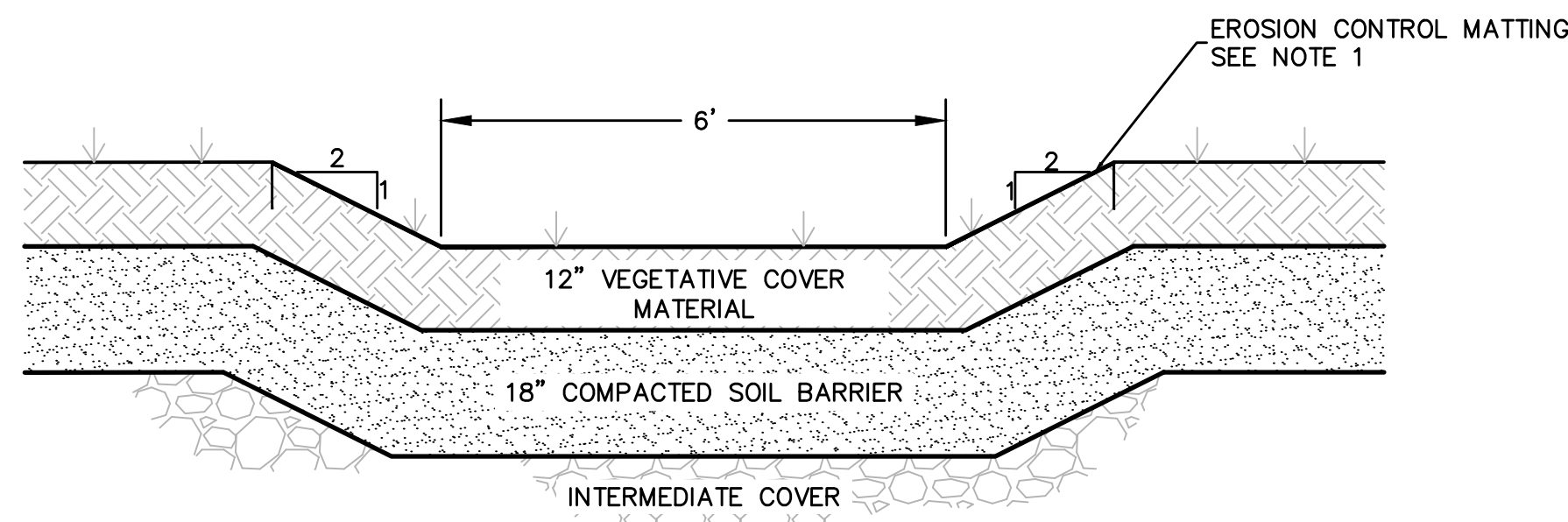

NOTES:

1. SEE MANUFACTURERS RECOMMENDATION FOR ANCHORING OF EROSION CONTROL MATTING.
2. SEE DETAIL 1 ON THIS SHEET FOR TYPICAL COVER REQUIREMENTS.

GRASS LINED DOWN CHUTE DETAIL (5/8)
NTS

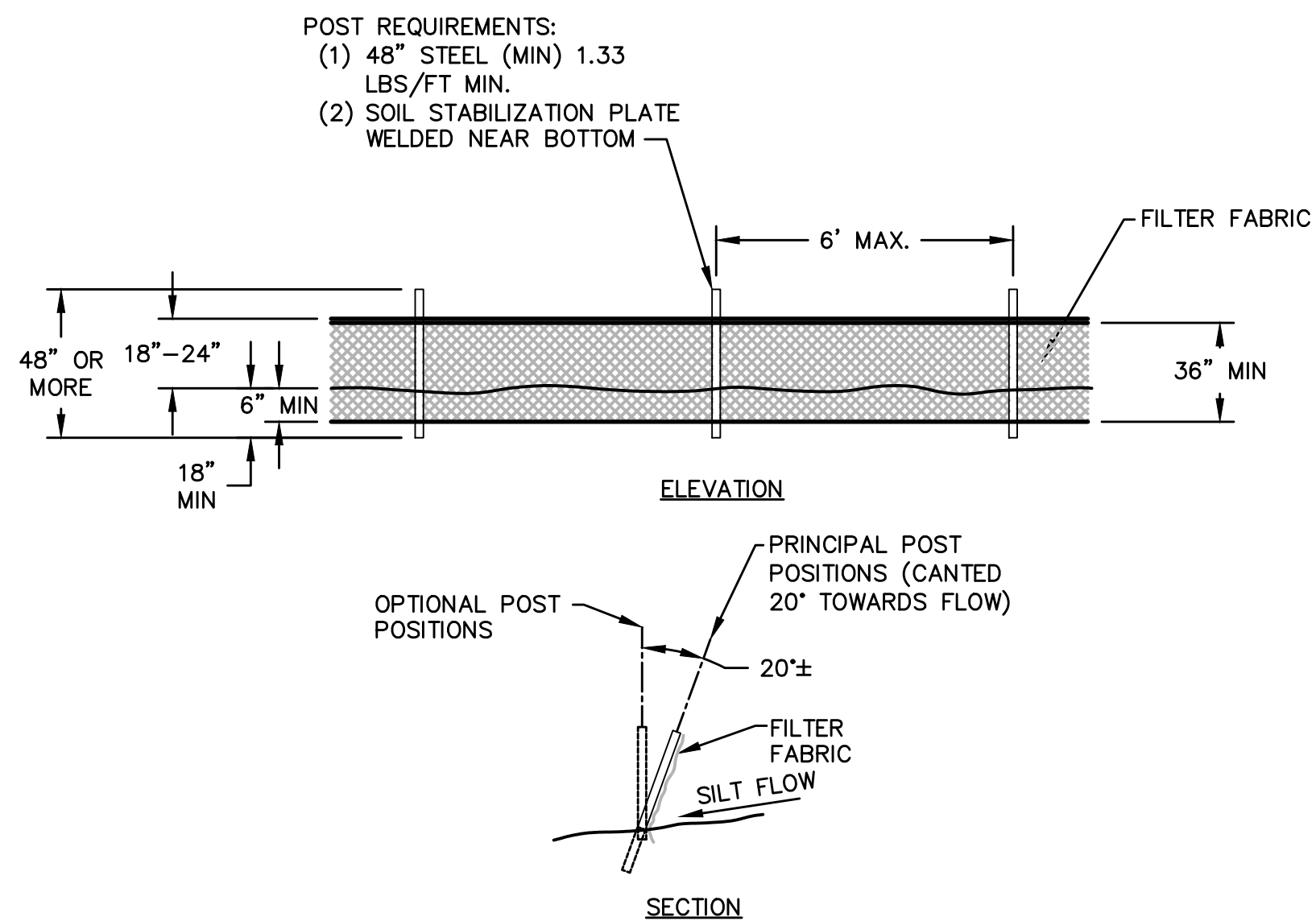

GENERAL NOTES

1. POSTS WHICH SUPPORT THE SILT FENCE SHALL BE INSTALLED ON A SLIGHT ANGLE TOWARD THE ANTICIPATED RUNOFF SOURCE. POSTS MUST BE EMBEDDED A MINIMUM OF EIGHTEEN (18) INCHES.
2. THE TOE OF THE SILT FENCE SHALL BE TRENCHED IN WITH A SPADE OR MECHANICAL TRENCHER, SO THAT THE DOWNSLOPE FACE OF THE TRENCH IS FLAT AND PERPENDICULAR TO THE LINE OF FLOW. WHERE FENCE CANNOT BE TRENCHED IN (E.G. PAVEMENT) WEIGHT FABRIC FLAP WITH WASHED GRAVEL ON UPHILL SIDE TO PREVENT FLOW UNDER FENCE.
3. THE TRENCH MUST BE A MINIMUM OF 6 INCHES DEEP AND 6 INCHES WIDE TO ALLOW FOR THE SILT FENCE FABRIC TO BE LAID IN THE GROUND AND BACKFILLED WITH COMPACTED MATERIAL.
4. SILT FENCE SHOULD BE SECURELY FASTENED TO EACH STEEL SUPPORT POST OR TO WOVEN WIRE, WHICH IS IN TURN ATTACHED TO THE STEEL FENCE POST.
5. INSPECT ALL EROSION AND SEDIMENTATION (E&S) CONTROL MEASURES WEEKLY AND WITHIN 24-HOURS AFTER EACH RAINFALL EVENT THAT PRODUCES 1/2-INCHES OR MORE PRECIPITATION. REPAIR ERODED AREAS AND E&S CONTROL MEASURES THAT NEED REPAIR AS SOON AS POSSIBLE.
6. SILT FENCE SHALL BE REMOVED WHEN THE SITE IS COMPLETELY STABILIZED SO AS NOT TO BLOCK OR IMPEDE STORM FLOW OR DRAINAGE.
7. ACCUMULATED SILT SHALL BE REMOVED WHEN IT REACHES A DEPTH OF 6 INCHES.
8. THE SILT SHALL BE DISPOSED IN AN APPROVED SITE AND IN SUCH A MANNER AS TO NOT CONTRIBUTE TO ADDITIONAL SILTATION.

SILT FENCE DETAIL (4/8)
NTS

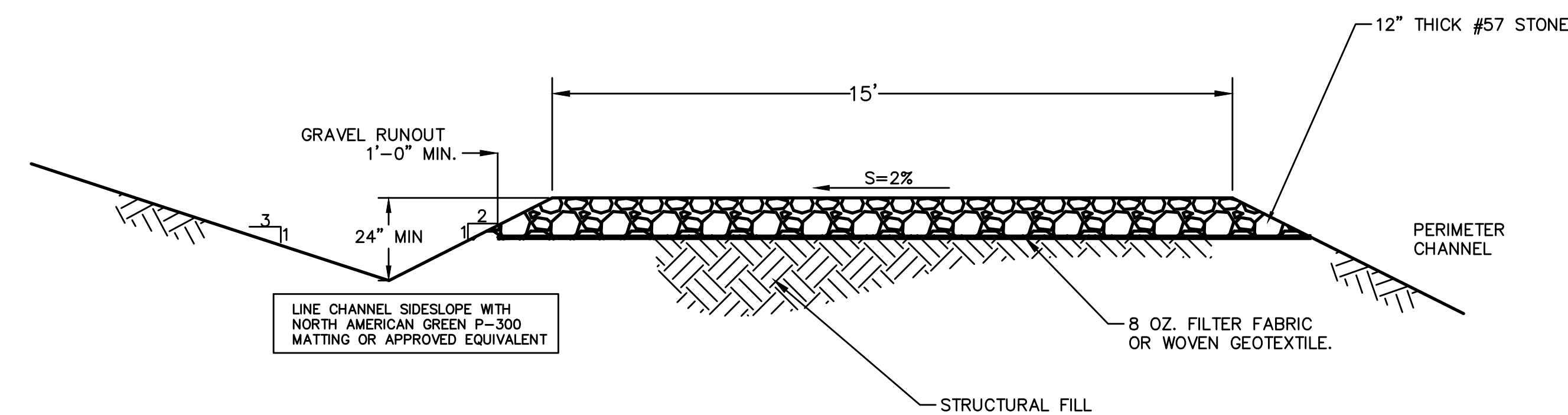

ACCESS ROAD AND DITCH (3/8)
NTS

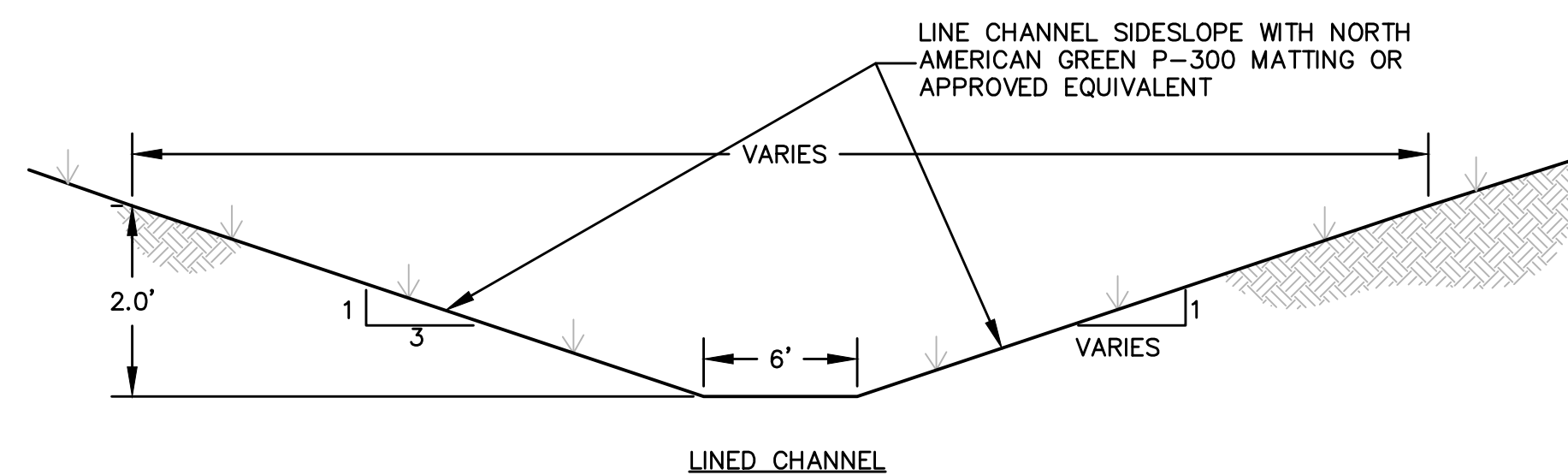

SOUTH STORMWATER CHANNEL DETAIL (2/8)
NTS

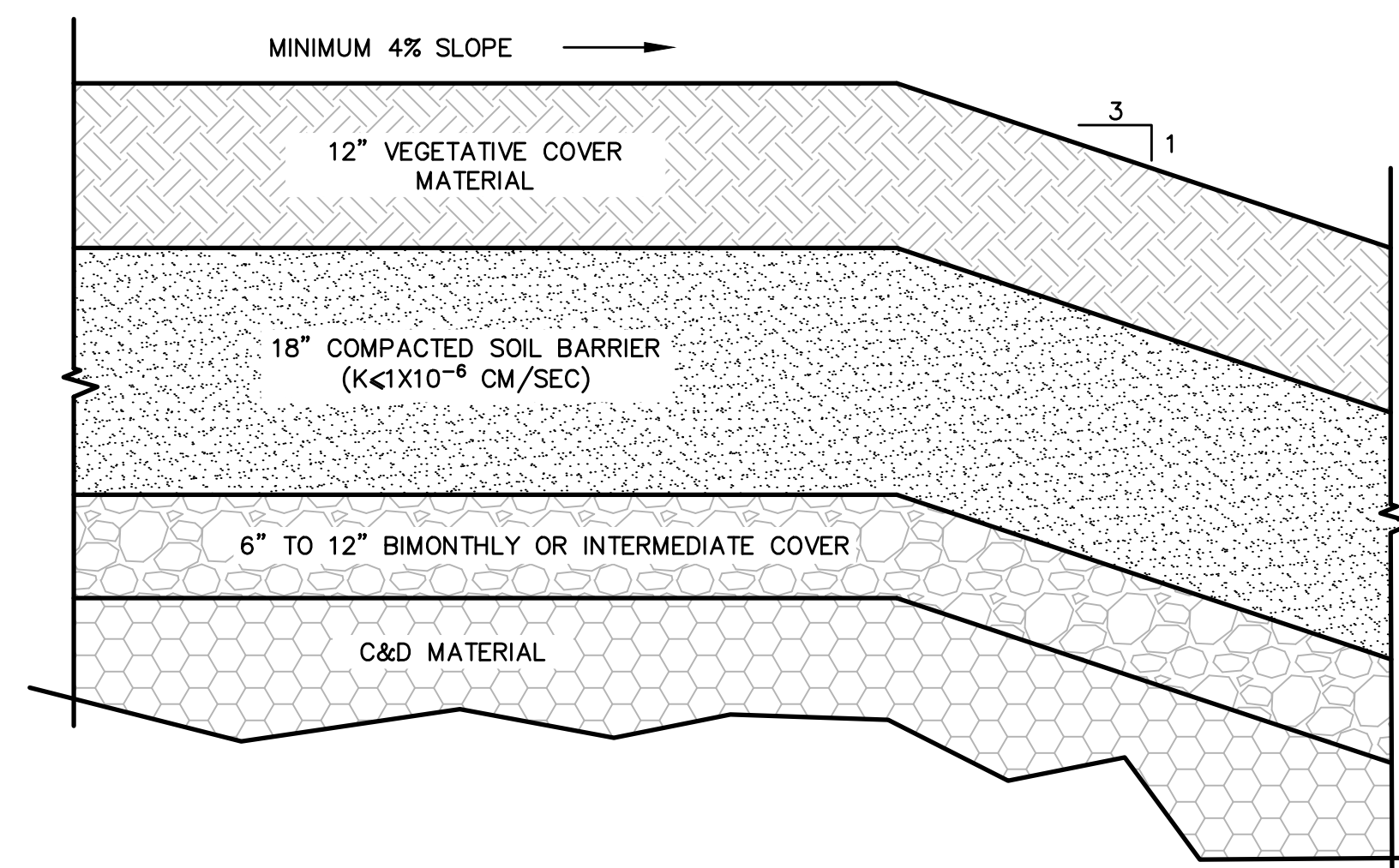

TYPICAL FINAL COVER DETAIL (1/8)
NTS

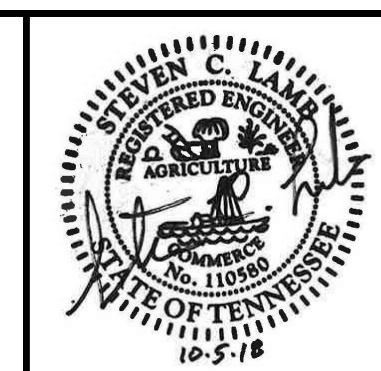

NO.	REVISION	DATE
1	REVISED PER IDEC COMMENTS	6/8/18
2	REVISED PER IDEC COMMENTS	9/21/18
3		
4		
5		

DETAILS 1
SHEET TITLE
PROJECT TITLE
WCA YARNELL ROAD LANDFILL MAJOR PERMIT MODIFICATION

CLIENT
WASTE CORPORATION OF TENNESSEE, LLC
1550 LAMONS QUARRY LANE
KNOXVILLE, TENNESSEE 37992

SCS ENGINEERS
2520 WHITEHALL PARK DRIVE, SUITE 450
CHARLOTTE, NORTH CAROLINA 28273
PHONE: (704) 504-3107 FAX: (704) 504-3174
DRAWN BY: JCT
CHECKED BY: OJH
DATE: 02/27/2018
SCALE: SCL

CADD FILE:
SHT08-DETAIL...
DATE:
SEPTEMBER 2018
SCALE:
AS SHOWN

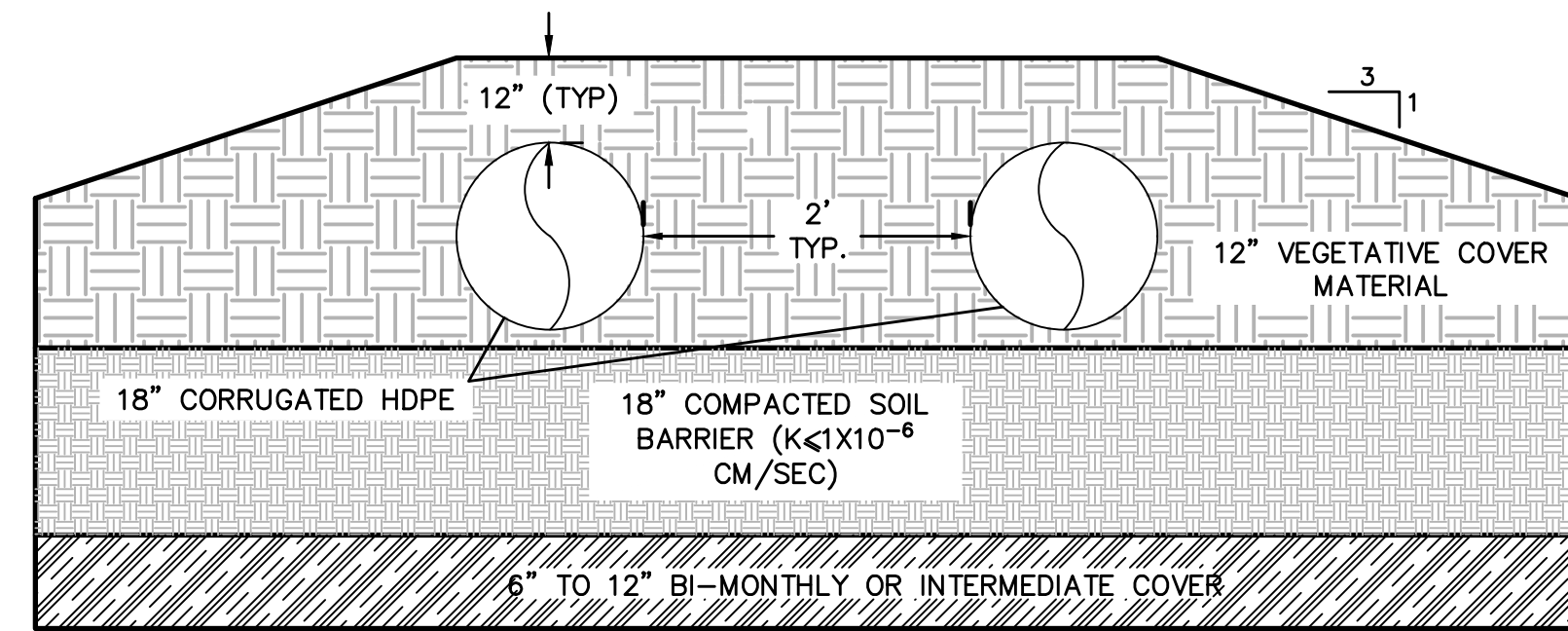

FINAL COVER AT DOWN CHUTE
NTS

4
5 | 9

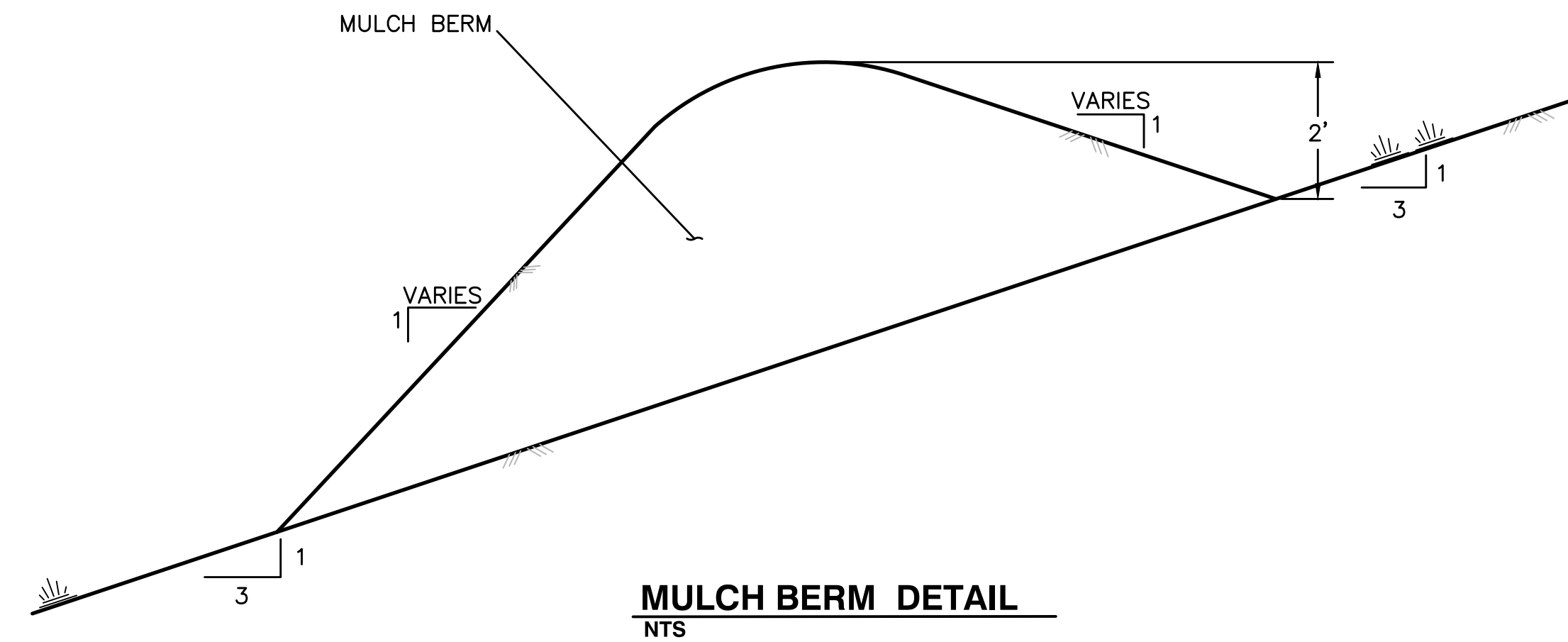

MULCH BERM DETAIL
NTS

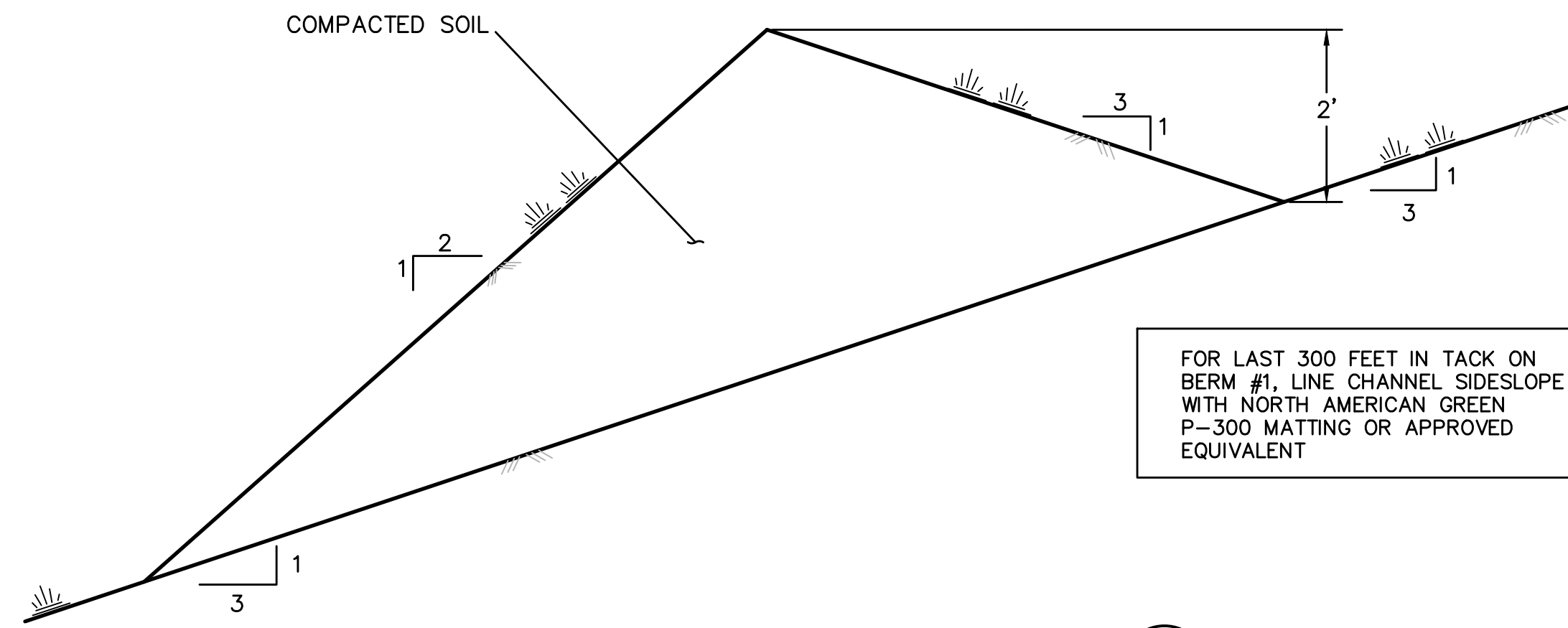

SIDE SLOPE TACK-ON BERM DETAIL
NTS

2
5 | 9

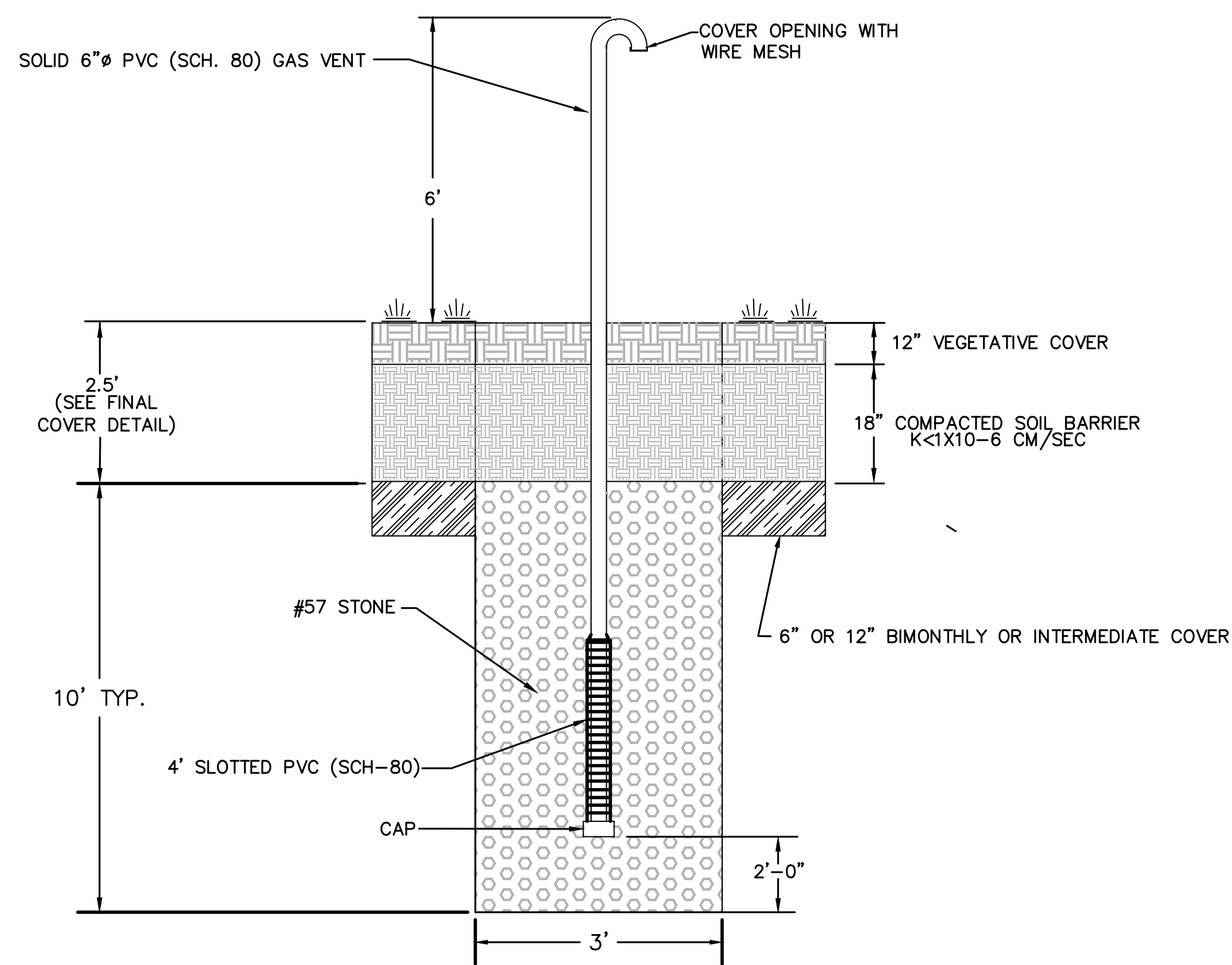

TYPICAL GAS VENT DETAIL
NTS

3
4 | 9

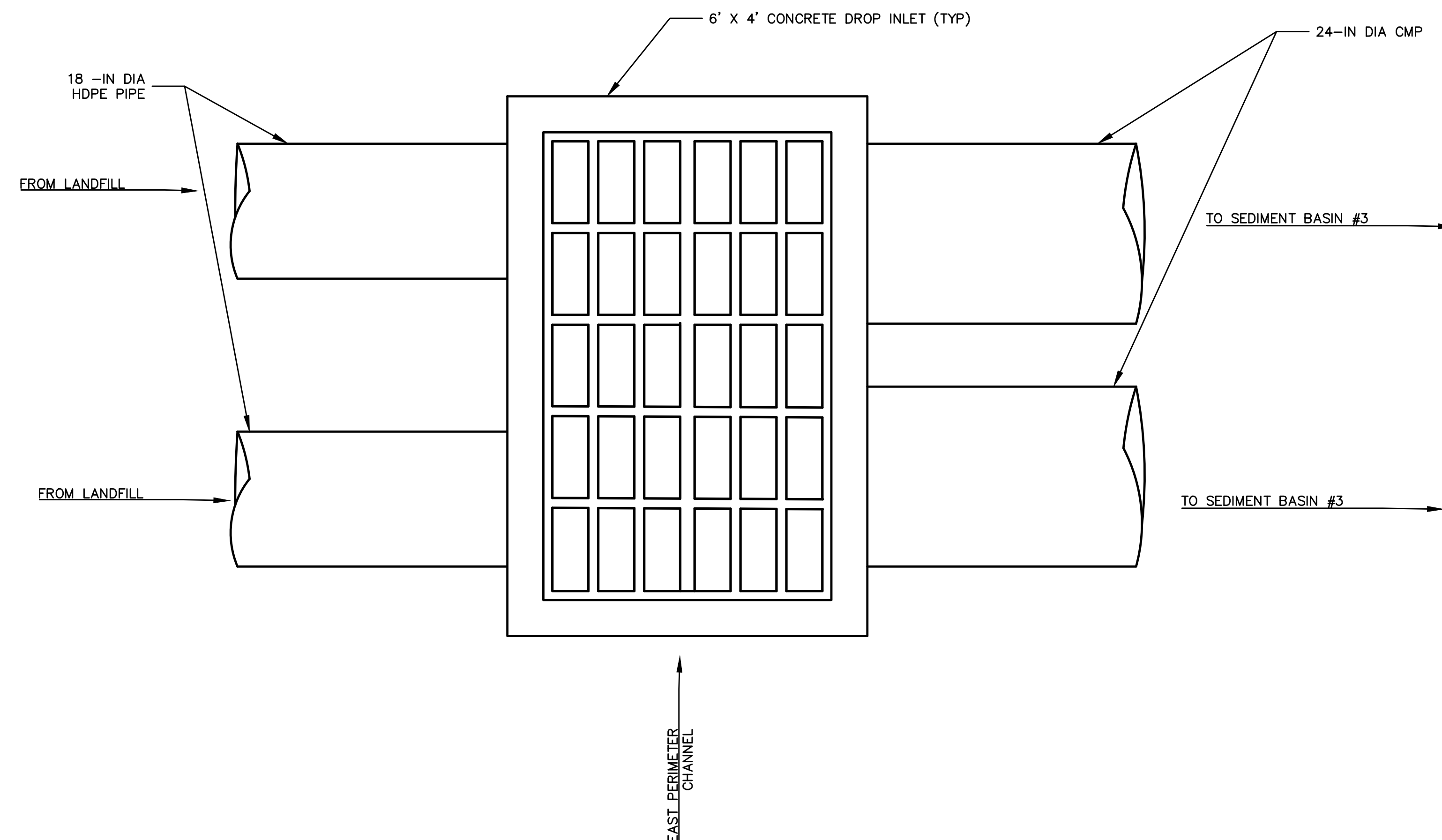

DROP INLET DETAIL
NTS

1
5 | 12 | 9

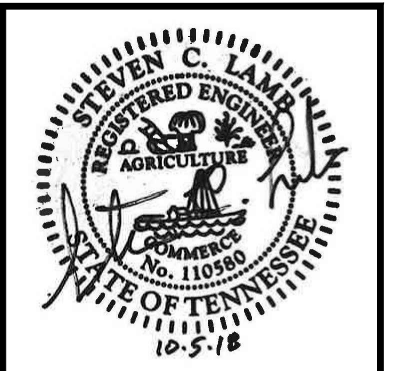

NO.	REVISION	DATE
1	REVISED PER TDEC COMMENTS	6/8/18
2	REVISED PER TDEC COMMENTS	9/21/18
3		
4		

SHEET TITLE: **DETAILS 2**
PROJECT TITLE: **WCA YARNELL ROAD LANDFILL MAJOR PERMIT MODIFICATION**

CLIENT: **WASTE CORPORATION OF TENNESSEE, LLC**
1550 LAMONS QUARRY LANE
KNOXVILLE, TENNESSEE 37932

SCS ENGINEERS
2520 WHITEHALL PARK DRIVE, SUITE 450
CHARLOTTE, NORTH CAROLINA 28273
PHONE: (704) 504-3107 FAX: (704) 504-3174
PROJ. NO.: 02217.506.02
DATE: 09/21/18
DWN. BY: JCT
CHK. BY: OJH
APP. BY: SCL

CADD FILE: SHT09-DETAIL...
DATE: SEPTEMBER 2018
SCALE: AS SHOWN
DRAWING NO.

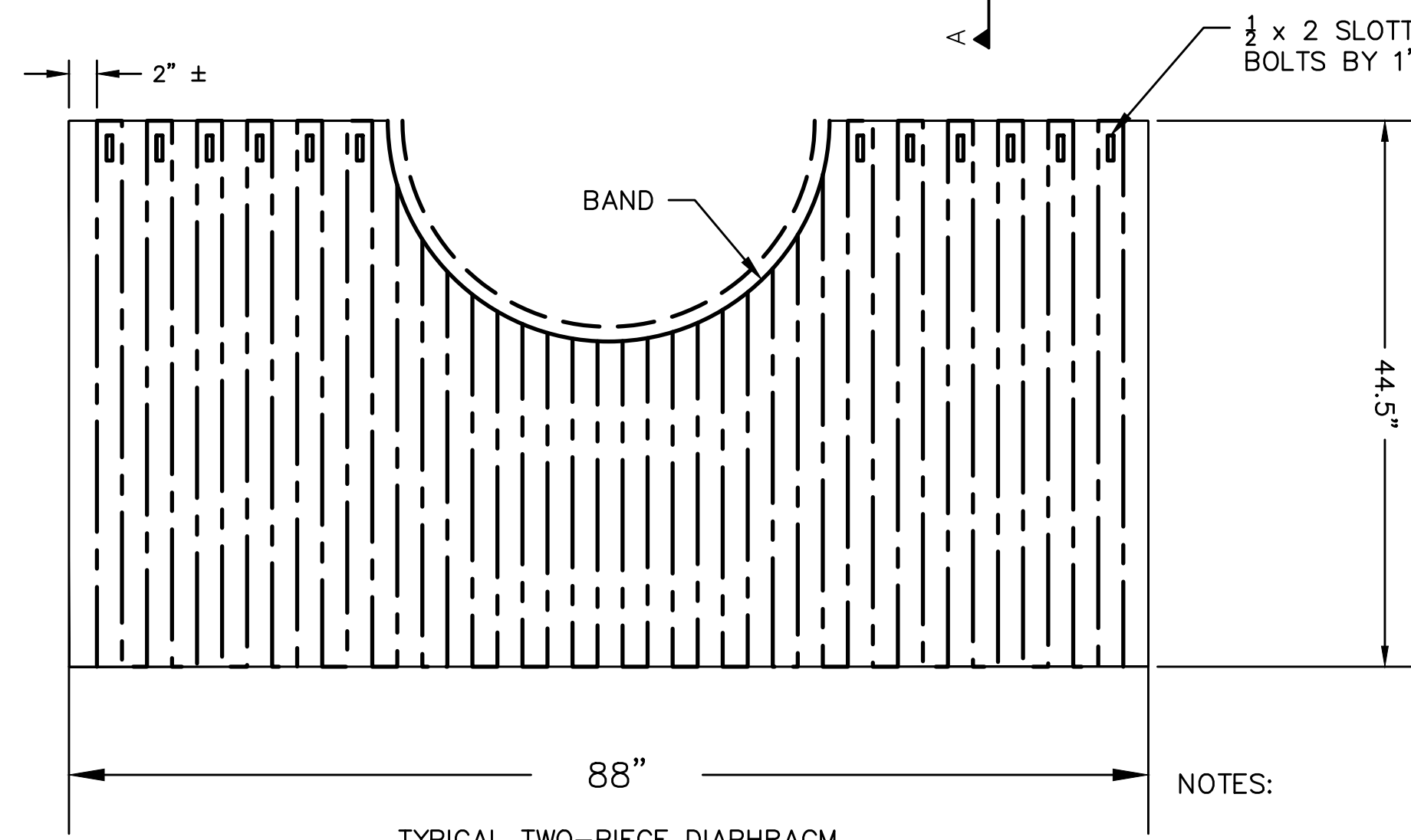
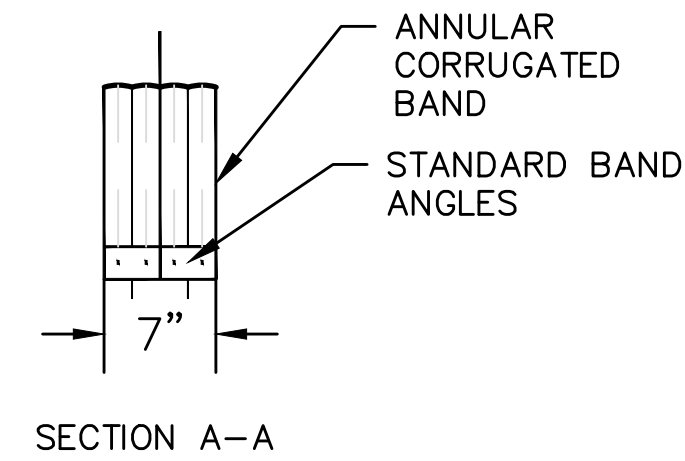
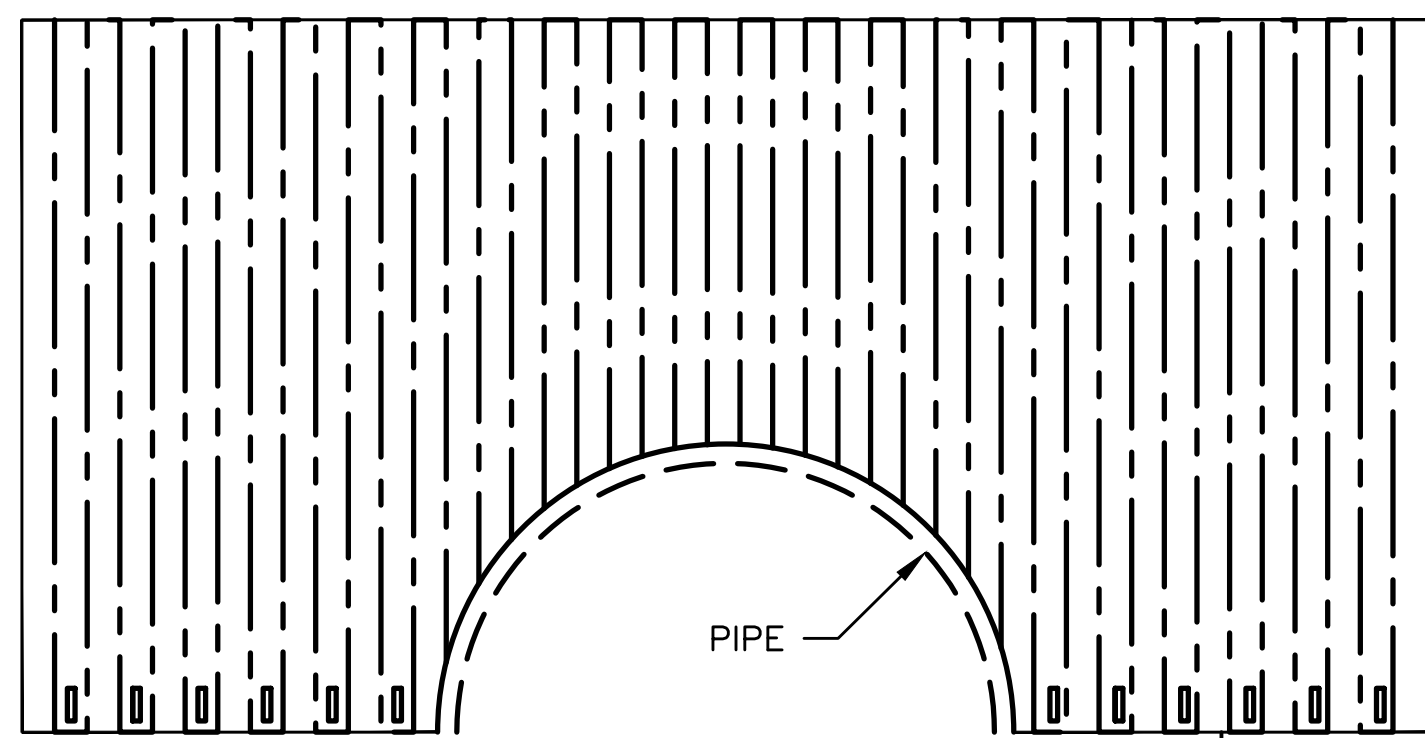

NOTES:

1. BAND IS CORRUGATED TO MATCH REROLLED END OF PIPE BEING JOINED.
2. EACH DIAPHRAGM SHALL BE FASTENED WITH (4) 1/2" X 6" BOLTS AND (8) 3/8" X 1" BOLTS.
3. COLLARS SHALL EXTEND A MINIMUM OF 2' AROUND THE BARREL.

ANTI - SEEP COLLAR
NTS

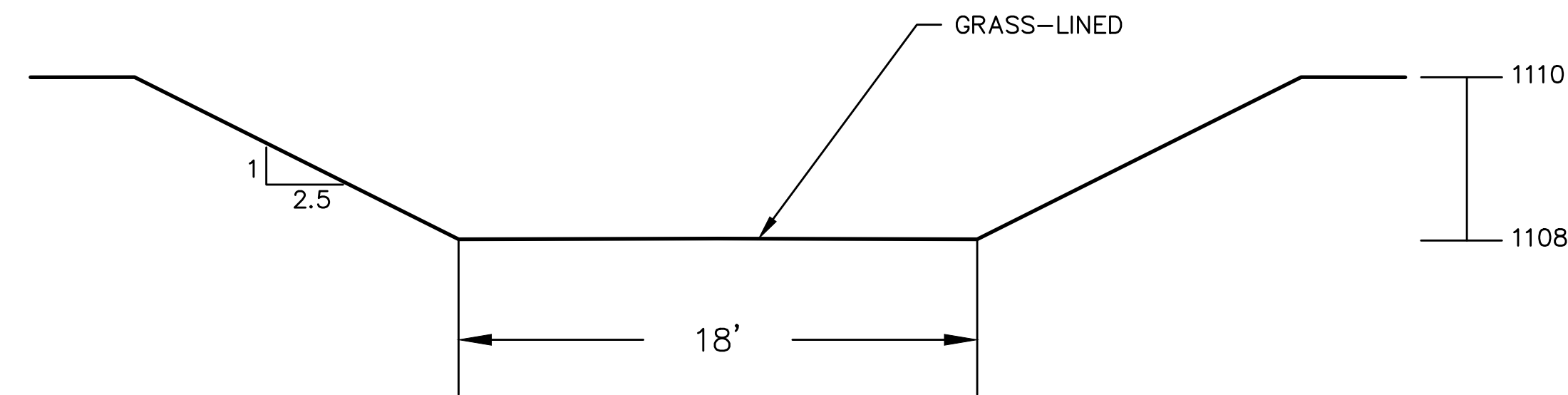

EMERGENCY SPILLWAY CROSS SECTION 3
NTS 5/10

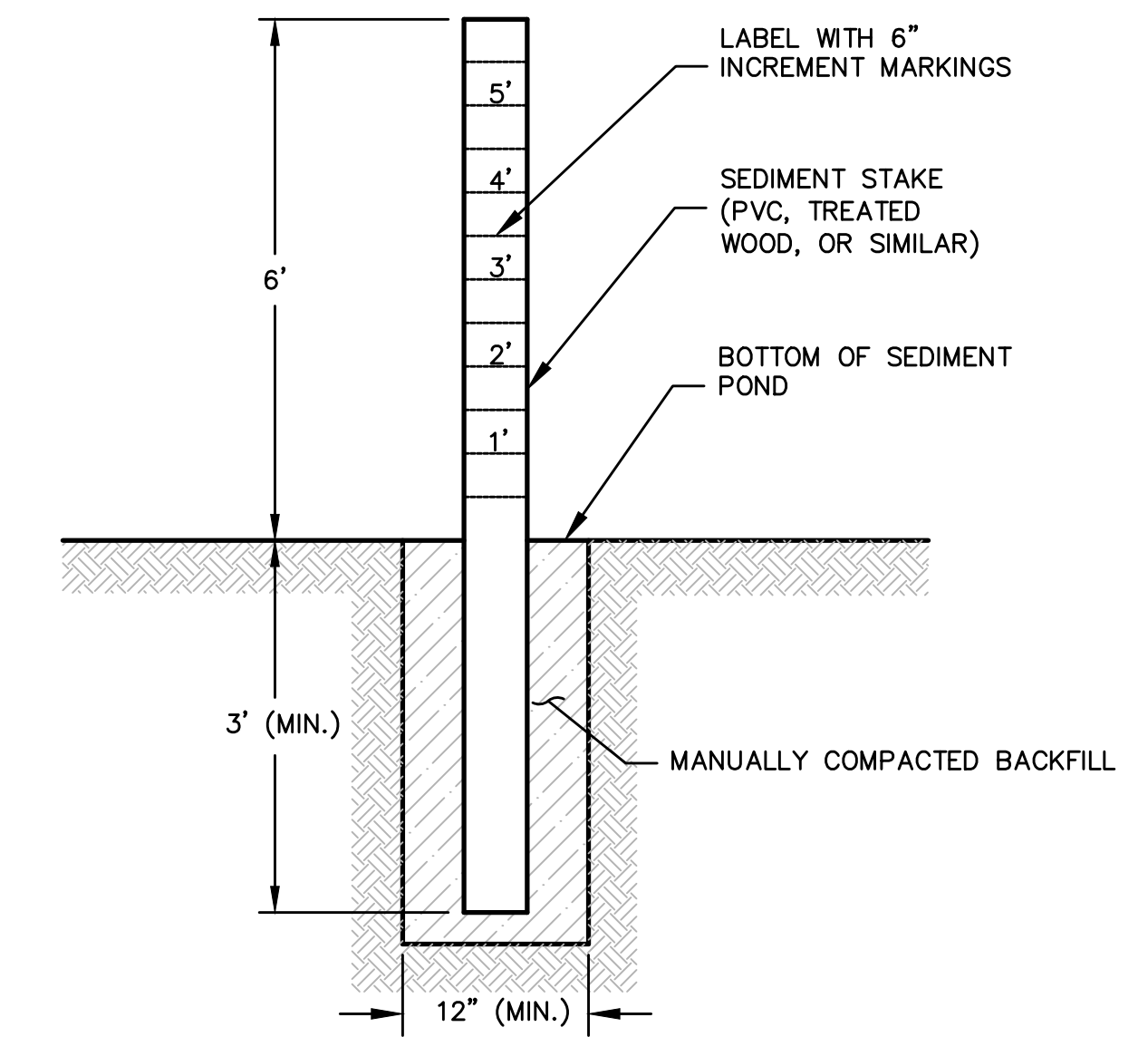

SEDIMENT CLEANOUT STAKE DETAIL 2
NTS 5/10

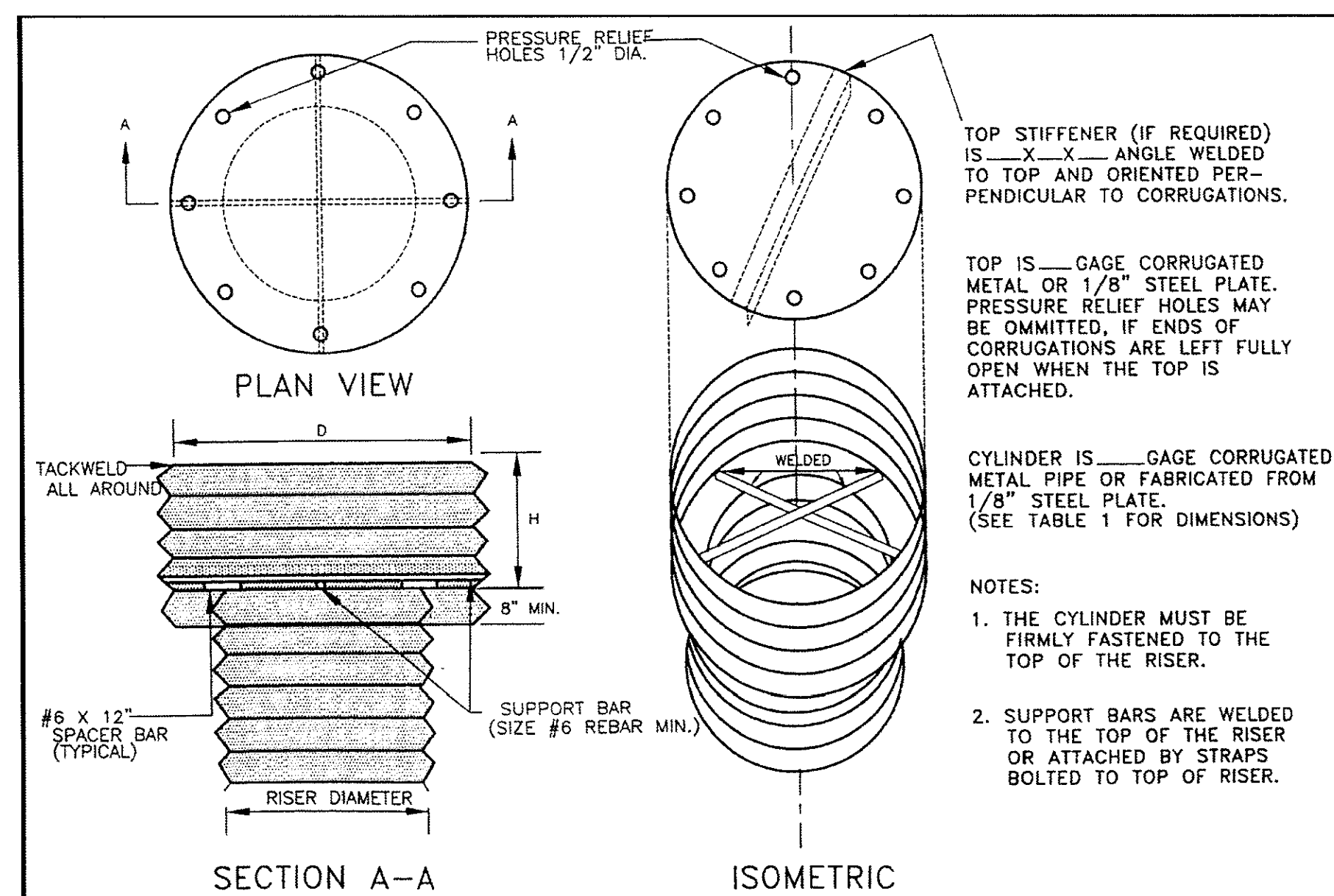

NOTES:

1. ANTI-VORTEX DESIGN OBTAINED FROM THE TENNESSEE EROSION & SEDIMENT CONTROL HANDBOOK, FOURTH EDITION, AUGUST 2012.
2. FOR THE 36 INCH DIAMETER RISER, THE ANTI-VORTEX CYLINDER SHALL BE 14 GAGE WITH 54 INCH DIAMETER AND HEIGHT OF 17 INCHES.
3. THE MINIMUM SUPPORT BAR SHALL BE #8 REBAR AND THE CORRUGATED TOP SHALL BE 14 GAGE.

ANTI - VORTEX DEVICE
NTS

36-INCH CMP PRINCIPAL RISER SPILLWAY WITH TRASH RACK AND ANTI-VORTEX PLATE (ELEV. 1107)

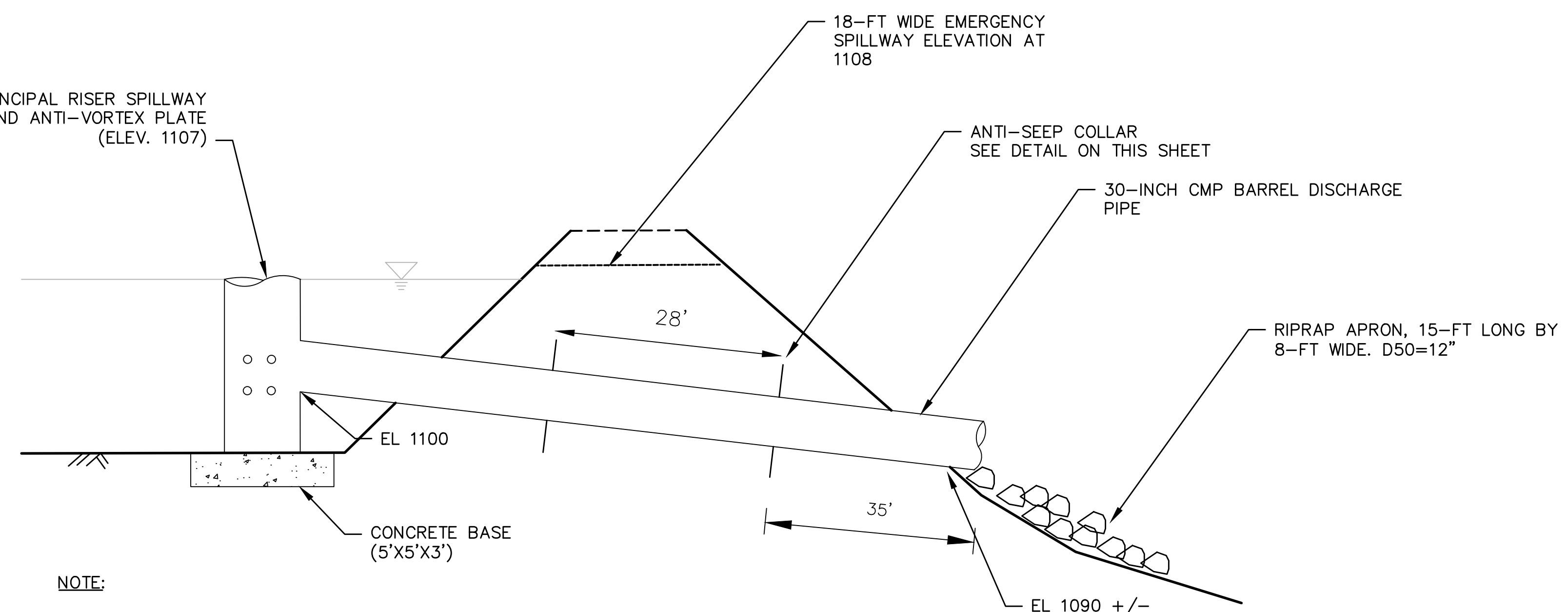
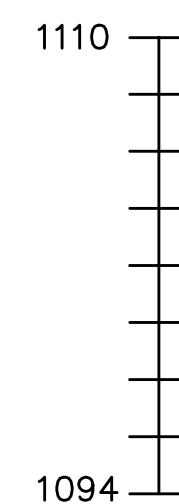

NOTE:

1. INSTALL TWO ROWS OF 1-IN DIA. PERFORATIONS AT ELEVATION 1100 AND 1102. SEVEN PERFORATIONS PER ROW.

SEDIMENT BASIN 3 CROSS SECTION 1
NTS 5/10



NO.	REVISION	DATE
1	REVISED PER TDEC COMMENTS	6/8/18
2	REVISED PER TDEC COMMENTS	9/21/18

DETAILS 3
PROJECT TITLE
WCA YARNELL ROAD LANDFILL MAJOR PERMIT MODIFICATION

CLIENT
WASTE CORPORATION OF TENNESSEE, LLC
1550 LAMONS QUARRY LANE
KNOXVILLE, TENNESSEE 37932

SCS ENGINEERS
2520 WHITEHALL PARK DRIVE, SUITE 450
CHARLOTTE, NORTH CAROLINA 28273
PHONE: (704) 504-3107 FAX: (704) 504-3174
PROJ. NO. 1706.02
DWG. BY: JCT
CHK. BY: OJH
APP. BY: SCL

CADD FILE:
SHT10-DETAIL...
DATE:
SEPTEMBER 2018
SCALE:
AS SHOWN
DRAWING NO.

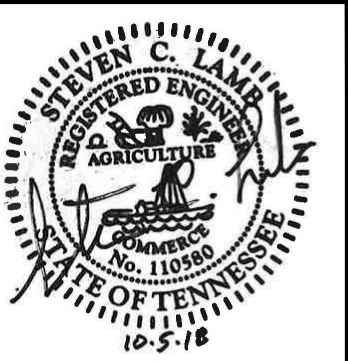

NO.	REVISION	DATE
1	REVISED PER TDEC COMMENTS	6/8/18
2	REVISED PER TDEC COMMENTS	9/21/18
3		
4		
5		

SHEET TITLE: **DETAILS 4**
 PROJECT TITLE: **WCA YARNELL ROAD LANDFILL MAJOR PERMIT MODIFICATION**

CLIENT: **WASTE CORPORATION OF TENNESSEE, LLC**
 1550 LAMONS QUARRY LANE
 KNOXVILLE, TENNESSEE 37932

SCS ENGINEERS
 2520 WHITEHALL PARK DRIVE, SUITE 450
 CHARLOTTE, NORTH CAROLINA 28273
 PHONE: (704) 504-3107 FAX: (704) 504-3174
 DWG. BY: JCT O/A RW BY: SCL
 CHK. BY: OJH APP. BY: SCL

CADD FILE: SHT09-DETAIL...
 DATE: SEPTEMBER 2018
 SCALE: AS SHOWN
 DRAWING NO.

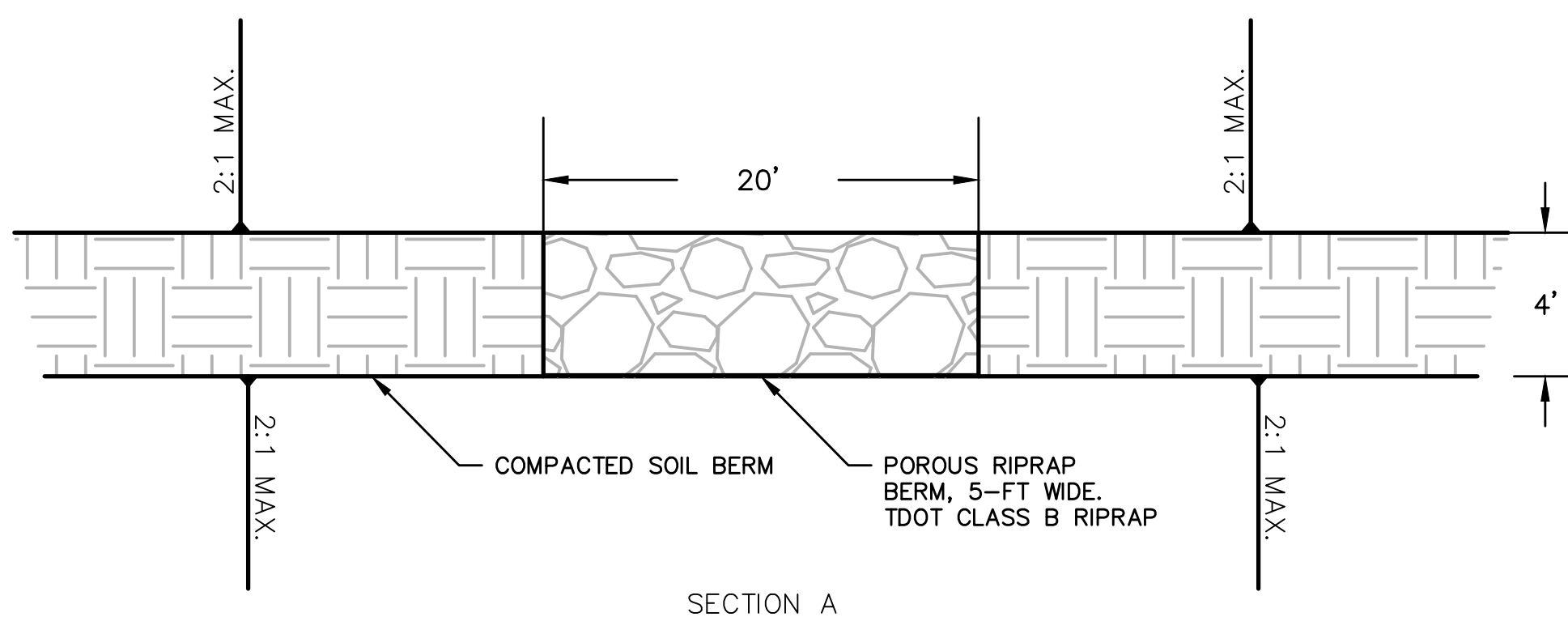
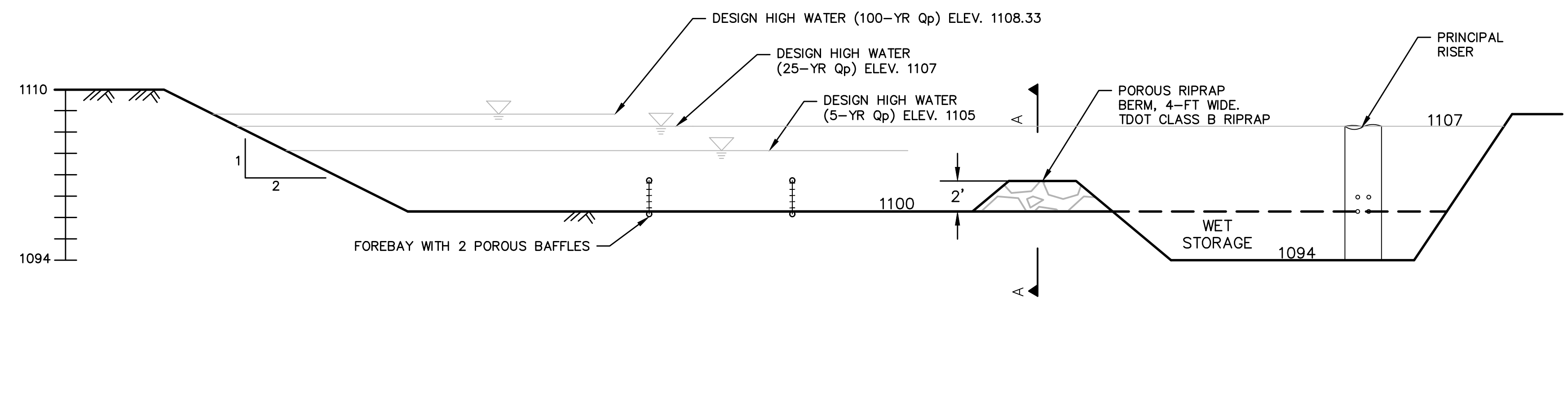

SEDIMENT BASIN FOREBAY DETAIL (3)
 NTS (5/11)

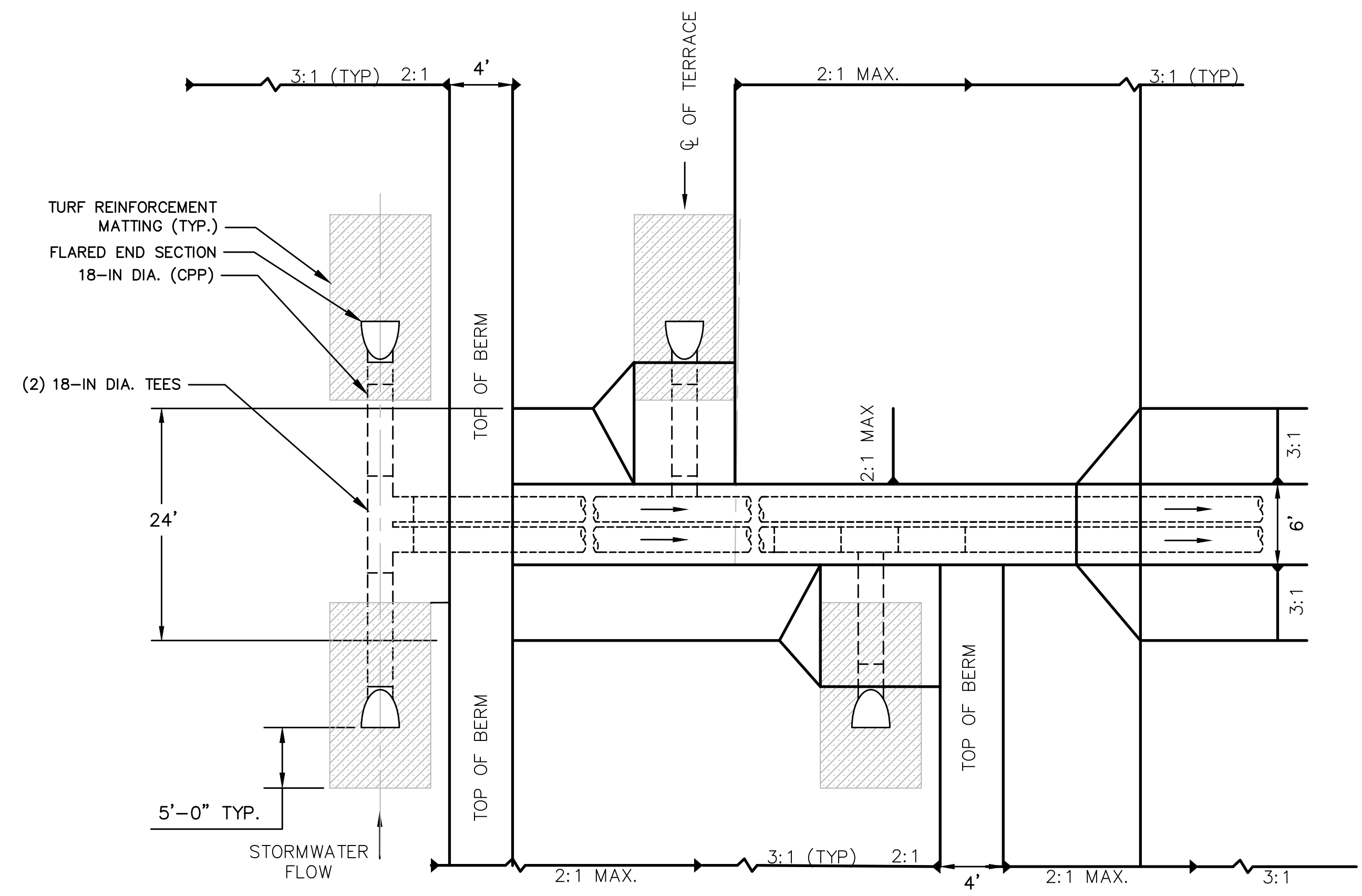

- NOTE:
- CORRUGATED PLASTIC PIPE (CPP) SHALL BE DOUBLE WALL SMOOTH CORE PIPE. SOIL TIGHT ADS N-12, OR ENGINEER APPROVED EQUAL.

DOUBLE DOWNCHUTE DRAIN PIPE & SIDESLOPE DRAINAGE BERM INLET CONNECTION DETAIL (2)
 NTS (5/11)

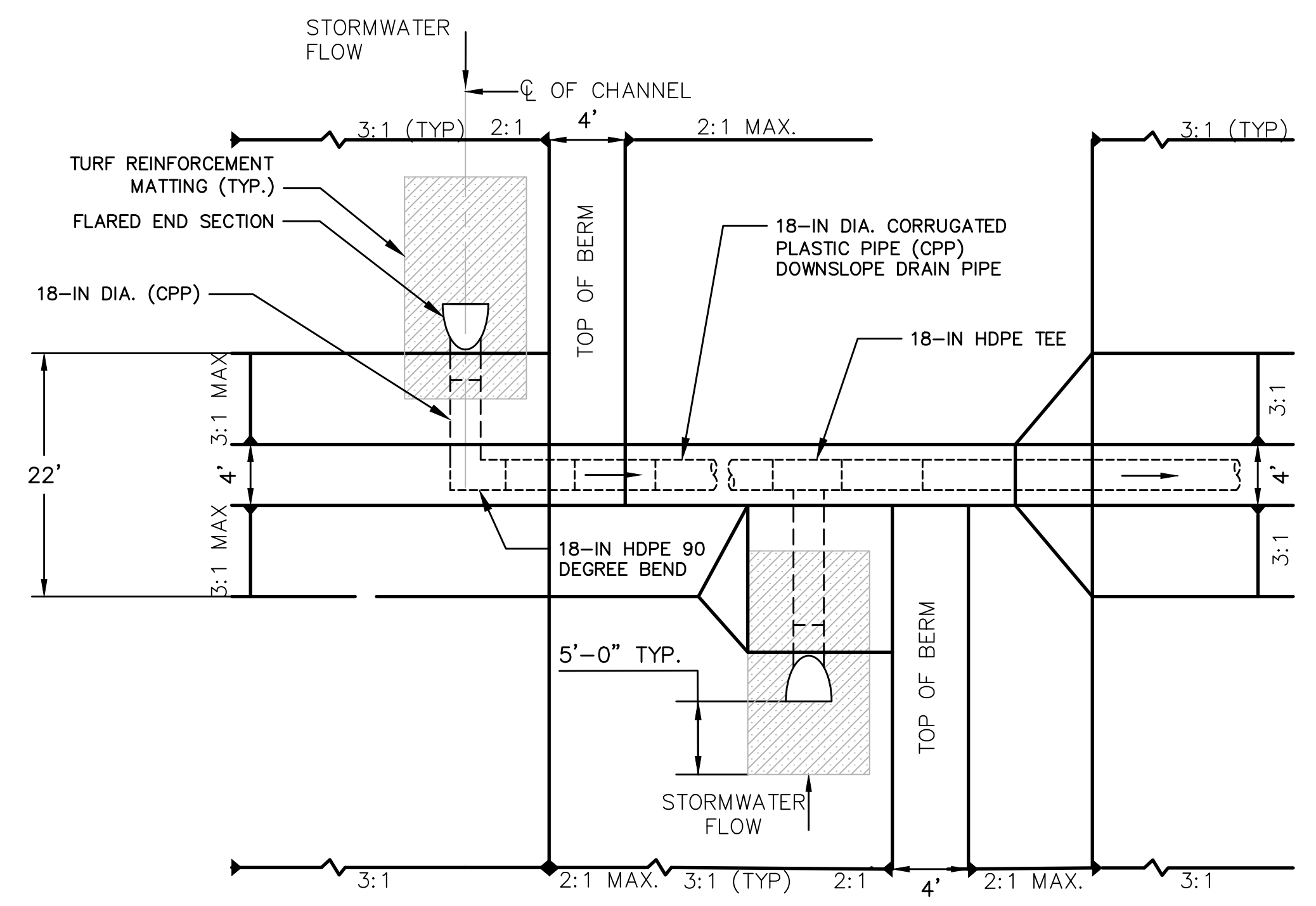

- NOTE:
- CORRUGATED PLASTIC PIPE (CPP) SHALL BE DOUBLE WALL SMOOTH CORE PIPE. SOIL TIGHT ADS N-12, OR ENGINEER APPROVED EQUAL.

SINGLE DOWNCHUTE DRAIN PIPE & SIDESLOPE DRAINAGE BERM INLET CONNECTION DETAIL (1)
 NTS (5/12)



NO.	REVISION	DATE
1	ADDED PER TDEC COMMENTS	9/21/18
2		
3		
4		
5		

SHEET TITLE: **DOWN CHUTE PROFILES**
 PROJECT TITLE: **WCA YARNELL ROAD LANDFILL MAJOR PERMIT MODIFICATION**

CLIENT: **WASTE CORPORATION OF TENNESSEE, LLC**
 1550 LAMONS QUARRY LANE
 KNOXVILLE, TENNESSEE 37932

SCS ENGINEERS
 2520 WHITEHALL PARK DRIVE, SUITE 450
 CHARLOTTE, NORTH CAROLINA 28273
 PHONE: (704) 504-3107 FAX: (704) 504-3174
 PROJ. NO. 17-206.02 O/A RW BY: SCL
 TSSA BY: SCL CHK BY: OJH APP. BY: SCL

CADD FILE: SHT12-DOWN...
 DATE: SEPTEMBER 2018
 SCALE: AS SHOWN
 DRAWING NO.

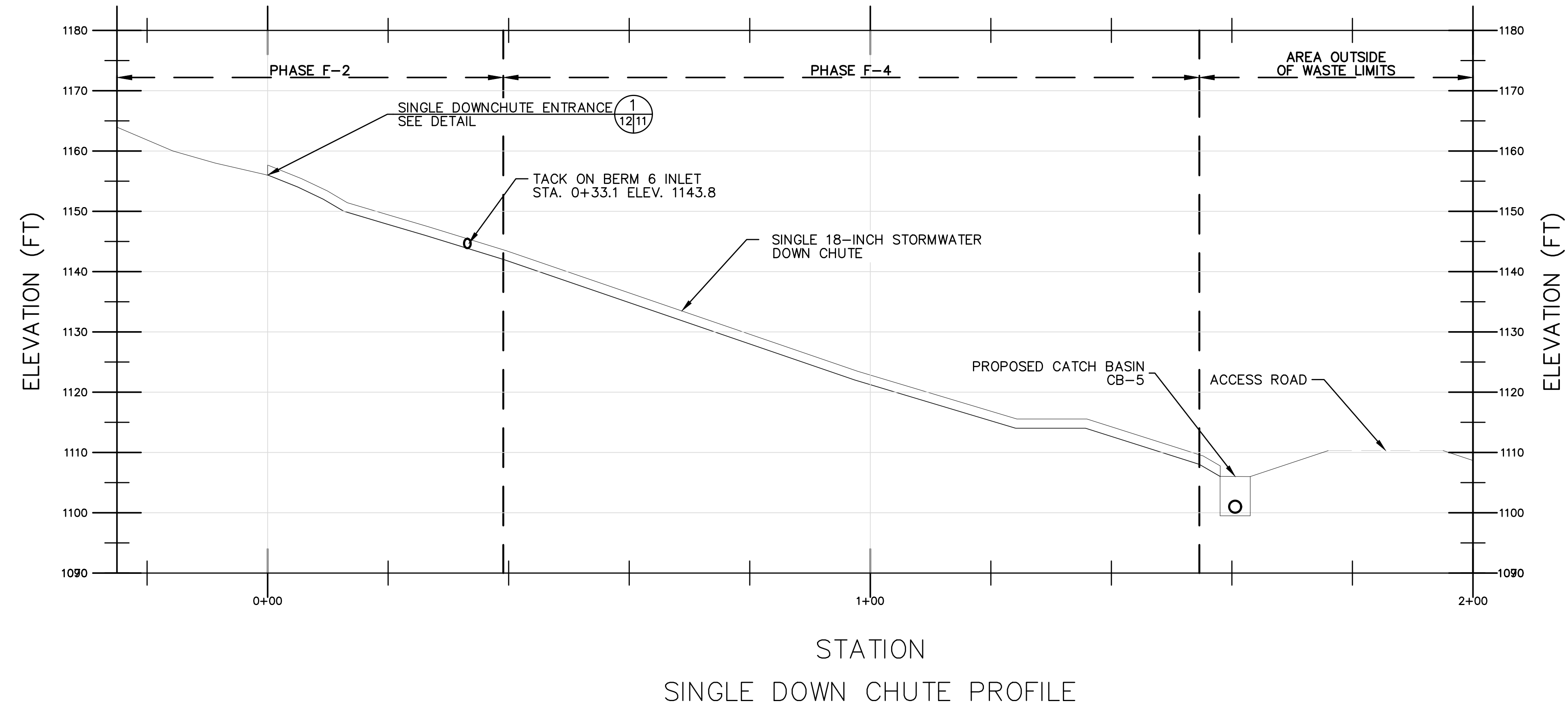
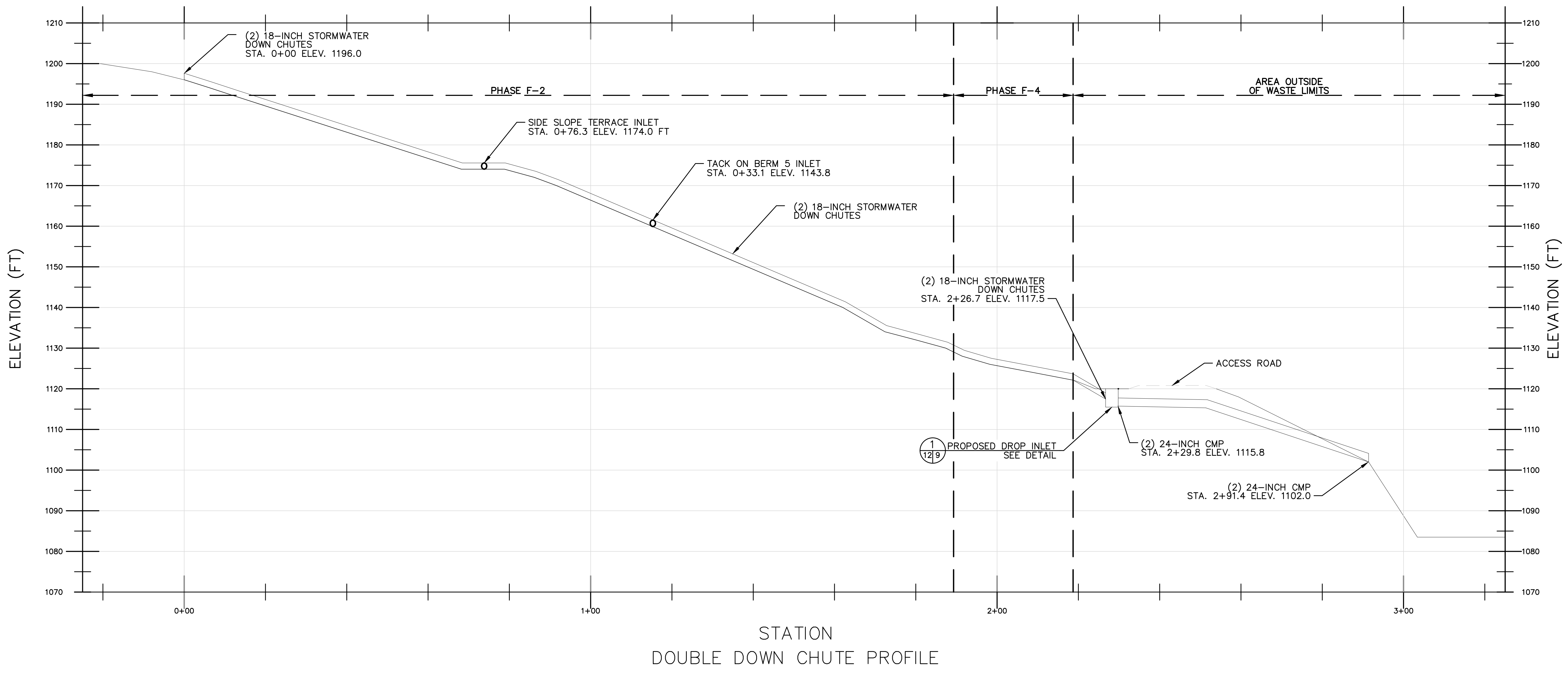

APPENDIX B



STORMWATER CALCULATIONS

By: Orion Holtey

Checked by: Steve Lamb

PURPOSE

Establish the amount of run-off generated from the landfill closure during a 25-year, 24 hour storm. The runoff quantities will be used to calculate the proper sizing of stormwater best management practices (BMPs) that include grassed swales, side slope berms, side slope down chutes, rip rap channels and storm culverts.

REFERENCES

1. Tennessee Department of Environment and Conservation – Erosion and Sediment Control Handbook, Fourth Edition, August 2012
2. Knox County Tennessee Stormwater Management Manual, January 2008
3. Technical Release 55 (TR-55) Urban Hydrology for Small Watersheds Design Manual, June 1986.

GIVEN

1. The landfill was divided into 15 drainage areas, designated A-1 thru A-3, B-1, B-2, C, D-1 thru D-5, and E thru H.
2. Each drainage area drains to a series of landfill side slope tack-on berms, HDPE pipe down chutes, perimeter channel, or outfall structure.
3. The berm channel is a minimum of 2-feet in depth and the perimeter channel provides a 1-foot minimum freeboard.
4. Maximum allowable length of sheet flow is approximately 100 feet.

MAJOR ASSUMPTIONS

1. Manning's number for grassed channel, $n = 0.033$. For HDPE pipe, $n = 0.012$. For corrugated metal pipes, $n = 0.022$. For rip-rap lined channels, $n = 0.072$.
2. Runoff coefficient of 84 was used for grassed side slopes. A weighed runoff coefficient of 85 used for the side slopes with grass and roadway.
3. Knox County Tennessee Stormwater Management Manual Chapter 3 for Knox County rainfall intensities. (**Reference 1**)
4. Design Storm for 25-yr/24-hr, $i = 5.5$ inches.

GENERAL INFORMATION

- a. Twelve post development BMP structures, and the corresponding drainage areas as identified on the Basin Delineation Map are analyzed in these calculations:
 - BMP 1 – Tack on Berms (TB): The side slope tack on berms are proposed to direct runoff to the stormwater pipes. The largest drainage area of 1.69 acres, which is for TB-2 (Drainage Area C), was used and one cross section is proposed for all 6 TBs.

- In addition, velocities were checked for all tack on berms. Only the last 300 feet of TB-1 requires an erosion matting because its velocity is greater than 5 fps.
- BMP 2a – Side slope Stormwater Pipe; a single 18-inch diameter pipe from TB-1 and TB-6. The drainage area conveyed by this pipe is 1.80 acres from Drainage areas A-1, A-2, and A-3.
- BMP 2b: Side slope Stormwater Pipes; Two 18-inch diameter HDPE pipes are proposed from TB-2, TB-5, and the proposed Side Slope Terrace. The drainage area is 2.56 acres from Drainage areas B-1, B-2, and C.
- BMP 3 – Access Road Ditch: The drainage area conveyed by this ditch is approximately 1.07 acres from drainage area D-1.
- BMP 4 – South Perimeter Channel: The drainage area conveyed by this channel is 2.96 acres from drainage areas D-1 thru D-5.
- BMP 5 – Southeast Perimeter Channel: The drainage area conveyed by this channel is received from 3.61 acres which includes 2.96 acres from BMP 4 and 0.65 acres from Drainage Area E.
- BMP 6 – Proposed 24-inch Culvert from proposed Catch Basin 5 (CB-5) to proposed Manhole 4 (MH-4). Drainage area is from drainage area F and BMP 2a which equal 4.07 acres.
- BMP 7 – Proposed 24-inch Culverts to Sediment Basin 3: The drainage area conveyed by these culverts is from 6.17 acres which includes 2.56 acres from BMP 2b and 3.61 acres from BMP-5.
- BMP 8 – Proposed drop inlet: The proposed drop inlet conveys runoff from southeast channel (BMP-5). Drainage area = 3.61 acres.
- BMP 9 – Proposed Side Slope Terrace: The drainage area conveyed by this terrace is 0.61 acres from drainage area B-1.
- BMP 10 - Northeast Perimeter Channel: The drainage area conveyed by this channel is received from drainage area G (0.26 acres).
- BMP 11 – South Down Chute: Two down chutes are proposed along the south slope directing runoff from Tack on Berms 3 and 4. Drainage area D-2 (TB-3) has the largest drainage area (0.50 acres) and was used to design the cross section for both down chutes.

- BMP 12 – Sedimentation Basin 3 (SB-3): The existing Sedimentation Basin has been enlarged to receive additional runoff from 7.51 acres.
 - BMP 13 – Southwest Channel: The drainage area conveyed by this channel is received from drainage area I (1.54 acres).
- b. Based on previous calculations and to be conservative, the time of concentration (TOC) for all drainage areas was assumed to be 6 minutes (minimum recommended for use of the TR-55 manual). The drainage areas were used to identify flows directed as result of the proposed expansion. All time of concentrations were quick with only 3 exceeding the TR-55 6-minute minimum. As a result, the unit peak discharge of 1,000 was used for all calculations of flow rate (Q). The adjusted unit peak discharges provides for a slightly higher, more conservative flow rate.

ATTACHMENTS

1. Peak Discharge Calculations.
2. Drainage Area Map (Also refer to Drawing 5 of the Permit Drawings)
3. Hydraflow Reports – BMP Calculations
4. Sediment Basin 3 Calculations

CALCULATIONS

Peak flows are summarized in the Table below. TR-55 output data is provided in **Attachment 1** of these calculations.

Basin Name	Area (acres)	25-year Flow (cfs)
Drainage Area A-1	0.39	2.27
Drainage Area A-2	1.17	6.82
Drainage Area A-3	0.24	1.40
Drainage Area B-1	0.61	3.56
Drainage Area B-2	0.26	1.52
Drainage Area C	1.69	10.12
Drainage Area D-1	1.07	6.41
Drainage Area D-2	0.50	2.91
Drainage Area D-3	0.52	3.03
Drainage Area D-4	0.28	1.63
Drainage Area D-5	0.59	3.44
Drainage Area E	0.65	3.79
Drainage Area F	2.27	13.23
Drainage Area G	0.26	1.52
Drainage Area H	1.08	6.30
Drainage Area I	1.54	8.98

TACK ON BERM CHANNEL SIZING: BMP 1

Purpose:

Tack on berm channel to handle peak (25-yr/24-hr) stormwater flow.

Given:

1. Grassed V-ditch to handle runoff with 3:1 max slope on landfill
2. Bench channel height is 2-foot minimum
3. Average channel slope is 3.0%
4. TR-55 manual used to estimate peak flows
5. Maximum allowable length of sheet flow is 100 feet.

Assumptions:

1. Manning's number for grassed channel 0.033
2. Minimum 6-minute Time of Concentration per TR-55.
3. Runoff coefficient of 84 for grass side slopes using onsite soils. See attached soils map.
4. Used Knox County Tennessee Stormwater Management Manual Chapter 3 for Knox County rainfall intensity.
5. Design for 25-yr/24-hr storm, $i = 5.5$ inches.

Calculations:

Peak Flow – See attached output data from Peak Discharge Calculations.
Contributing Basin for Side Slope berm calculations is Drainage Area C.
For the 25-yr/24-hr storm (10.12 cfs), the flow depth is approximately 10.7 inches and the velocity is approximately 4.26 fps.

SIDE SLOPE STORMWATER PIPE SIZING: BMP 2a

Purpose:

Size stormwater pipe to handle peak (25-yr/24-hr) stormwater flow.

Given:

1. Single 18-inch diameter HPDE pipe to handle runoff
2. The pipe slope is approximately 31.5%

Assumptions:

1. Manning's number for corrugated HDPE pipe is 0.012
2. Minimum 6-minute Time of Concentration per TR-55.
3. Design for 25-yr/24-hr storm, $i = 5.5$ inches.

Calculations:

Peak Flow – See attached output data from Peak Discharge Calculations.
Contributing area for stormwater pipe calculation is 1.80 acres.
For the 25-yr/24-hr storm (10.49 cfs), the flow depth is approximately 15.4 inches and the velocity is approximately 6.7 fps.

SIDE SLOPE STORMWATER PIPES SIZING: BMP 2b

Purpose:

Size stormwater pipe handle peak (25-yr/24-hr) stormwater flow.

Given:

1. Two 18-inch diameter HPDE pipes to handle runoff
2. The pipe slope is approximately 35.4%

Assumptions:

1. Manning's number for corrugated HDPE pipe is 0.012
2. Minimum 6-minute Time of Concentration per TR-55.
3. Design for 25-yr/24-hr storm, $i = 5.5$ inches.

Calculations:

Peak Flow – See attached output data from Peak Discharge Calculations.

Contributing area for stormwater pipe calculation is 2.56 acres.

For the 25-yr/24-hr storm (15.19 cfs), the flow depth is approximately 12.8 inches and the velocity is approximately 5.7 fps.

ACCESS ROAD DITCH: BMP 3

Purpose:

Size ditch to handle peak (25-yr/24-hr) stormwater flow.

Given:

1. Ditch to handle runoff from Drainage Area D-1.
2. Length of the Ditch is approximately 396 feet.
3. Ditch slope is approximately 9.6%

Assumptions:

1. Manning's number for grassed channel 0.033
2. Minimum 6-minute Time of Concentration per TR-55.
3. Design for 25-yr/24-hr storm, $i = 5.5$ inches.

Calculations:

Peak Flow – See attached output data from Peak Discharge Calculations.

Contributing Area for the Access Road Ditch calculations is 1.07 acres.

For the 25-yr/24-hr storm (6.41 cfs), the flow depth is approximately 7.8 inches at the outfall and the velocity is approximately 6.1 fps.

SOUTH PERIMETER CHANNEL: BMP 4

Purpose:

Size perimeter channel to handle peak (25-yr/24-hr) stormwater flow.

Given:

1. Grassed Trapezoidal Channel to handle runoff with 3:1 max slope on landfill side and 3:1 max slope on road side.
2. Minimum of 12 inches of freeboard provided.
3. Average channel slope is 9.1%.
4. Channel length is approximately 500 feet.

Assumptions:

1. Manning's number for grassed channel 0.033
2. Minimum 6-minute Time of Concentration per TR-55.
3. Design for 25-yr/24-hr storm, $i = 5.5$ inches.

Calculations:

Peak Flow – See attached output data from Peak Discharge Calculations.

The contributing area for the South Perimeter Channel is 2.96 acres.

For the 25-yr/24-hr storm (17.43 cfs), the flow depth is approximately 4.7 inches at outfall and the velocity is approximately 6.2 fps.

SOUTHEAST PERIMETER CHANNEL: BMP 5

Purpose:

Size perimeter channel to handle peak (25-yr/24-hr) stormwater flow.

Given:

1. Lined Trapezoidal Channel to handle runoff with 3:1 max slope on landfill side and max slope on road side.
2. Minimum of 12 inches of freeboard provided.
3. Average channel slope is 9.83%.
4. Channel length is approximately 358 feet.

Assumptions:

1. Manning's number for lined channel 0.033
2. Minimum 6-minute Time of Concentration per TR-55.
3. Design for 25-yr/24-hr storm, $i = 5.5$ inches.

Calculations:

Peak Flow – See attached output data from Peak Discharge Calculations.

The contributing area for the Southeast Perimeter Channel calculations is 3.61 acres.

For the 25-yr/24-hr storm (21.2 cfs), the flow depth is approximately 5.0 inches and the velocity is approximately 6.95 fps.

PROPOSED 24 INCH STORMWATER PIPE: BMP 6

Purpose:

Confirm receiving culvert can handle peak (25-yr/24-hr) stormwater flow.

Given:

1. One 24 inch culvert to convey runoff from proposed CB-5 to proposed MH-4.
2. Length of the Culvert is 398 ft
3. Slope of Existing pipe is estimated to be approximately 9.3%

Assumptions:

1. Manning's number for existing CMP is 0.022
2. Minimum 6-minute Time of Concentration per TR-55.
3. Design for 25-yr/24-hr storm, $i = 5.5$ inches.

Calculations:

Peak Flow – See attached output data from Peak Discharge Calculations.
The contributing area to the existing 24 inch culvert calculations is 4.07 acres.
For the 25-yr/24-hr storm (23.73 cfs), the Highwater elevation at the inlet is 1103.5 feet.
This is approximately 1 feet below the roadway elevation. The maximum velocity is approximately 8.23 fps.

TWIN 24-INCH STORMWATER PIPES: BMP 7

Purpose:

Size culverts to handle peak (25-yr/24-hr) stormwater flow.

Given:

1. 2 – 24-inch diameter CMPs to handle runoff from the proposed drop inlet to Sediment Basin 3.
2. Length of the Culverts is approximately 62 feet.
3. Pipe slope is approximately 22.58%

Assumptions:

1. Manning's number for CMP channel 0.022
2. Minimum 6 minute Time of Concentration per TR-55.
3. Design for 25-yr/24-hr storm, $i = 5.5$ inches.

Calculations:

Peak Flow – See attached output data from Peak Discharge Calculations.
The contributing areas for the proposed culverts is 6.17 acres.
For the 25-yr/24-hr storm (36.14 cfs), the highwater elevation at the inlet is 1118.4 feet.
This is approximately 1.6 feet below the roadway elevation. The maximum velocity is estimated to be approximately 7.0 fps.

DROP INLET: BMP 8

Purpose:

Size grate inlet to handle peak (25-yr/24-hr) stormwater flow.

Given:

1. 2ft x 6ft Grate inlet to capture runoff from the East Perimeter Channel.
2. Contributing flow for Southeast Perimeter Channel is 22.0 cfs
3. Grate inlet is in a Sag

Assumptions:

1. Capacity of inlet is calculated using Equation 7-36 from the Knox County Stormwater management Manual
2. Inlet is operating as a weir
3. Design for 25-yr/24-hr storm, $i = 5.5$ inches.

Calculations:

Peak Flow – See attached output data from Peak Discharge Calculations.

The contributing area to Drop inlet is 21.2 cfs from the Southeast Perimeter Channel.

The flow depth is approximately 7.0 inches at the inlet.

SIDE SLOPE TERRACE: BMP 9

Purpose:

The side slope terrace is similar to the tack on berm channel but has been or is being constructed to manage run-off during operations rather than at part of closure maintenance to handle peak (25-yr/24-hr) stormwater flow.

Given:

1. Grassed V-ditch to handle runoff with 3:1 side slope and 8:1 side slope.
2. Depth of channel is 2-feet minimum.
3. Average channel slope is 4.2%
4. TR-55 manual used to estimate peak flows
5. Maximum allowable length of sheet flow is 100 feet.

Assumptions:

1. Manning's number for grassed channel 0.033
2. Minimum 6-minute Time of Concentration per TR-55.
3. Runoff coefficient of 84 for grass side slopes using onsite soils. See attached soils map.
4. Used Knox County Tennessee Stormwater Management Manual Chapter 3 for Knox County rainfall intensity.
5. Design for 25-yr/24-hr storm, $i = 5.5$ inches.

Calculations:

Peak Flow – See attached output data from Peak Discharge Calculations.

The contributing drainage area for Side Slope Terrace calculations is 0.61 acre from Drainage Area B-1. For the worst case scenario (3.56 cfs), the flow depth is approximately 5.4 inches and the velocity is approximately 3.2 fps.

NORTHEAST PERIMETER CHANNEL: BMP 10

Purpose:

Size perimeter channel to handle the peak (25-yr/24-hr) stormwater flow.

Given:

1. Triangular Channel to handle runoff with from landfill.
2. Minimum of 12 inches of freeboard provided.
3. Average channel slope is 9.09%.
4. Channel length is approximately 110 feet.

Assumptions:

1. Manning's number for grassed channel 0.033
2. Minimum 6-minute Time of Concentration per TR-55.
3. Design for 25-yr/24-hr storm, $i = 5.5$ inches.

Calculations:

Peak Flow – See attached output data from Peak Discharge Calculations.

The contributing area for the Northeast Perimeter Channel is 0.26 acres from Drainage Area G.

For the 25-yr/24-hr storm (1.52 cfs), the flow depth is approximately 4.3 inches and the velocity is approximately 3.9 fps.

SOUTH DOWN CHUTES: BMP 11

Purpose:

Size the proposed down chutes to handle the peak (25-yr/24-hr) stormwater flow.

Given:

1. Trapezoidal Channel to handle runoff with 2:1 side slopes and 6-ft bottom.
2. Depth of 12 inches.
3. Average channel slope is 28.4%.
4. Channel length is approximately 22 feet.

Assumptions:

1. Manning's number for lined channel 0.033
2. Minimum 6-minute Time of Concentration per TR-55.
3. Design for 25-yr/24-hr storm, $i = 5.5$ inches.

Calculations:

Peak Flow – See attached output data from Peak Discharge Calculations.

The maximum contributing area for the proposed lined down chute is 0.50 acres from Drainage Area D-1. For the worst case scenario (2.91 cfs), the flow depth is approximately 1.2 inches and the velocity is approximately 4.77 fps.

SEDIMENT BASIN 3: BMP 12

Purpose:

Size Sediment Basin 3 to contain the runoff volume from the (25-yr/24-hr) storm event.

Given:

1. Internal slopes of the sediment basin are 2:1
2. The emergency overflow elevation is at 1108.

Assumptions:

1. Minimum 6-minute Time of Concentration per TR-55.
2. Design for 25-yr/24-hr storm, $i = 5.5$ inches.

Calculations:

The contributing area for the SB-3 storage volume is approximately 7.51 acres and the required storage volume is approximately 3,735 CY. The Design storage volume between elevation 1100 and 1107 is 3,768 CY.

SOUTHWEST CHANNEL: BMP 13

Purpose:

Size perimeter channel to handle the peak (25-yr/24-hr) stormwater flow.

Given:

1. Trapezoidal Channel to handle runoff with from landfill.
2. Minimum of 12 inches of freeboard provided.
3. Average channel slope is 2.3%.

Assumptions:

1. Manning's number for grassed channel 0.033
2. Minimum 6-minute Time of Concentration per TR-55.
3. Design for 25-yr/24-hr storm, $i = 5.5$ inches.

Calculations:

Peak Flow – See attached output data from Peak Discharge Calculations.

The contributing area is 1.54 acres (Drainage Area I).

For the 25-yr/24-hr storm (8.98 cfs), the flow depth is approximately 5.2 inches and the velocity is approximately 3.3 fps.

CONCLUSIONS

The stormwater hydraulic analysis was conducted using AutoCAD Hydraflow and the Knox County Tennessee Stormwater Management Manual. The results summarized in the calculations section of each BMP can be found in Hydraflow Channel Reports – BMP Calculations (**Attachment 3**). Based on the flow depths and velocities, the following conclusions are provided for each BMP.

BMP 1 – The side slope berms provide adequate depth to contain the 25-yr/24-hr storm and typically flow at velocities below 5 fps. However Section 2 of Tack on Berm 1 has flow velocities slightly greater than 5 fps. To maintain the integrity of the cover vegetation erosion control matting is required for the last 300 feet of Tack on Berm 1.

BMP 2a – The proposed 18-inch diameter corrugated HDPE pipe will convey runoff from the 25-yr/24-hr storm. The peak outfall depth and velocity do not require additional energy dissipation and standard inlet and outfall structures will be adequate.

BMP 2b – The proposed twin 18-inch diameter corrugated HDPE pipes will convey runoff from the 25-yr/24-hr storm. The peak outfall depth and velocity do not require additional energy dissipation and standard inlet and outfall structures will be adequate.

BMP 3 – The Access Road Ditch will convey runoff from the 25-yr/24-hr storm at a velocity of approximately 6.1 fps. Erosion control matting will be required to maintain the integrity of the cover vegetation.

BMP 4 – The proposed South Perimeter Channel of the proposed C&D expansion will convey runoff from the 25-yr/24-hr storm at a depth of approximately 4.7 inches and a velocity of approximately 6.2 fps. Erosion control blanket will be required to maintain the integrity of the channel.

BMP 5 – The proposed Southeast Perimeter Channel of the proposed C&D expansion will convey runoff from the 25-yr/24-hr storm at a depth of approximately 5 inches and a velocity of approximately 6.95 fps. Erosion control blanket will be required to maintain the integrity of the channel.

BMP 6 – The proposed 24-inch diameter CMP to the proposed MH-4 will convey runoff from the 25-yr/24-hr storm. The peak flow depth and velocity do not require additional capacity and standard inlet and outfall structures will be adequate.

BMP 7 – The proposed (2) 24-inch diameter CMPs to Sediment Basin 3 will convey runoff from the 25-yr/24-hr storm. The peak outfall depth and velocity do not require additional energy dissipation and standard inlet and outfall structures will be adequate.

BMP 8 – The proposed drop inlet CMPs will convey runoff from the 25-yr/24-hr storm. The grate inlet will be placed in a Sag position to prevent by-pass flow and standard stormwater management practices shall be implemented to ensure the inlet is maintained.

BMP 9 – The proposed side slope terrace is currently being constructed on the northeast slope as was proposed in the current permit. The terrace will convey runoff from the 25-yr/24-hr storm at a depth of approximately 6.7 inches and a velocity of 3.78 fps.

BMP 10 – The proposed Northeast Perimeter Channel will convey runoff from the 25-yr/24-hr storm at a depth of approximately 4.32 inches with a velocity of approximately 3.91 fps.

BMP 11 – The proposed South Down Chutes will convey runoff from TB-3 and TB-4 at a depth of approximately 1.2 inches with a velocity of approximately 4.7 fps.

BMP 12 – Sediment Basin 3 will receive runoff from approximate 7.5 acres on and around Phase F-2 an increase of approximately 2.5 acres from the previous design. The design of SB-3 has been expanded to capture the additional flow from the 25-yr/24-hr storm event.

The principal spillway will be a 36-inch diameter riser and 30-inch diameter barrel. The emergency spillway will be an 18-foot wide grass-lined channel.

BMP 13 – The proposed Southwest Channel will convey runoff from the 25-yr/24-hr storm at a depth of approximately 5.2 inches with a velocity of approximately 3.32 fps.

REFERENCE 1



design storm event over 24-hours with a 1% chance of occurring in any given year is often referred to as the 100-year, 24-hour storm. This design storm would be developed based on assumptions regarding intensity and distribution of the storm over the specified timeframe (24-hours for this scenario). Therefore, a design storm event is used to estimate actual storm events even though it would be very unlikely that an actual storm event would match up with all of the design storm event assumptions.

Rainfall intensities for Knox County are provided in Table 3-4 and should be used for all hydrologic analysis. The sources of the values in this table are the Weather Bureau Technical Papers TP-25 and TP-40 (Hershfield, 1961) and National Weather Service publication Hydro-35 (NOAA, 1977). The intensity values have been adjusted to produce smooth intensity-duration-frequency (IDF) curves and cumulative rainfall distributions. Table 3-5 shows the rainfall depths for hypothetical storm events.

Figure 3-1 shows the IDF curves for Knox County for the 1, 2, 5, 10, 25, and 100-year, 24-hour storms. These curves are plots of the tabular values. No values are given for times less than 5 minutes.

Table 3-4. Intensity-Duration-Frequency Curve Data

(Sources: Hershfield, 1961; NOAA, 1977)

ARI ¹ (years)		24-Hour Precipitation Frequency Estimates (inches/hour) by Return Periods					
Hours	Minutes	2-year	5-year	10-year	25-year	50-year	100-year
0.083	5	4.60	5.55	6.25	7.30	7.90	8.60
0.170	10	3.70	4.60	5.25	6.20	6.80	7.49
0.250	15	3.19	3.98	4.60	5.45	6.00	6.60
0.330	20	2.82	3.50	4.10	4.90	5.45	6.02
0.420	25	2.48	3.12	3.70	4.45	4.95	5.50
0.500	30	2.22	2.80	3.34	4.03	4.53	5.03
0.580	35	2.02	2.55	3.06	3.67	4.14	4.62
0.670	40	1.86	2.35	2.82	3.38	3.80	4.24
0.750	45	1.73	2.18	2.62	3.14	3.53	3.93
0.830	50	1.62	2.04	2.46	2.94	3.30	3.67
0.920	55	1.53	1.92	2.32	2.77	3.10	3.45
1.000	60	1.45	1.82	2.20	2.62	2.93	3.26
1.500	90	1.06	1.36	1.64	1.95	2.18	2.45
2.000	120	0.86	1.09	1.31	1.55	1.71	1.95
3.000	180	0.66	0.80	0.97	1.13	1.23	1.38
6.000	360	0.41	0.50	0.58	0.66	0.75	0.83
12.000	720	0.24	0.30	0.34	0.39	0.43	0.48
24.000	1440	0.14	0.17	0.20	0.23	0.25	0.27

1 - ARI= Average Recurrence Interval

Table 3-5. Rainfall Depths for Hypothetical Storm Events

Storm Event	24-Hr Depth (in)
1-year	2.5
2-year	3.3
5-year	4.1
10-year	4.8
25-year	5.5
100-year	6.5

ATTACHMENT 1

Peak Discharge Calculations

MAJOR BASINS - TIME OF CONCENTRATION (TOC) CALCULATIONS

		Drainage Areas 1-3	Drainage Areas 4-5								
CN		84	85								
S		1.905	1.905								
Frequency (yr)		25	25								
Rainfall, P (in)		5.5	5.5								
P ₂ (in)		3.3	3.3								
Runoff, Q (in)		3.731	3.731								
Drainage Area (ac)	Flow Type	Length (ft)	Slope (ft/ft)	Surface (Manning's n)	Average Velocity (ft/s)	Area (ft ²)	Wp (ft)	r (ft)	V (ft/s)	Tt (hr)	Tc (hr)
Drainage Area A-1 0.39 ac	Sheet	61	0.3300	0.240						0.051	
	Shallow Concentrated										
	Channel	278	0.0432	0.033		0.50	2.59	0.19	3.135	0.025	
	Channel	125	0.1998	0.033		0.50	2.59	0.19	6.777	0.005	
	Channel	376	0.0266	0.033		3.00	6.32	0.47	4.481	0.023	
	Channel	269	0.0297	0.033		3.00	6.32	0.47	4.735	0.016	
											0.12
Drainage Area A-2 1.17 ac	Sheet	80	0.3000	0.240						0.066	
	Shallow Concentrated										
	Channel	397	0.1058	0.033		3.00	6.32	0.47	8.936	0.012	
											0.08
Drainage Area A-3 0.24 ac	Sheet	100	0.2800	0.240						0.081	
	Shallow Concentrated	14	0.2800	Unpaved TR-55 Figure 3-1	9.000					0.000	
	Channel	786	0.0392	0.033		3.00	6.32	0.47	5.440	0.040	
											0.12
Drainage Area B-1 0.61 ac	Sheet	28	0.0714	0.240						0.051	
	Shallow Concentrated										
	Channel	84	0.0952	0.033		0.84	3.13	0.27	5.796	0.004	
	Channel	313	0.0894	0.033		0.84	3.13	0.27	5.617	0.015	
	Channel	714	0.0762	0.033		3.00	8.66	0.35	6.148	0.032	
											0.10
Drainage Area B-2 0.26 ac	Sheet	97	0.1443	0.240						0.104	
	Shallow Concentrated	148	0.2162	Unpaved TR-55 Figure 3-1	7.500					0.005	
	Channel	203	0.1084	0.072		5.12	10.11	0.51	4.328	0.013	
											0.12
Drainage Area C 1.69 ac	Sheet	100	0.4300	0.240						0.069	
	Shallow Concentrated	60	0.4300	Unpaved TR-55 Figure 3-1	9.000					0.002	
	Channel										0.07
Drainage Area D-1 1.07 ac	Sheet	100	0.4300	0.240						0.069	
	Shallow Concentrated	60	0.4300	Unpaved TR-55 Figure 3-1	9.000					0.002	
	Channel										0.07
Drainage Area D-2 0.50 ac	Sheet	100	0.4300	0.240						0.069	
	Shallow Concentrated	60	0.4300	Unpaved TR-55 Figure 3-1	9.000					0.002	
	Channel										

											0.07
Drainage Area D-3 0.52 ac	Sheet	100	0.4300	0.240						0.069	
	Shallow Concentrated	60	0.4300	Unpaved TR-55 Figure 3-1	9.000					0.002	
	Channel										
											0.07
Drainage Area D-4 0.28 ac	Sheet	100	0.4300	0.240						0.069	
	Shallow Concentrated	60	0.4300	Unpaved TR-55 Figure 3-1	9.000					0.002	
	Channel										
											0.07
Drainage Area D-5 0.59 ac	Sheet	100	0.4300	0.240						0.069	
	Shallow Concentrated	60	0.4300	Unpaved TR-55 Figure 3-1	9.000					0.002	
	Channel										
											0.07
Drainage Area E 0.65 ac	Sheet	100	0.4300	0.240						0.069	
	Shallow Concentrated	60	0.4300	Unpaved TR-55 Figure 3-1	9.000					0.002	
	Channel										
											0.07
Drainage Area F 2.27 ac	Sheet	100	0.4300	0.240						0.069	
	Shallow Concentrated	60	0.4300	Unpaved TR-55 Figure 3-1	9.000					0.002	
	Channel										
											0.07
Drainage Area G 0.26 ac	Sheet	100	0.4300	0.240						0.069	
	Shallow Concentrated	60	0.4300	Unpaved TR-55 Figure 3-1	9.000					0.002	
	Channel										
											0.07
Drainage Area H 1.08 ac	Sheet	100	0.4300	0.240						0.069	
	Shallow Concentrated	60	0.4300	Unpaved TR-55 Figure 3-1	9.000					0.002	
	Channel										
											0.07
Drainage Area I 1.54 ac	Sheet	100	0.4300	0.240						0.069	
	Shallow Concentrated	60	0.4300	Unpaved TR-55 Figure 3-1	9.000					0.002	
	Channel										
											0.07

Notes:

1. A CN value of 84 was used based on pasture or range land, soil group D average of poor and good
*Knox County Stormwater Manual
2. A 2' deep triangular channel w/3:1 slopes was used to estimate tack on Berm channel areas.
3. Total Area 10.79 acres

SUB-BASIN TIME OF CONCENTRATION (TOC) CALCULATIONS

	25yr		100 yr		5 yr							
	Tack On Berms	Access Road	Tack On Berms	Access Road	Tack On Berms	Access Road						
CN	84	85	84	85	84	85						
S	1.905	1.765	1.905	1.765	1.905	1.765						
Frequency (yr)	25	25	100	100	5	5						
Rainfall, P (in)	5.5	5.5	6.5	6.5	4.1	4.1						
P ₂ (in)	3.3	3.3	3.3	3.3	3.3	3.3						
Runoff, Q (in)	3.731	3.833	4.666	4.776	2.459	2.547						
Drainage Area (ac)	Flow Type	Length (ft)	Slope (ft/ft)	Surface (Manning's n)	Average Velocity (ft/s)	Area (ft ²)	Wp (ft)	r (ft)	V (ft/s)	Tt (hr)	Tc (hr)	
Sub Drainage Area 1 Flows 1-3 0.575 ac	Sheet	61	0.3300	0.240						0.051		
	Shallow Concentrated											
	Channel	278	0.0432	0.033		0.50	2.59	0.19	3.135	0.025		
	Channel	125	0.1998	0.033		0.50	2.59	0.19	6.741	0.005		
											0.081	
Sub Drainage Area 4 Sections 1-3 0.83 ac	Sheet	28	0.0714	0.240						0.051		
	Shallow Concentrated											
	Channel	84	0.0952	0.033		0.84	3.13	0.27	5.796	0.004		
	Channel	313	0.0894	0.033		0.84	3.13	0.27	5.617	0.015		
											0.070	

Note: Sub-Drainage Areas are Sub-Basins of the Major Drainage Basins and the areas do not accumulate to a larger Drainage Area.

PEAK DISCHARGE CALCULATIONS (25YR/24HR)

Drainage Area Name	Drainage Area (ac.)	Drainage Area (sq.mi.)	CN	Tc (hr)	Rainfall Dist.	Pond/Swamp Area	Frequency (yr)	Rainfall (P) (in)	Initial Abs. (Ia) (in)	Ia/P	Peak Disch. (qu) ³ (csm/in)	Runoff (Q) (in)	Peak Discharge (ft ³ /sec.)
A-1	0.39	0.001	84	0.10	II	1.00	25	3.3	0.381	0.115	1000	3.731	2.27
A-2	1.17	0.002	84	0.10	II	1.00	25	5.5	0.381	0.069	1000	3.731	6.82
A-3	0.24	0.000	84	0.10	II	1.00	25	5.5	0.381	0.069	1000	3.731	1.40
B-1	0.61	0.001	84	0.10	II	1.00	25	5.5	0.381	0.069	1000	3.731	3.56
B-2	0.26	0.000	84	0.10	II	1.00	25	5.5	0.381	0.069	1000	3.731	1.52
C	1.69	0.003	84	0.10	II	1.00	25	5.5	0.353	0.064	1000	3.833	10.12
D-1	1.07	0.002	85	0.10	II	1.00	25	5.5	0.353	0.064	1000	3.833	6.41
D-2	0.50	0.001	84	0.10	II	1.00	25	5.5	0.381	0.069	1000	3.731	2.91
D-3	0.52	0.001	85	0.10	II	1.00	25	5.5	0.381	0.069	1000	3.731	3.03
D-4	0.28	0.000	84	0.10	II	1.00	25	5.5	0.381	0.069	1000	3.731	1.63
D-5	0.59	0.001	85	0.10	II	1.00	25	5.5	0.381	0.069	1000	3.731	3.44
E	0.65	0.001	85	0.10	II	1.00	25	5.5	0.381	0.069	1000	3.731	3.79
F	2.27	0.004	84	0.10	II	1.00	25	5.5	0.381	0.069	1000	3.731	13.23
G	0.26	0.000	85	0.10	II	1.00	25	5.5	0.381	0.069	1000	3.731	1.52
H	1.08	0.002	85	0.10	II	1.00	25	5.5	0.381	0.069	1000	3.731	6.30
I	1.54	0.002	84	0.10	II	1.00	25	5.5	0.381	0.069	1000	3.731	8.98
Total	11.58												

Tack On Berm - BMP 1	10.12
18-Inch Down Chute BMP 2a	10.49
2 - 18-Inch Down Chutes BMP 2b	15.19
Access Road Ditch BMP 3	6.41
South Perimeter Channel BMP 4	17.43
Southeast Perimeter Channel BMP 5	21.22
Proposed 24-Inch Culvert BMP 6	23.73
Proposed 24-Inch Culverts BMP 7	36.41
Proposed Drop Inlet BMP 8	21.22
Proposed Side Slope Terrace BMP 9	3.56
Northeast Perimeter Channel BMP 10	1.52
South Down Chute - BMP 11	2.91
Sedimentation Basin 3 BMP 12	44.22
Southwest Swale Spreader	8.98

7.51
1.54

NOTES:

1. 6 minutes used for all times of concentration therefore the Peak discharge of 1000 was used for all calculations of Q. This Peak Discharge provides for higher more conservative flow rates.

PEAK DISCHARGE CALCULATIONS (100YR/24HR)

Drainage Area Name	Drainage Area (ac.)	Drainage Area (sq.mi.)	CN	Tc (hr)	Rainfall Dist.	Pond/Swamp Area	Frequency (yr)	Rainfall (P) (in)	Initial Abs. (Ia) (in)	Ia/P	Peak Disch. (qu) ³ (csm/in)	Runoff (Q) (in)	Peak Discharge (ft ³ /sec.)
A-1	0.39	0.001	84	0.12	II	1.00	100	6.5	0.381	0.059	1000	4.666	2.84
A-2	1.17	0.002	84	0.10	II	1.00	100	6.5	0.381	0.059	1000	4.666	8.53
A-3	0.24	0.000	84	0.10	II	1.00	100	6.5	0.381	0.059	1000	4.666	1.75
B-1	0.61	0.001	84	0.10	II	1.00	100	6.5	0.381	0.059	1000	4.666	4.45
B-2	0.26	0.000	84	0.12	II	1.00	100	6.5	0.381	0.059	1000	4.666	1.90
C	1.69	0.003	84	0.10	II	1.00	100	6.5	0.381	0.059	1000	4.776	12.61
D-1	1.07	0.002	85	0.12	II	1.00	100	6.5	0.353	0.054	1000	4.776	7.98
D-2	0.50	0.001	84	0.10	II	1.00	100	6.5	0.381	0.059	1000	4.666	3.65
D-3	0.52	0.001	85	0.10	II	1.00	100	6.5	0.353	0.054	1000	4.666	3.79
D-4	0.28	0.000	84	0.10	II	1.00	100	6.5	0.381	0.059	1000	4.666	2.04
D-5	0.59	0.001	85	0.10	II	1.00	100	6.5	0.353	0.054	1000	4.666	4.30
E	0.65	0.001	85	0.10	II	1.00	100	6.5	0.353	0.054	1000	4.666	4.74
F	2.27	0.004	84	0.10	II	1.00	100	6.5	0.381	0.059	1000	4.666	16.55
G	0.26	0.000	85	0.10	II	1.00	100	6.5	0.353	0.054	1000	4.666	1.90
H	1.08	0.002	84	0.10	II	1.00	100	6.5	0.381	0.059	1000	4.666	7.87
Total	11.58												

Tack On Berm - BMP 1	12.61
18-Inch Down Chute BMP 2a	13.12
2 - 18-Inch Down Chutes BMP 2b	18.95
Access Road Ditch BMP 3	7.98
South Perimeter Channel BMP 4	21.76
Southeast Perimeter Channel BMP 5	26.50
Proposed 24-Inch Culvert BMP 6	31.57
Proposed 24-Inch Culverts BMP 7	45.46
Proposed Drop Inlet BMP 8	45.46
Proposed Side Slope Terrace BMP 9	4.45
Northeast Perimeter Channel BMP 10	1.90
South Down Chute - BMP 11	3.65
Sedimentation Basin 3 BMP 12	55.23

NOTES:

1. 6 minutes used for all times of concentration therefore the Peak discharge of 1000 was used for all calculations of Q. This Peak Discharge provides for higher more conservative flow rates.

ATTACHMENT 2
Drainage Area Map

LEGEND	
—	BASIN DELINEATION LINE
- - -	SUB-BASIN DELINEATION LINE
- - -	PROPERTY LINE
→	FLOW ARROW
- - -	PROPOSED TACK ON BERMS

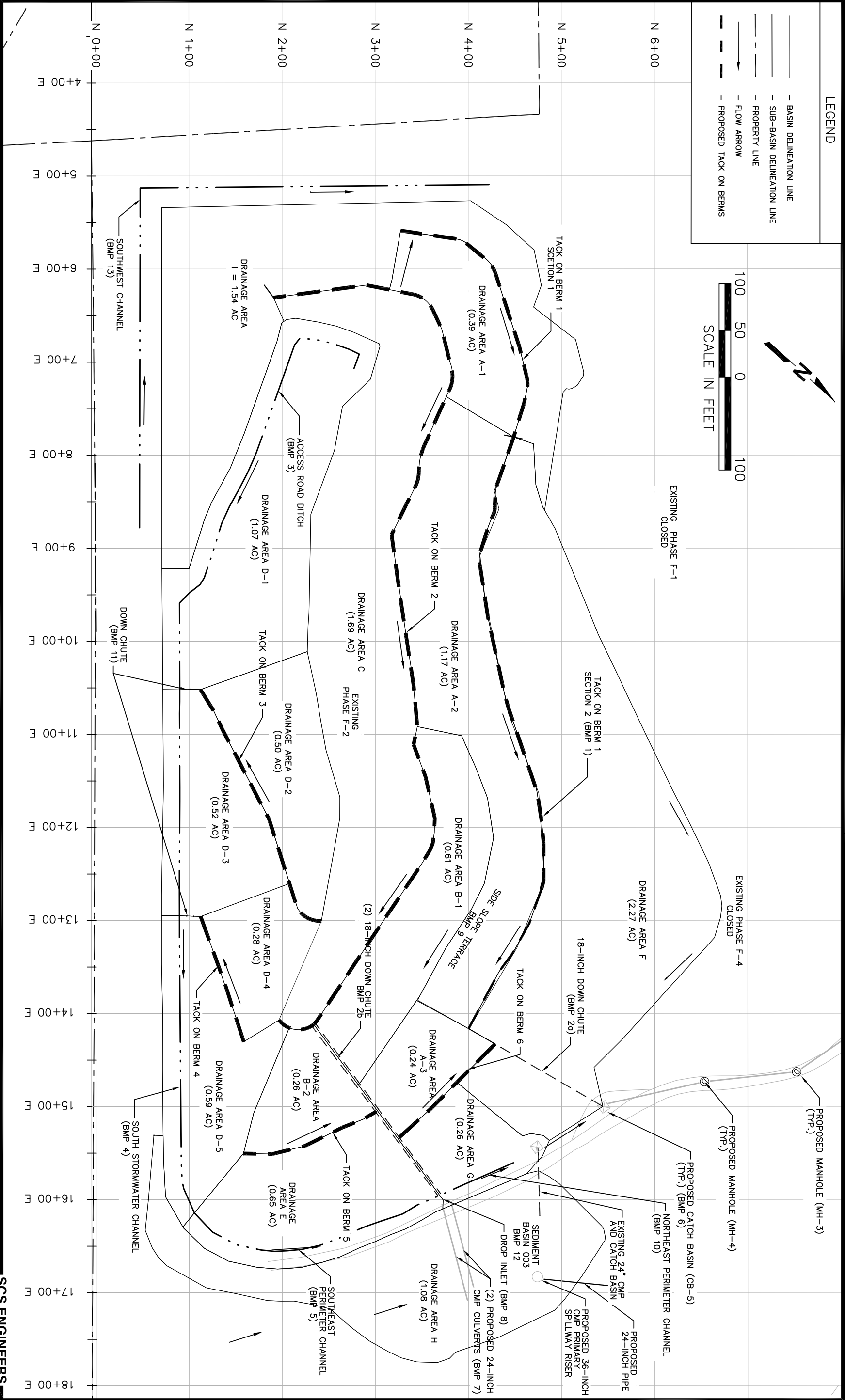
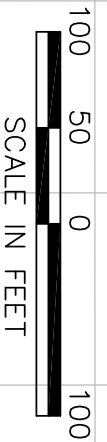

YARNELL ROAD LANDFILL PHASE F-2 DRAINAGE AREA DELINEATION MAP

ATTACHMENT 3

Hydraflow Reports – BMP Calculations

Channel Report

BMP 1 - Tack-On Berm

Triangular

Side Slopes (z:1) = 3.00, 3.00

Total Depth (ft) = 2.00

Invert Elev (ft) = 1.00

Slope (%) = 3.00

N-Value = 0.033

Calculations

Compute by: Known Q

Known Q (cfs) = 10.12

Highlighted

Depth (ft) = 0.89

Q (cfs) = 10.12

Area (sqft) = 2.38

Velocity (ft/s) = 4.26

Wetted Perim (ft) = 5.63

Crit Depth, Y_c (ft) = 0.94

Top Width (ft) = 5.34

EGL (ft) = 1.17

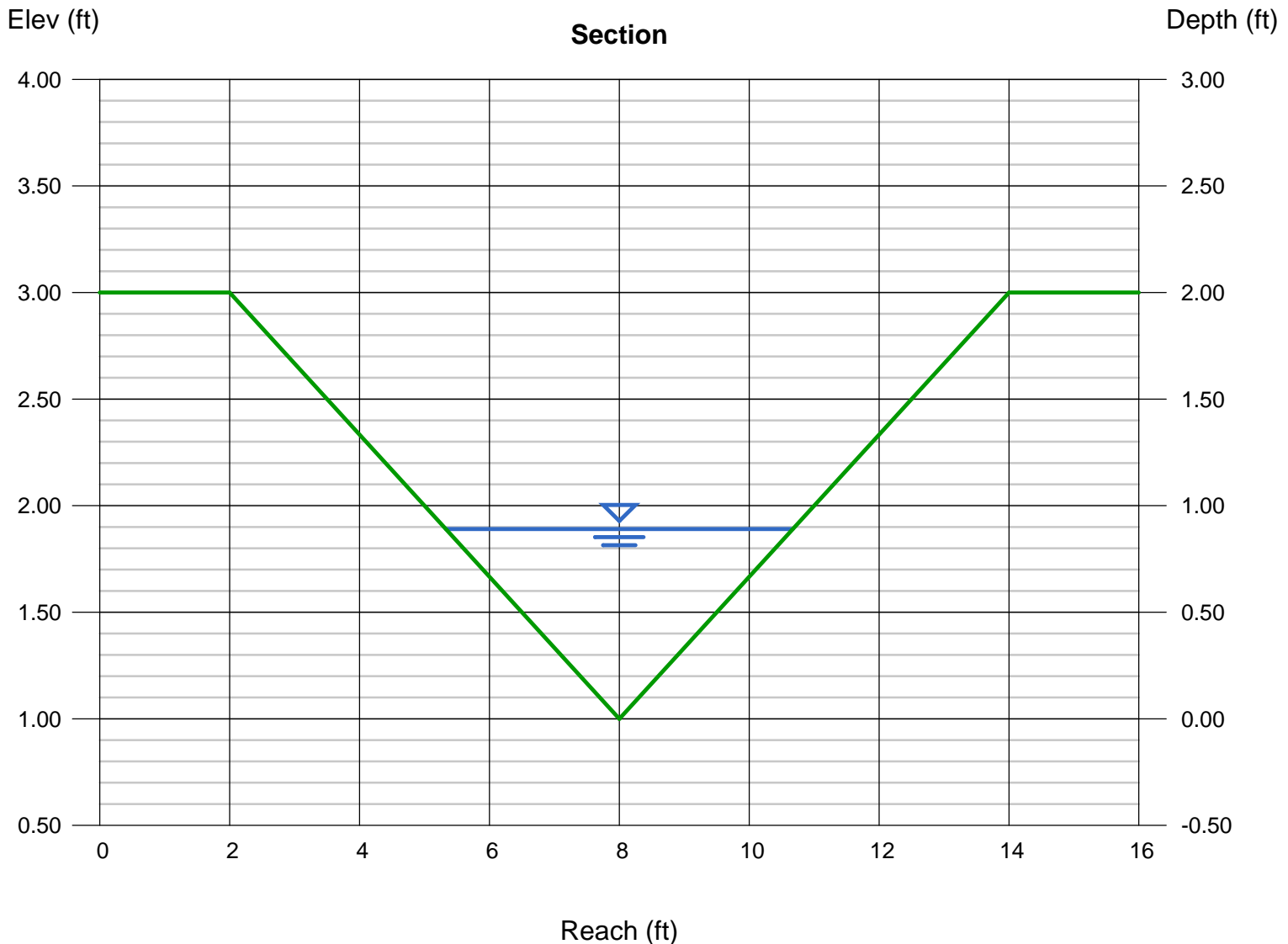

Channel Report

BMP 1 - Tack-On Berm 1 (Velocity)

Triangular

Side Slopes (z:1) = 3.00, 3.00

Total Depth (ft) = 2.00

Invert Elev (ft) = 1.00

Slope (%) = 5.00

N-Value = 0.033

Calculations

Compute by: Known Q

Known Q (cfs) = 9.09

Highlighted

Depth (ft) = 0.77

Q (cfs) = 9.090

Area (sqft) = 1.78

Velocity (ft/s) = 5.11

Wetted Perim (ft) = 4.87

Crit Depth, Yc (ft) = 0.90

Top Width (ft) = 4.62

EGL (ft) = 1.18

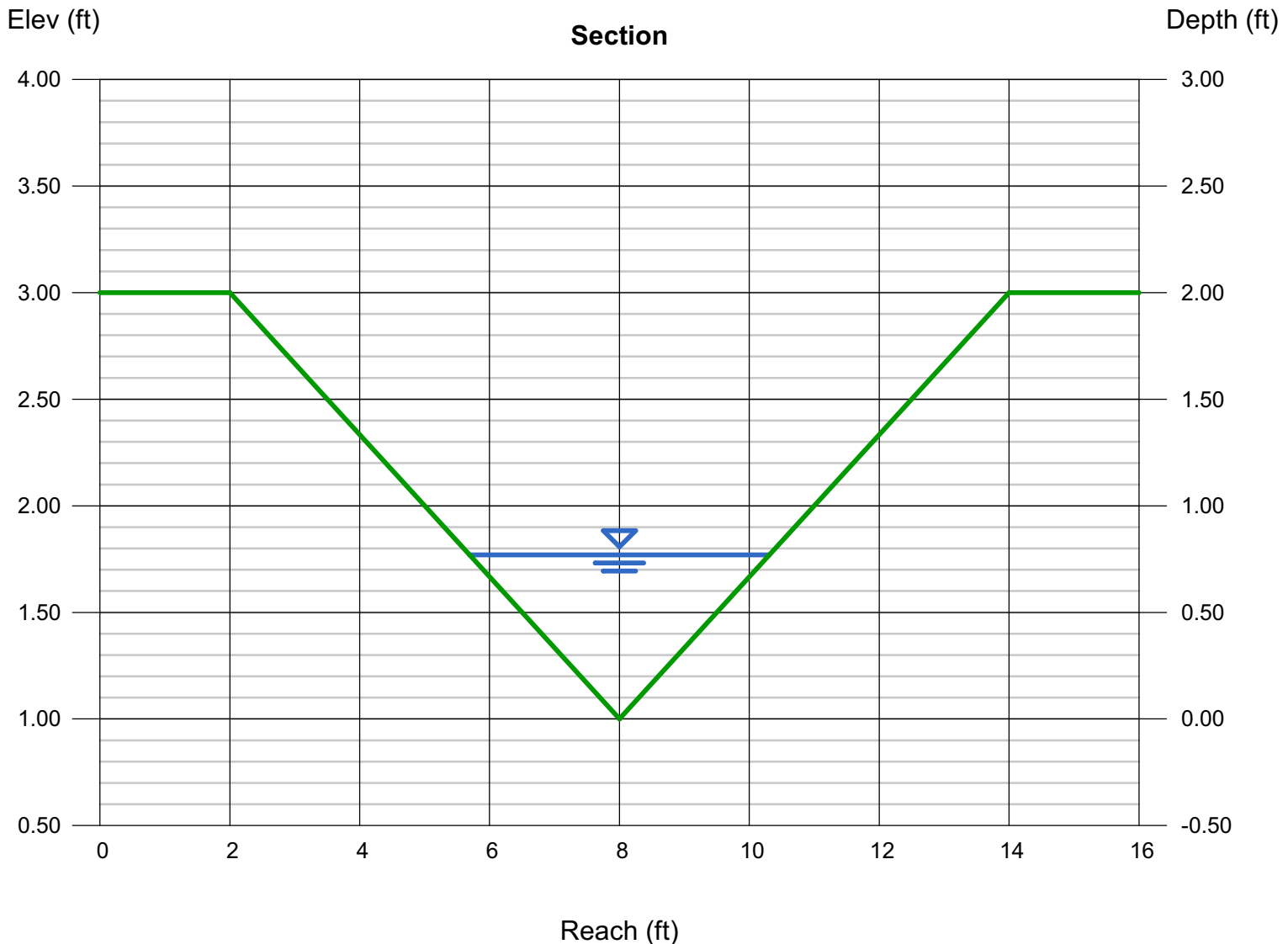



ROLLMAX™
ROLLED EROSION CONTROL

Specification Sheet – EroNet™ P300® Permanent Erosion Control Blanket

DESCRIPTION

The permanent erosion control blanket shall be a machine-produced mat of 100% UV stable polypropylene fiber. The matting shall be of consistent thickness with the synthetic fibers evenly distributed over the entire area of the mat. The matting shall be covered on the top side with black heavyweight UV-stabilized polypropylene netting having ultraviolet additives to delay breakdown and an approximate 0.50 x 0.50 inch (1.27 x 1.27 cm) mesh. The bottom net shall also be UV-stabilized polypropylene with a 0.63 x 0.63 inch (1.57 x 1.57 cm) mesh size. The blanket shall be sewn together on 1.5 inch (3.81 cm) centers with non-degradable thread. All mats shall be manufactured with a colored thread stitched along both outer edges as an overlap guide for adjacent mats. The P300 shall meet Type 5A, 5B, specification requirements established by the Erosion Control Technology Council (ECTC) and Federal Highway Administration's (FHWA) FP-03 Section 713.18

Material Content

Matrix	100% UV stable Polypropylene Fiber	0.7 lbs/sq yd (0.38 kg/sm)
	Top: UV-stabilized Polypropylene	5 lbs/1000 sq ft (24.4 g/sm)
Netting	Bottom: UV-stabilized Polypropylene	3 lbs/1000 sq ft (14.7 g/sm)
Thread	Polypropylene, UV stable	

Standard Roll Sizes

Width	6.5 ft (2.0 m)	8 ft (2.44 m)
Length	108 ft (32.92 m)	112 ft (35.14 m)
Weight ± 10%	61 lbs (27.66 kg)	76.25 lbs (34.59 kg)
Area	80 sq yd (66.0 sm)	100 sq yd (83.61 sm)

Slope Design Data: C Factors

Slope Gradients (S)

Slope Length (L)	≤ 3:1	3:1 – 2:1	≥ 2:1
≤ 20 ft (6 m)	0.001	0.029	0.082
20-50 ft	0.036	0.060	0.086
≥ 50 ft (15.2 m)	0.070	0.090	0.110

Index Property	Test Method	Typical
Thickness	ASTM D6525	0.47 in. (11.94 mm)
Resiliency	ASTM D6524	91.5%
Density	ASTM D792	0.916 g/cm ³
Mass/Unit Area	ASTM 6566	13.03 oz/sy (443 g/m ²)
UV Stability	ASTM D4355/1000 hr	90%
Porosity	ECTC Guidelines	95.89%
Stiffness	ASTM D1388	0.94 in-lb (1085378 mg-cm)
Light Penetration	ASTM D6567	17.9%
Tensile Strength - MD	ASTM D6818	438 lbs/ft (6.49 kN/m)
Elongation - MD	ASTM D6818	28.1%
Tensile Strength - TD	ASTM D6818	291.9 lbs/ft (4.32 kN/m)
Elongation - TD	ASTM D6818	26.7%
Biomass Improvement	ASTM D7322	497%

Design Permissible Shear Stress

	Short Duration	Long Duration
Phase 1: Unvegetated	3.0 psf (144 Pa)	2.0 psf (96 Pa)
Phase 2: Partially Veg.	8.0 psf (383 Pa)	8.0 psf (383 Pa)
Phase 3: Fully Veg.	8.0 psf (383 Pa)	8.0 PSF (383 Pa)
Unvegetated Velocity	9.0 fps (2.7 m/s)	
Vegetated Velocity	16 fps (4.9 m/s)	

Roughness Coefficients – Unveg.

Flow Depth	Manning's n
≤ 0.50 ft (0.15 m)	0.034
0.50 – 2.0 ft	0.034-0.020
≥ 2.0 ft (0.60 m)	0.020



North American Green
5401 St. Wendel-Cynthiana Road
Poseyville, Indiana 47633

nagreen.com
800-772-2040

©2017, North American Green is a registered trademark. Certain products and/or applications described or illustrated herein are protected under one or more U.S. patents. Other U.S. patents are pending, and certain foreign patents and patent applications may also exist. Trademark rights also apply as indicated herein. Final determination of the suitability of any information or material for the use contemplated, and its manner of use, is the sole responsibility of the user. Printed in the U.S.A.

Culvert Report

BMP 2A - 18-Inch Down Chute

Invert Elev Dn (ft)	=	1106.00
Pipe Length (ft)	=	162.00
Slope (%)	=	31.50
Invert Elev Up (ft)	=	1157.03
Rise (in)	=	18.0
Shape	=	Circular
Span (in)	=	18.0
No. Barrels	=	1
n-Value	=	0.012
Culvert Type	=	Circular Culvert
Culvert Entrance	=	Smooth tapered inlet throat
Coeff. K,M,c,Y,k	=	0.534, 0.555, 0.0196, 0.9, 0.2

Embankment

Top Elevation (ft)	=	1160.00
Top Width (ft)	=	0.50
Crest Width (ft)	=	0.00

Calculations

Qmin (cfs)	=	0.00
Qmax (cfs)	=	10.49
Tailwater Elev (ft)	=	(dc+D)/2

Highlighted

Qtotal (cfs)	=	10.49
Qpipe (cfs)	=	10.49
Qovertop (cfs)	=	0.00
Veloc Dn (ft/s)	=	6.19
Veloc Up (ft/s)	=	6.70
HGL Dn (ft)	=	1107.37
HGL Up (ft)	=	1158.27
Hw Elev (ft)	=	1158.95
Hw/D (ft)	=	1.28
Flow Regime	=	Inlet Control

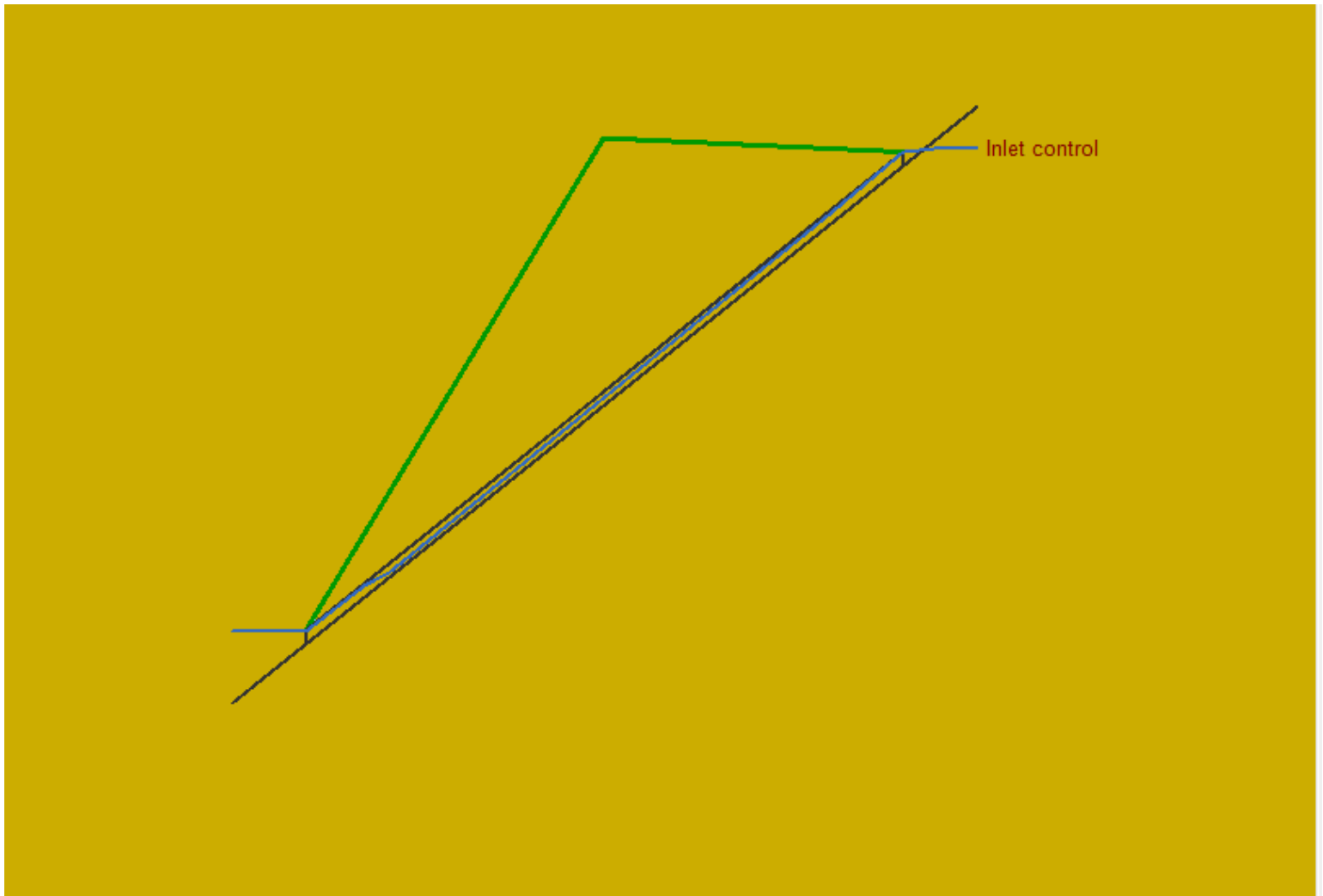

Culvert Report

BMP 2b - 18-Inch Down Chute

Invert Elev Dn (ft)	=	1116.00
Pipe Length (ft)	=	226.00
Slope (%)	=	35.40
Invert Elev Up (ft)	=	1196.00
Rise (in)	=	18.0
Shape	=	Circular
Span (in)	=	18.0
No. Barrels	=	2
n-Value	=	0.012
Culvert Type	=	Circular Culvert
Culvert Entrance	=	Smooth tapered inlet throat
Coeff. K,M,c,Y,k	=	0.534, 0.555, 0.0196, 0.9, 0.2

Embankment	
Top Elevation (ft)	= 1199.00
Top Width (ft)	= 0.50
Crest Width (ft)	= 0.00

Calculations	
Qmin (cfs)	= 0.00
Qmax (cfs)	= 15.19
Tailwater Elev (ft)	= (dc+D)/2

Highlighted	
Qtotal (cfs)	= 15.19
Qpipe (cfs)	= 15.19
Qovertop (cfs)	= 0.00
Veloc Dn (ft/s)	= 4.72
Veloc Up (ft/s)	= 5.65
HGL Dn (ft)	= 1117.28
HGL Up (ft)	= 1197.07
Hw Elev (ft)	= 1197.61
Hw/D (ft)	= 1.07
Flow Regime	= Inlet Control

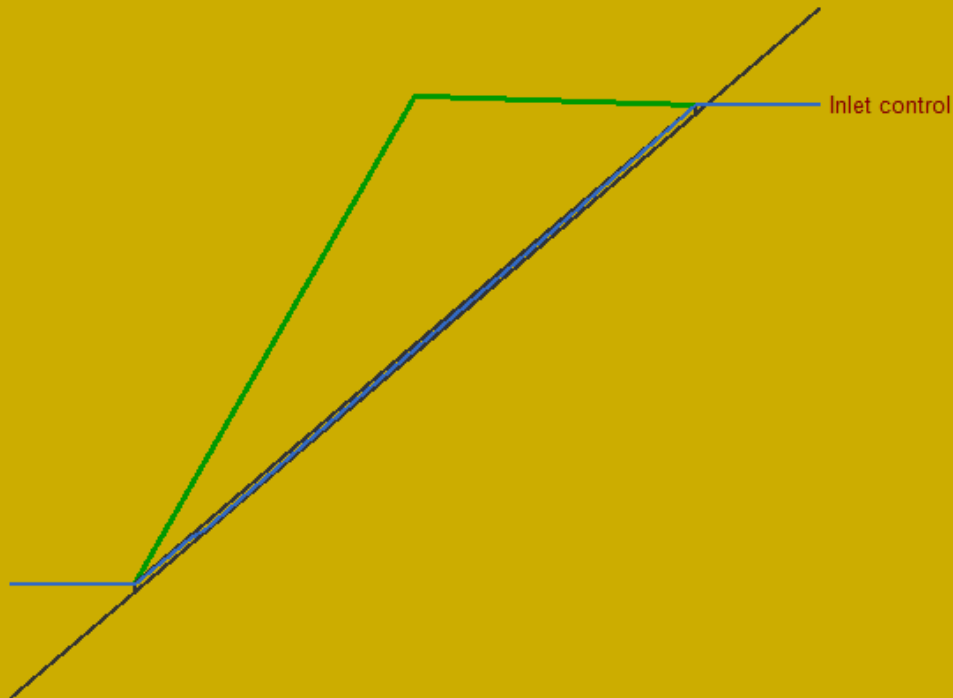

Channel Report

BMP 3 - Access Road Ditch

Triangular

Side Slopes (z:1) = 2.00, 3.00

Total Depth (ft) = 2.00

Invert Elev (ft) = 1.00

Slope (%) = 9.60

N-Value = 0.033

Calculations

Compute by: Known Q

Known Q (cfs) = 6.41

Highlighted

Depth (ft) = 0.65

Q (cfs) = 6.410

Area (sqft) = 1.06

Velocity (ft/s) = 6.07

Wetted Perim (ft) = 3.51

Crit Depth, Yc (ft) = 0.84

Top Width (ft) = 3.25

EGL (ft) = 1.22

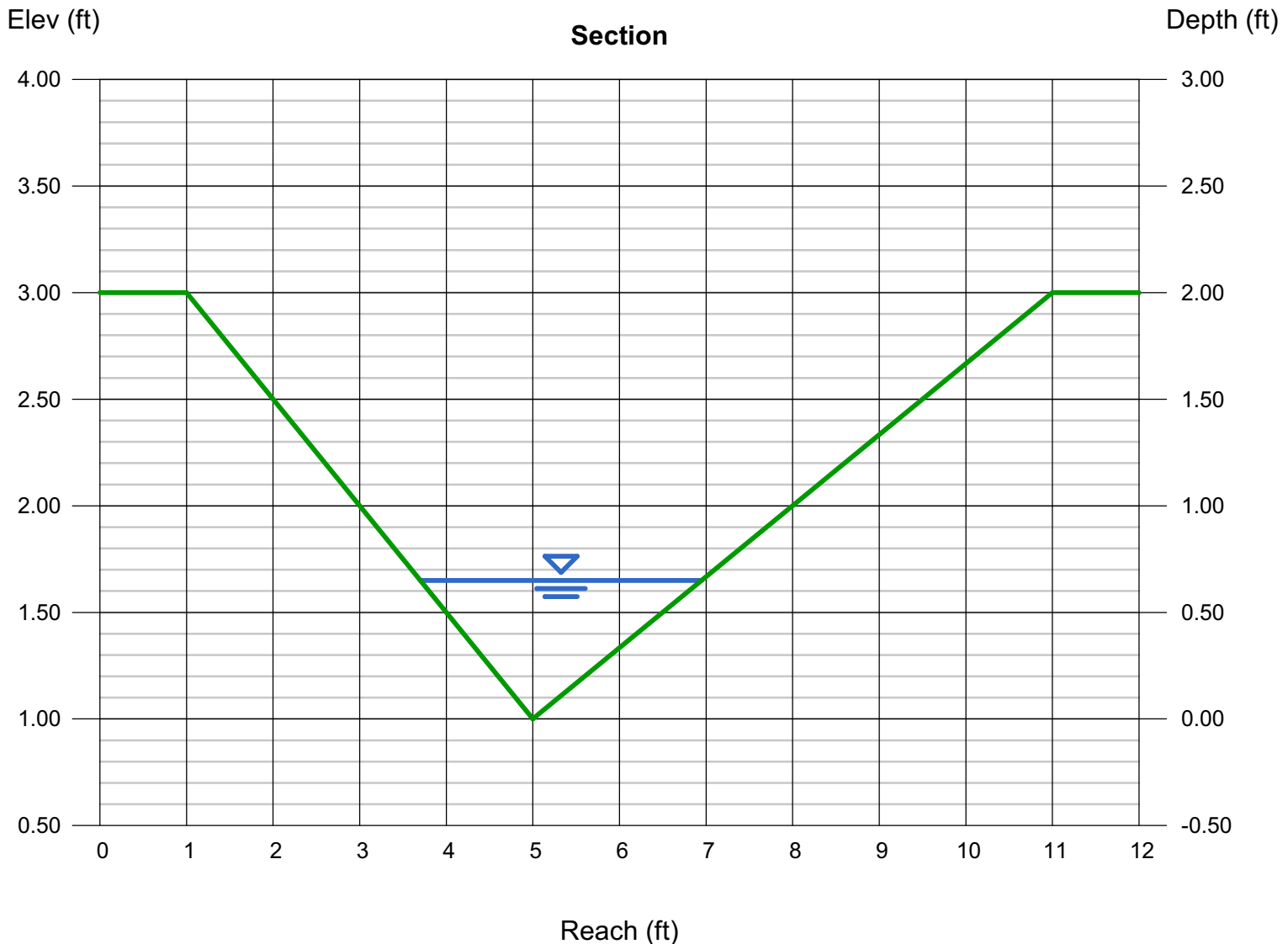

Channel Report

BMP 4 - South Perimeter Channel

Trapezoidal

Bottom Width (ft) = 6.00
Side Slopes (z:1) = 3.00, 3.00
Total Depth (ft) = 2.00
Invert Elev (ft) = 1.00
Slope (%) = 9.10
N-Value = 0.033

Highlighted

Depth (ft) = 0.39
Q (cfs) = 17.43
Area (sqft) = 2.80
Velocity (ft/s) = 6.23
Wetted Perim (ft) = 8.47
Crit Depth, Yc (ft) = 0.58
Top Width (ft) = 8.34
EGL (ft) = 0.99

Calculations

Compute by: Known Q
Known Q (cfs) = 17.43

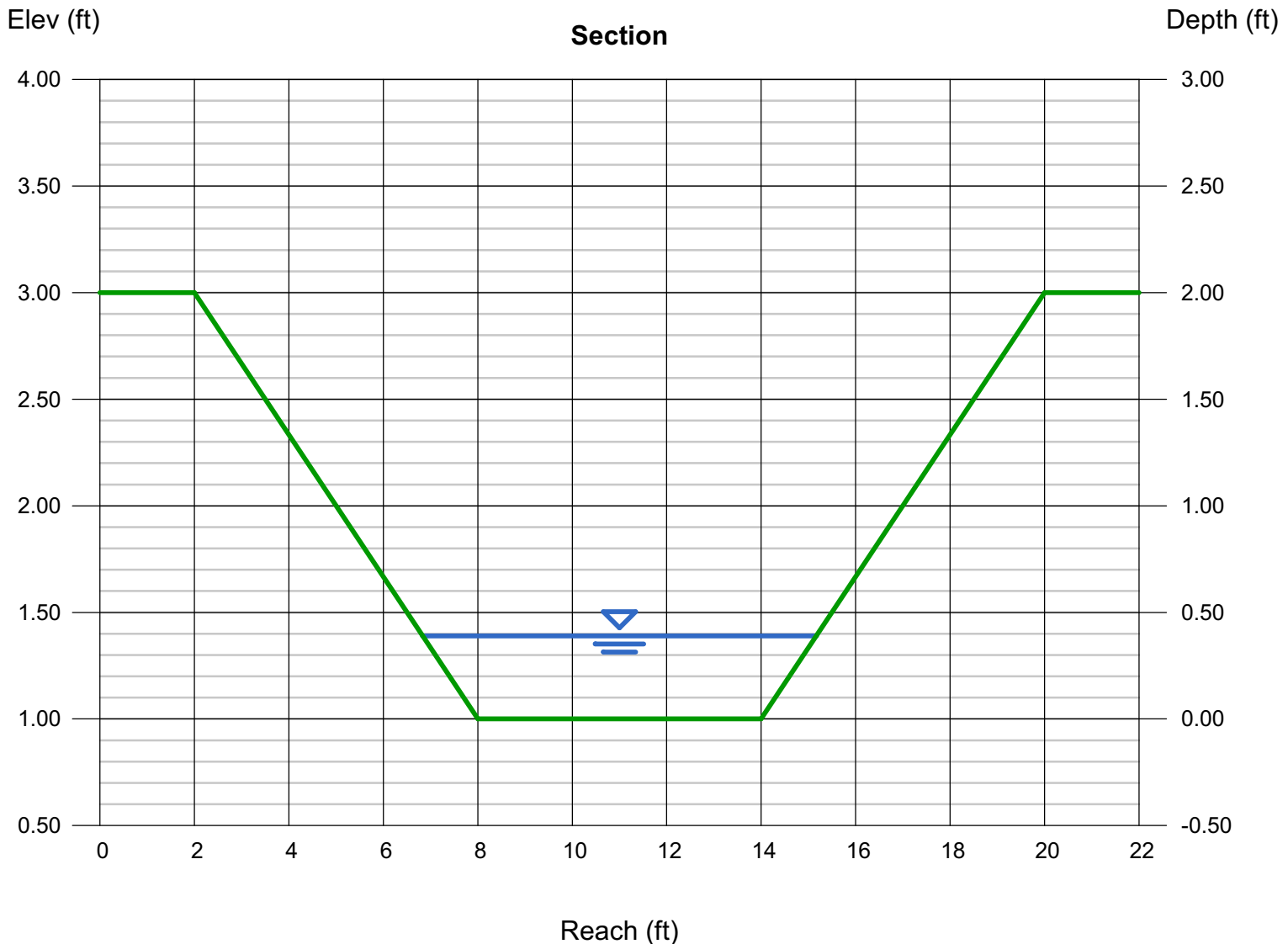

Channel Report

BMP 5 - Southeast Perimeter Channel

Trapezoidal

Bottom Width (ft) = 6.00
Side Slopes (z:1) = 3.00, 3.00
Total Depth (ft) = 2.00
Invert Elev (ft) = 1.00
Slope (%) = 9.83
N-Value = 0.033

Highlighted

Depth (ft) = 0.42
Q (cfs) = 21.20
Area (sqft) = 3.05
Velocity (ft/s) = 6.95
Wetted Perim (ft) = 8.66
Crit Depth, Yc (ft) = 0.66
Top Width (ft) = 8.52
EGL (ft) = 1.17

Calculations

Compute by: Known Q
Known Q (cfs) = 21.20

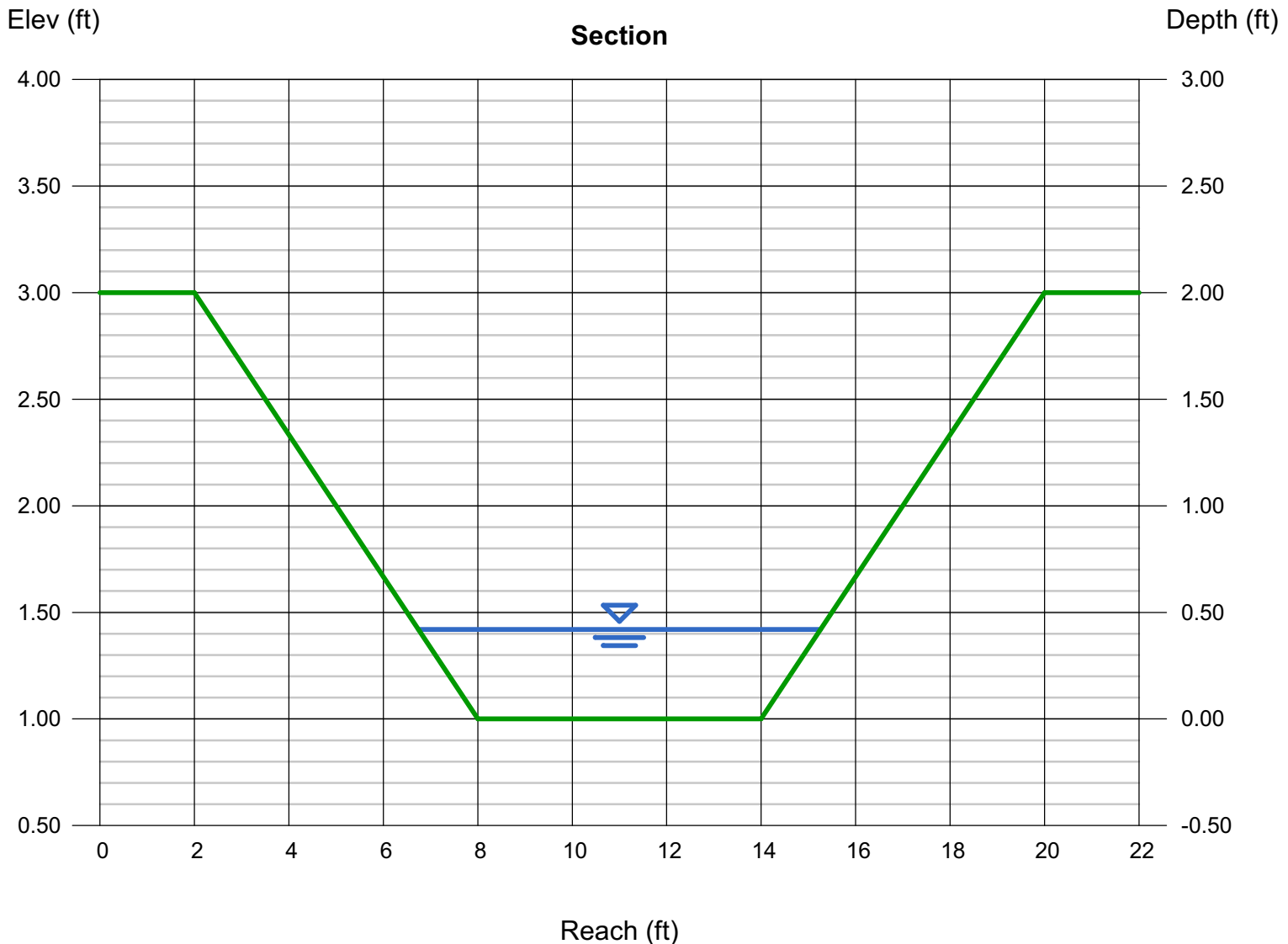

Culvert Report

BMP 6 - Proposed 24 Inch CMP - CB-5 to MH-4

Invert Elev Dn (ft)	=	1063.00
Pipe Length (ft)	=	398.00
Slope (%)	=	9.30
Invert Elev Up (ft)	=	1100.01
Rise (in)	=	24.0
Shape	=	Circular
Span (in)	=	24.0
No. Barrels	=	1
n-Value	=	0.022
Culvert Type	=	Circular Corrugate Metal Pipe
Culvert Entrance	=	Headwall
Coeff. K,M,c,Y,k	=	0.0078, 2, 0.0379, 0.69, 0.5

Embankment	
Top Elevation (ft)	= 1110.00
Top Width (ft)	= 20.00
Crest Width (ft)	= 0.00

Calculations	
Qmin (cfs)	= 0.00
Qmax (cfs)	= 25.24
Tailwater Elev (ft)	= (dc+D)/2

Highlighted	
Qtotal (cfs)	= 25.24
Qpipe (cfs)	= 25.24
Qovertop (cfs)	= 0.00
Veloc Dn (ft/s)	= 8.23
Veloc Up (ft/s)	= 8.59
HGL Dn (ft)	= 1064.88
HGL Up (ft)	= 1101.78
Hw Elev (ft)	= 1103.74
Hw/D (ft)	= 1.87
Flow Regime	= Inlet Control

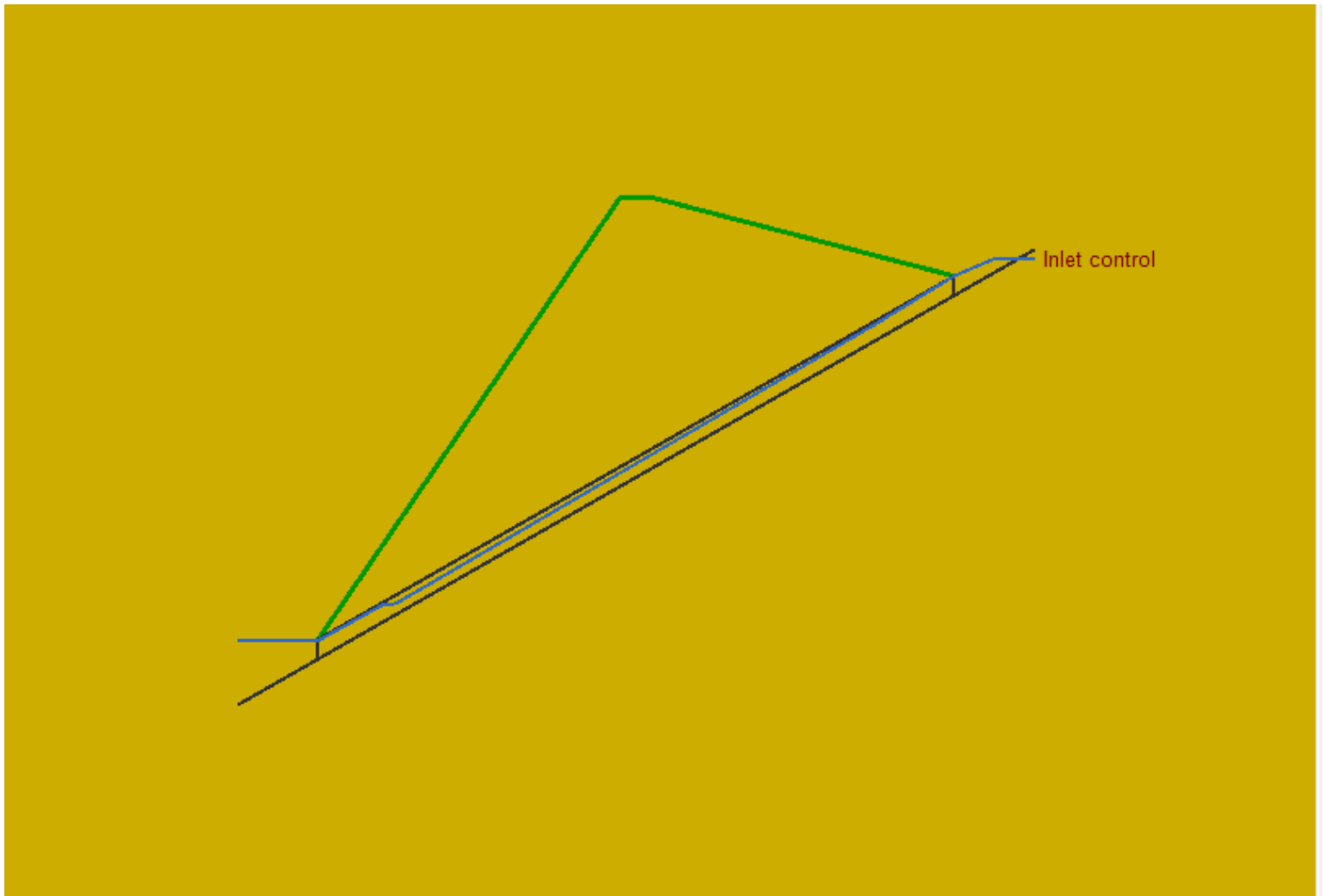

Culvert Report

BMP 7 - Proposed 24 Inch Culverts

Invert Elev Dn (ft)	=	1102.00
Pipe Length (ft)	=	62.00
Slope (%)	=	22.58
Invert Elev Up (ft)	=	1116.00
Rise (in)	=	24.0
Shape	=	Circular
Span (in)	=	24.0
No. Barrels	=	2
n-Value	=	0.022
Culvert Type	=	Circular Corrugate Metal Pipe
Culvert Entrance	=	Headwall
Coeff. K,M,c,Y,k	=	0.0078, 2, 0.0379, 0.69, 0.5

Embankment

Top Elevation (ft)	=	1120.00
Top Width (ft)	=	20.00
Crest Width (ft)	=	0.00

Calculations

Qmin (cfs)	=	0.00
Qmax (cfs)	=	36.41
Tailwater Elev (ft)	=	(dc+D)/2

Highlighted

Qtotal (cfs)	=	36.41
Qpipe (cfs)	=	36.41
Qovertop (cfs)	=	0.00
Veloc Dn (ft/s)	=	6.20
Veloc Up (ft/s)	=	7.03
HGL Dn (ft)	=	1103.77
HGL Up (ft)	=	1117.54
Hw Elev (ft)	=	1118.43
Hw/D (ft)	=	1.21
Flow Regime	=	Inlet Control

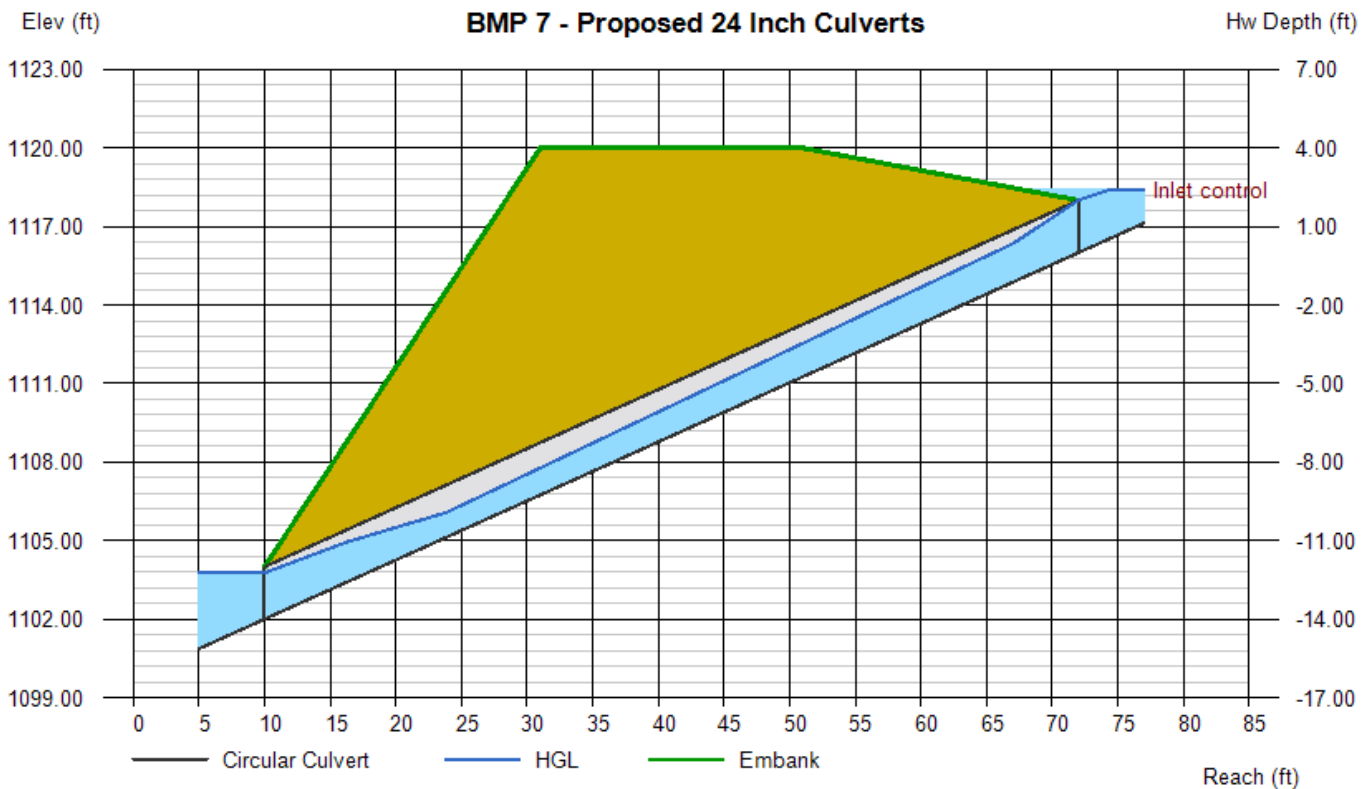

BMP 8 - Proposed Drop Inlet

Per Knox County Tennessee Stormwater Management Manual

For an Inlet operating as a weir use Equation 7-36

$$\text{Equation 7-36 } Q_i = 3.0 P d^{1.5}$$

where: Q_i = the capacity of the grate inlet = 21.22 cfs

min. P Proposed = 6ft x 2ft grate = 16ft perimeter

d = Depth

$$Q = 3.0 P d^{1.5}$$

$$21.22 = 3.0 (16^{ft}) d^{1.5}$$

$$\frac{21.22 \text{ cfs}}{3.0 (16^{ft})} = d^{1.5}$$

$$0.442^{2/3} = d$$

$$0.580 = d = 6.96 \text{ inches}$$

The proposed 6ft x 2ft grate inlet produces

less than 1ft of Freeboard in the proposed

2ft deep ditch.

Equation 7-35
$$Q_i = EQ = Q[R_f E_o + R_s (1 - E_o)]$$

Example 7-19. Composite Gutter Flow Calculation

Given: W = 2 ft
 T = 8 ft
 $S_x = 0.025$ ft/ft S = 0.01 ft/ft
 $E_o = 0.69$ Q = 3.0 cfs
 V = 3.1 ft/s Gutter depression = 2 in

Find: Interception capacity of: (1) a curved vane grate; and, (2) a 2ft by 2ft reticuline grate

Solution: From Figure 7-44 for Curved Vane Grate, $R_f = 1.0$
 From Figure 7-44 for Curved Vane Grate, $R_f = 1.0$
 From Figure 7-44 for Reticuline Grate, $R_f = 1.0$
 From Figure 7-45 $R_s = 0.1$ for both grates
 From Equation 7-35:

$$Q_i = EQ = Q [R_f E_o + R_s (1 - E_o)] = 3.0[(1.0)(0.69) + 0.1(1 - 0.69)] = 2.2 \text{ cfs}$$

For this example, the interception capacity of a curved vane grate is the same as that for a reticuline grate for the sited conditions.

7.6.5.2 Grate Inlets in a Sag

A grate inlet in a sag operates as a weir up to a certain depth, depending on the bar configuration and size of the grate, and as an orifice at greater depths. For a standard gutter inlet grate, weir operation continues to a depth of about 0.4 feet above the top of grate and when depth of water exceeds about 1.4 feet, the grate begins to operate as an orifice. Between depths of about 0.4 feet and about 1.4 feet, a transition from weir to orifice flow occurs.

The capacity of grate inlets operating as a weir is calculated using Equation 7-36.

Equation 7-36
$$Q_i = 3.0Pd^{1.5}$$

where:

Q_i = the capacity of the grate inlet
 P = perimeter of grate excluding bar widths and the side against the curb, ft
 d = depth of water above grate, ft

The capacity of grate inlets operating as an orifice is calculated using Equation 7-37.

Equation 7-37
$$Q_i = CA(2gd)^{0.5}$$

where:

Q_i = the capacity of the grate inlet
 C = 0.67 orifice coefficient
 A = clear opening area of the grate, ft²
 g = 32.2 ft/s²
 d = depth of water above grate, ft

Figure 7-46 is a plot of Equations 7-36 and 7-37 for various grate sizes. The effects of grate size on the depth at which a grate operates as an orifice is apparent from the chart. Transition from weir to orifice flow results in interception capacity less than that computed by either weir or the

Channel Report

BMP 9 - Proposed Side Slope Terrace

Triangular

Side Slopes (z:1) = 3.00, 8.00

Total Depth (ft) = 2.00

Invert Elev (ft) = 1.00

Slope (%) = 4.23

N-Value = 0.033

Calculations

Compute by: Known Q

Known Q (cfs) = 3.56

Highlighted

Depth (ft) = 0.45

Q (cfs) = 3.560

Area (sqft) = 1.11

Velocity (ft/s) = 3.20

Wetted Perim (ft) = 5.05

Crit Depth, Yc (ft) = 0.49

Top Width (ft) = 4.95

EGL (ft) = 0.61

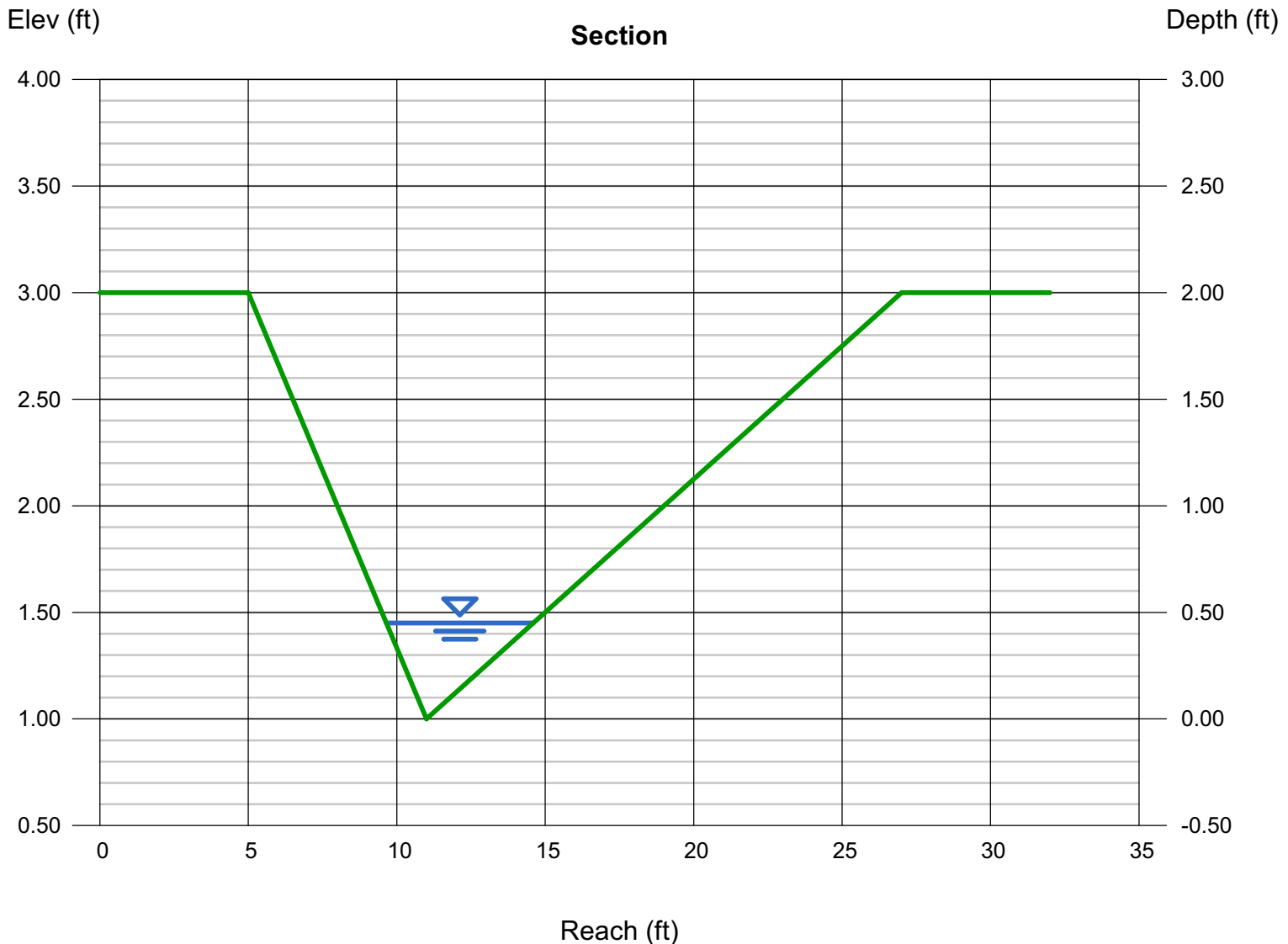

Channel Report

BMP 10 - Northeast Perimeter Channel

Triangular

Side Slopes (z:1) = 3.00, 3.00

Total Depth (ft) = 2.00

Invert Elev (ft) = 1110.00

Slope (%) = 9.09

N-Value = 0.033

Calculations

Compute by: Known Q

Known Q (cfs) = 1.52

Highlighted

Depth (ft) = 0.36

Q (cfs) = 1.520

Area (sqft) = 0.39

Velocity (ft/s) = 3.91

Wetted Perim (ft) = 2.28

Crit Depth, Yc (ft) = 0.44

Top Width (ft) = 2.16

EGL (ft) = 0.60

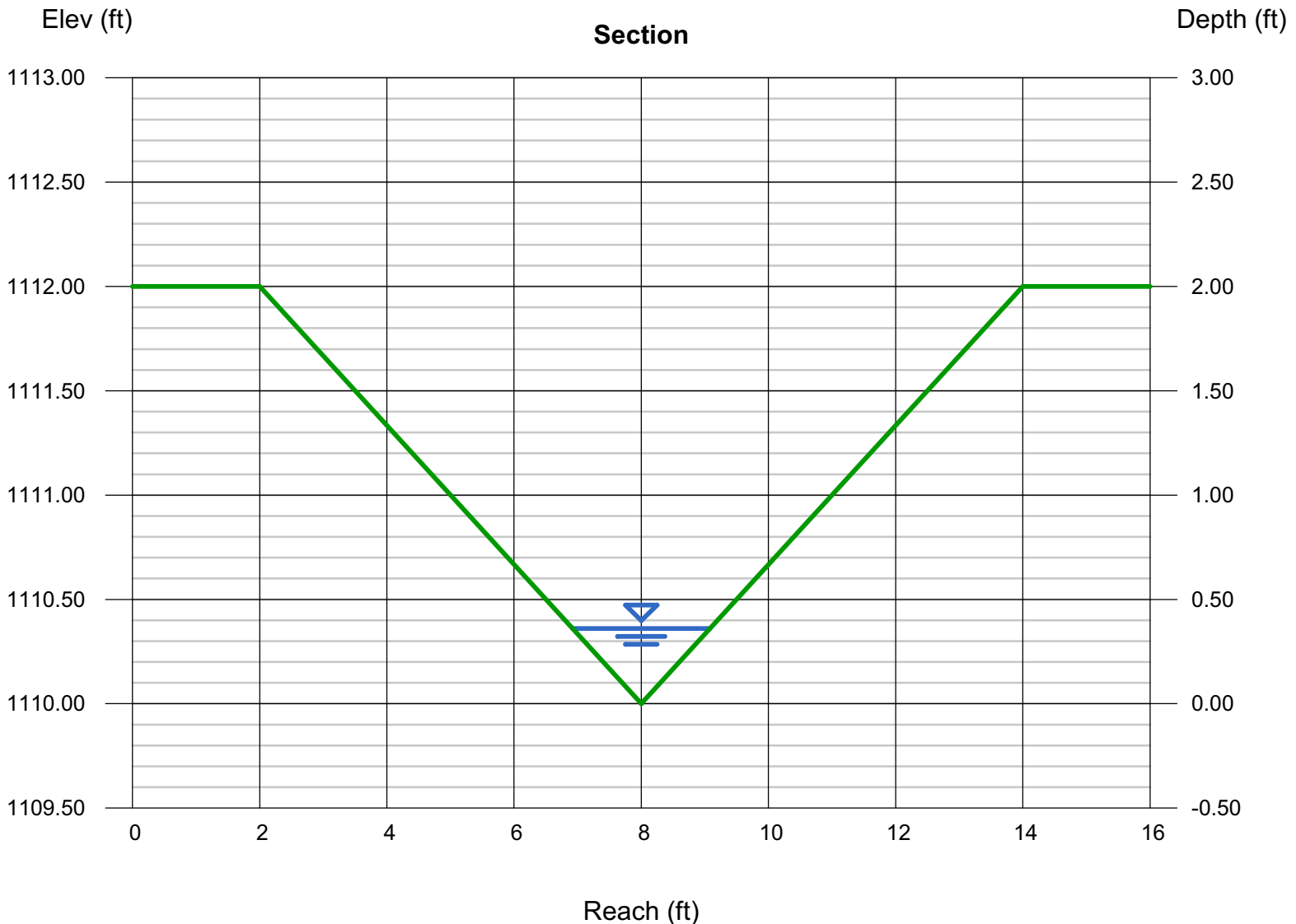

Channel Report

BMP 11 - South Down Chutes

Trapezoidal

Bottom Width (ft) = 6.00
Side Slopes (z:1) = 2.00, 2.00
Total Depth (ft) = 1.00
Invert Elev (ft) = 1199.75
Slope (%) = 28.40
N-Value = 0.033

Highlighted

Depth (ft) = 0.10
Q (cfs) = 2.910
Area (sqft) = 0.62
Velocity (ft/s) = 4.69
Wetted Perim (ft) = 6.45
Crit Depth, Y_c (ft) = 0.19
Top Width (ft) = 6.40
EGL (ft) = 0.44

Calculations

Compute by: Known Q
Known Q (cfs) = 2.91

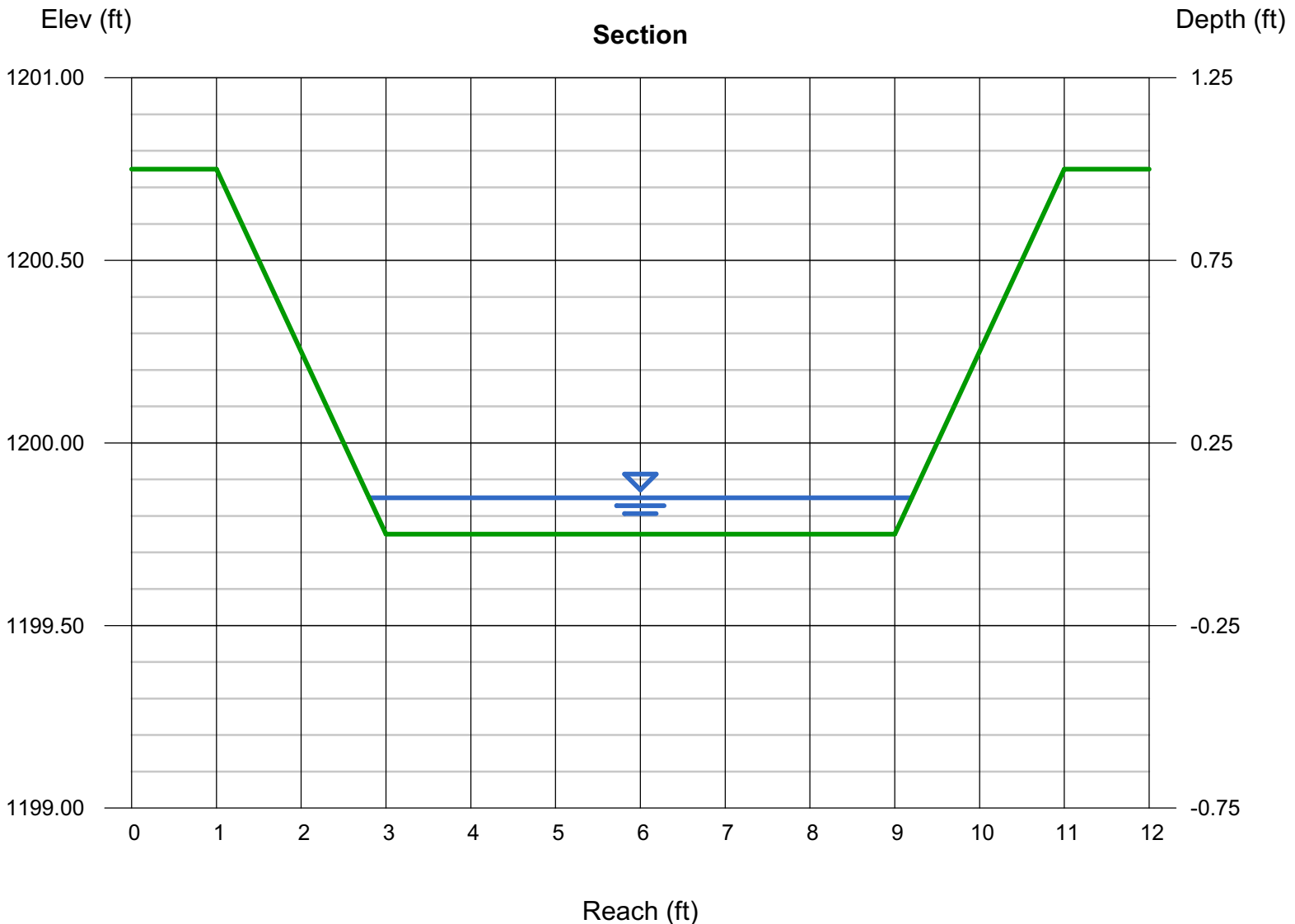

Channel Report

BMP 13 - Southwest Spreader Swale

Trapezoidal

Bottom Width (ft) = 5.00
Side Slopes (z:1) = 3.00, 3.00
Total Depth (ft) = 2.00
Invert Elev (ft) = 1.00
Slope (%) = 2.30
N-Value = 0.033

Highlighted

Depth (ft) = 0.43
Q (cfs) = 8.980
Area (sqft) = 2.70
Velocity (ft/s) = 3.32
Wetted Perim (ft) = 7.72
Crit Depth, Yc (ft) = 0.43
Top Width (ft) = 7.58
EGL (ft) = 0.60

Calculations

Compute by: Known Q
Known Q (cfs) = 8.98

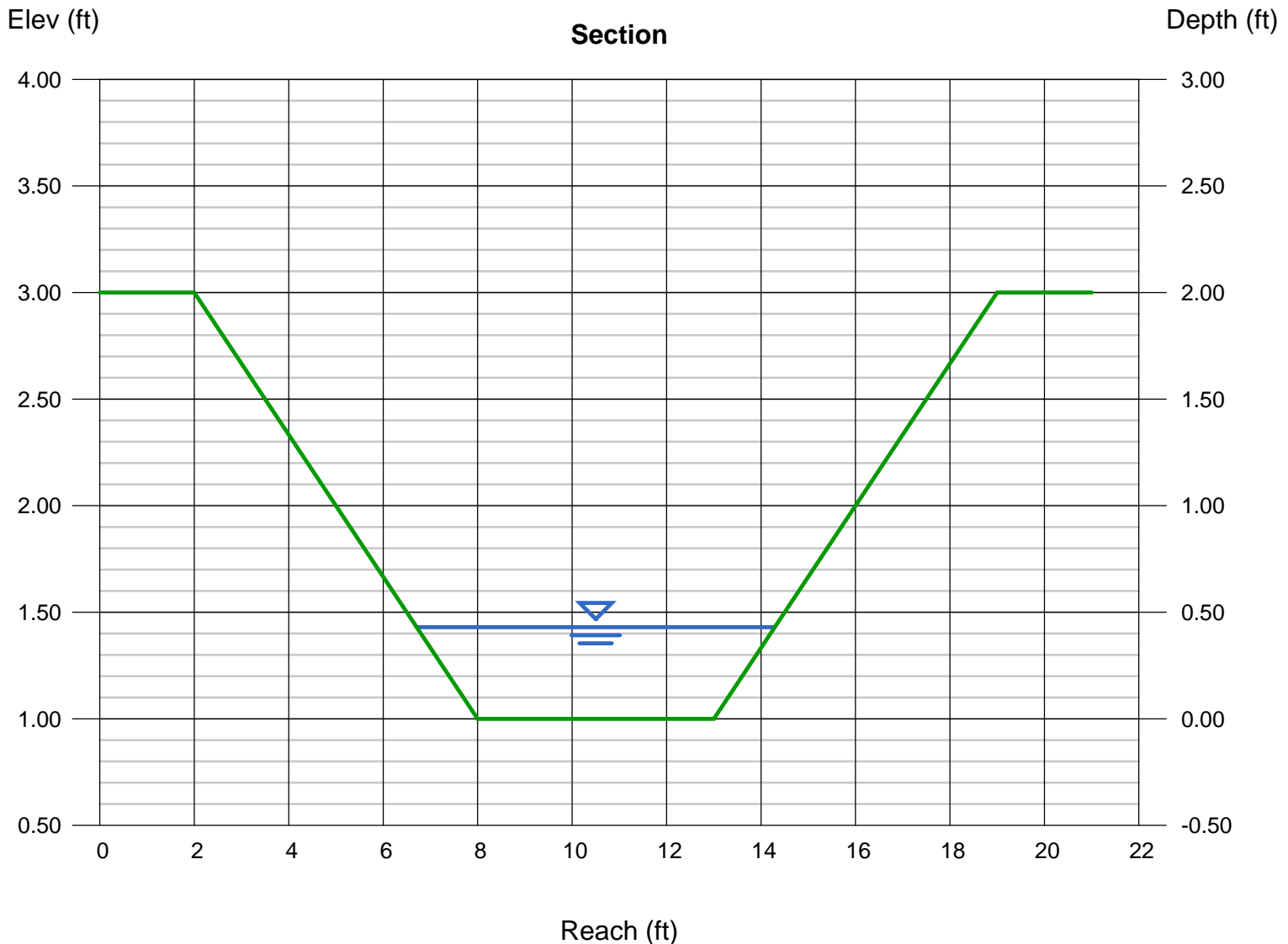

ATTACHMENT 4

Sediment Basin 3 Calculations

SCS ENGINEERS

2520 WHITEHALL PARK DRIVE
SUITE 450
CHARLOTTE, NC 28273

704-504-3107
704-504-3174 Fax

JOB YARNELL SED BASIN 3 CALCS
SHEET NO. 0 OF 23
CALCULATED BY SCC DATE 6/7/18
CHECKED BY JCT DATE 6/11/18
SCALE _____

SEDIMENT BASIN 3

STAGE - STORAGE CURVE p.2

PRINCIPAL SPILLWAY SIZING p.3

EMERGENCY SPILLWAY SIZING p.6

ANTI-SEEP COLLAR p.7

DEWATERING TIME p.8

POND VOLUME

DRAINAGE AREA = 7.51 Ac

DIRECT RUNOFF = 3.7 inches (CN 94) 25% / 24 hr

REQUIRED VOLUME 7.51 Ac x 43560 ft²/Ac x 3.7 in = 3,735 CY

<u>Elev</u>	<u>Area (ft²)</u>	<u>Volume (ft³)</u>
1107	19290	17762.5
1106	17235	32247
1104	15012	27918
1102	12906	23816
1100	10910	
TOTAL		<u><u>101,743 ft³ = 3,768 cy</u></u>

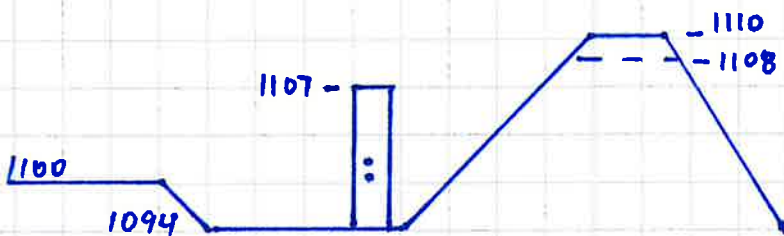

Wet Storage Req'd 67cy/Ac x 7.51
 = 503 cy

<u>Elev</u>	<u>Area (ft²)</u>	<u>Vol (ft³)</u>
1100	3618	
1098	2675	6293
1096	1840	4514
1094	1144	2984
TOTAL		<u><u>13,792</u></u>
		= <u><u>511 cy</u></u>

Sediment Basin #3
Stage - Storage Curve

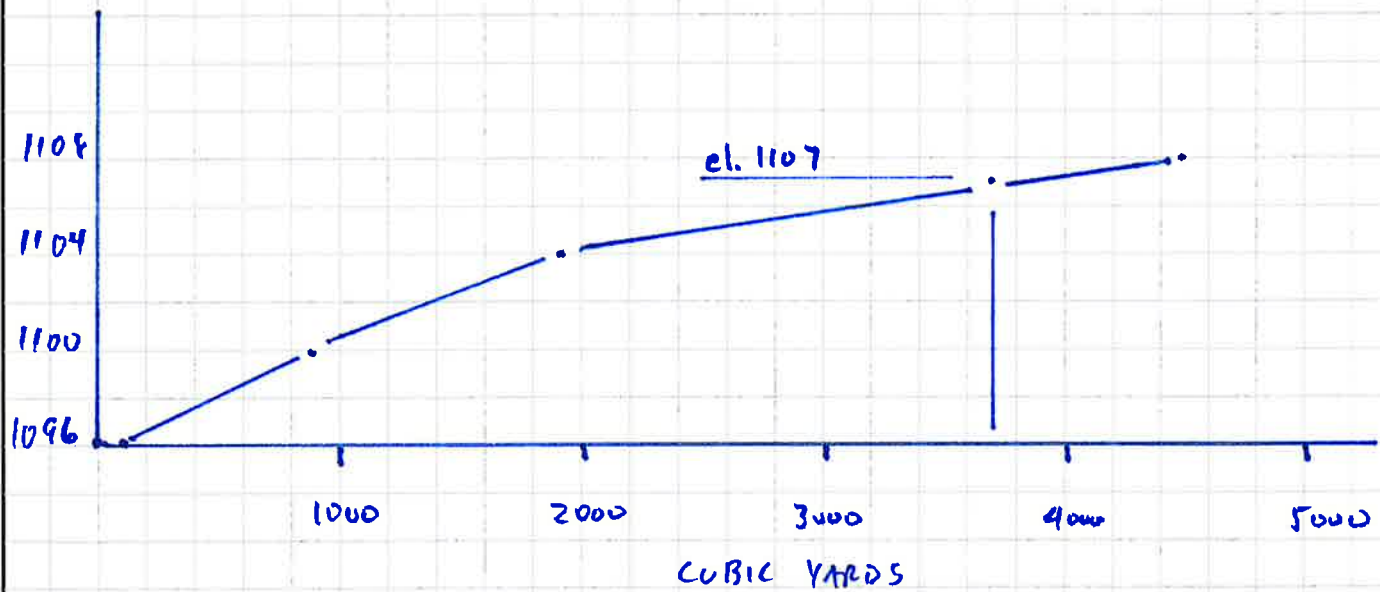

PRINCIPAL SPILLWAY

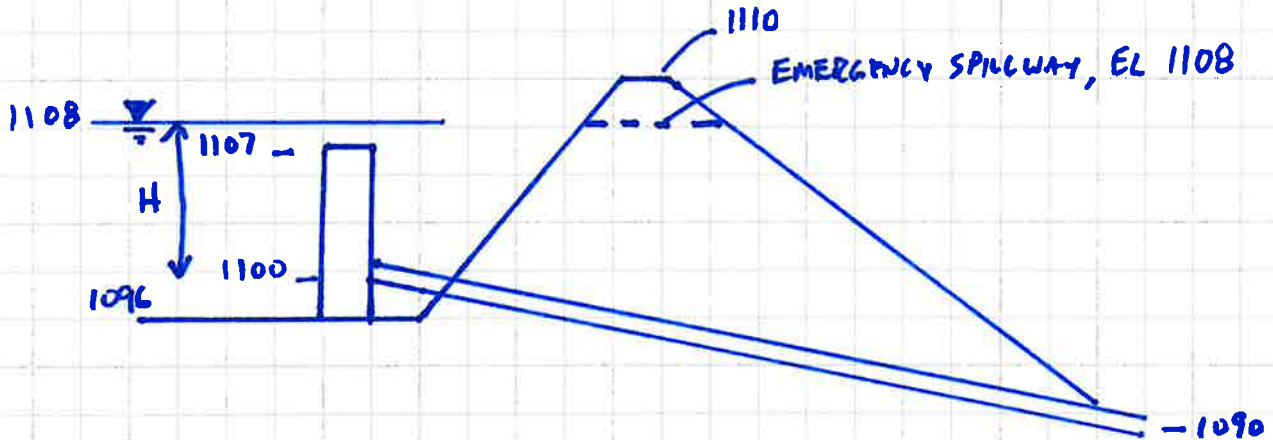
SELECT A BARREL SIZE THAT WILL PASS $Q_{25} = 44.2$ cfs

Pipe Flow Eq.

$$Q = A \left[\frac{2gH}{1 + K + h_f} \right]^{1/2}$$

$$h_f = \frac{185 \times 0.022^2 \times 100}{2.5^{4/3}} = 2.64$$

$$Q = 4.91 \left[\frac{2 \times 32.2 \times 8}{1 + 1 + 2.64} \right]^{1/2}$$

$$= \underline{\underline{51.7 \text{ cfs}}}$$

Q = flow (cfs)

A = Barrel area (ft²)

g = 32.2

K = K_{entrance} + K_{exit} ≈ 1.0

$$h_f = (185 \pi^2 L) / D^{4/3} \quad n = 0.022$$

$$H = 1108 - 1100 = \underline{\underline{8'}} \quad L = 100'$$

$$A = \frac{\pi D^2}{4} = 4.91 \text{ ft}^2 \quad D = 2.5'$$

Select Riser Diameter Try 36"

$$Q = C_o L h^{3/2}$$

(Weir Flow)

$$h = 0-1'$$

$$L = 2\pi R = 2\pi(1.5)' = 9.42 \text{ ft}$$

$$R_s = 1.5'$$

$$h_o/R_s = \frac{1}{1.5} = 0.66$$

From Fig 9-57 (Design of Small Dams)
 $C_o = 2.9$

$$Q = 2.9 \times 9.42 \times 1^{3/2} = 27.31 \text{ cfs (Weir flow)}$$

According to "Design of Small Dams", when h_o/R_s approaches 0.45, the top of riser will come submerged and weir flow changes to full pipe flow, therefore the barrel capacity controls.

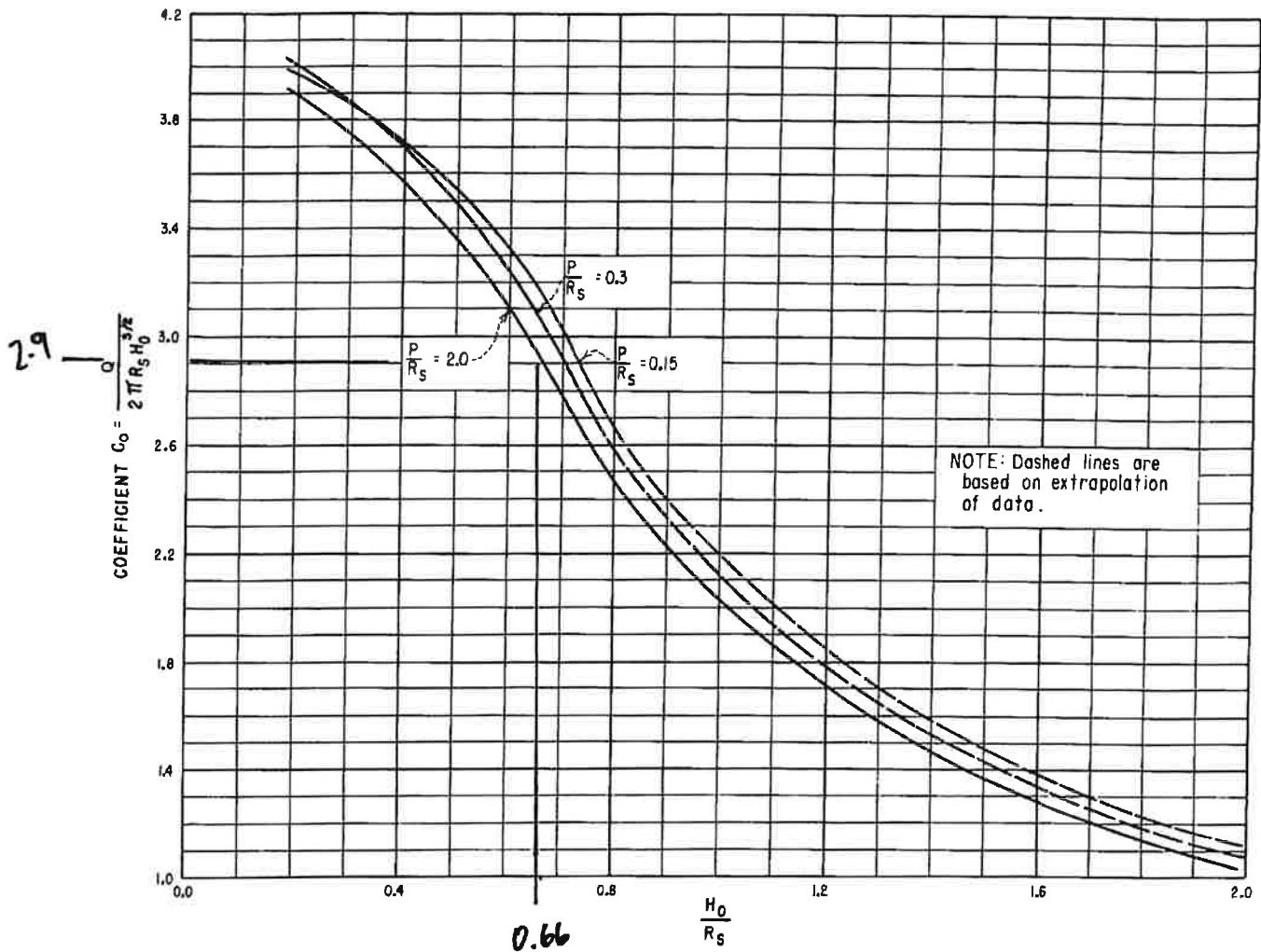

Figure 9-57.—Relationship of circular crest coefficient C_o to H_o/R_s for different approach depths (aerated nappes). 288-D-2441.

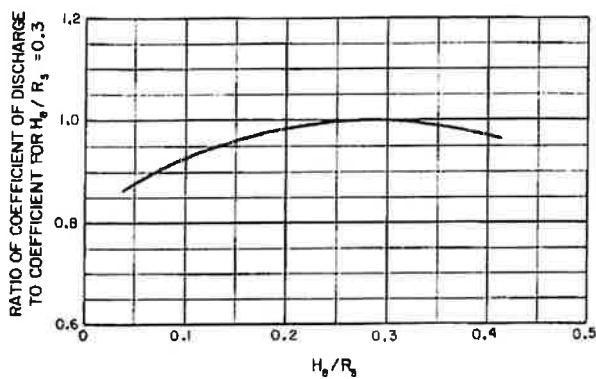

Figure 9-58.—Circular crest discharge coefficient for other than design head. 288-D-2442.

$R = Q_a^{1/2} / 5H_a^{1/4}$; where H_a is equal to the distance between the water surface and the elevation under consideration. The diameter of the jet thus decreases with the distance of the free vertical fall for normal design applications.

If an assumed total loss (including jet contraction losses, friction losses, velocity losses from direction changes, etc.) is taken as $0.1 H_a$, the equation for determining the approximate required shaft radius may be written:

$$R = 0.204 \frac{Q_a^{1/2}}{H_a^{1/4}} \quad (29)$$

Because this equation is for the shape of the jet,

DESIGN EMERGENCY SPILLWAY FOR $Q_{100} = 55.23$ cfs
BROAD-CRESTED WEIR EQ.

$$Q = B \sqrt{g} D_c^{3/2}$$

B = width (ft)

$g = 32.2$

D_c = critical depth $\approx \frac{2}{3} H = 0.67$ ft

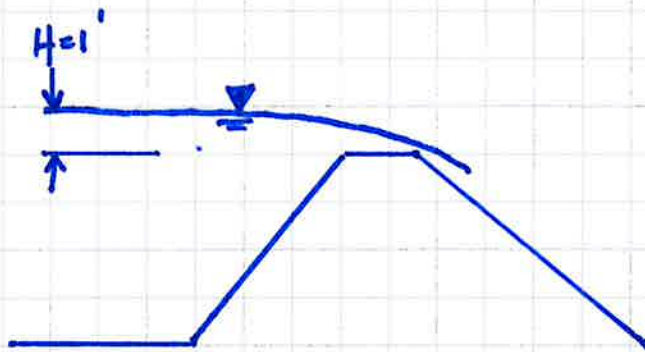

$$Q = B \sqrt{g} D_c^{3/2}$$

$$55.23 = B \sqrt{32.2} (.67)^{3/2}$$

$$55.23 = B (3.11) \quad \therefore B = 17.7 \text{ ft. Use } 18'$$

Check Velocity $Q = VA$ $A = 18' \times .67' = 12 \text{ ft}^2$

$$V = 55.23 / 12 = 4.6 \text{ fps} < 5.0 \text{ fps}$$

\therefore Use grass. No riprap is needed.

SCS ENGINEERS

2520 WHITEHALL PARK DRIVE
SUITE 450
CHARLOTTE, NC 28273

704-504-3107
704-504-3174 Fax

JOB Yonnell LF Sed. Basin 3
SHEET NO. 7 OF 23
CALCULATED BY SCC DATE 6/7/18
CHECKED BY JCT DATE 6/11/18
SCALE _____

Design ANTI-SEEP COLLARS

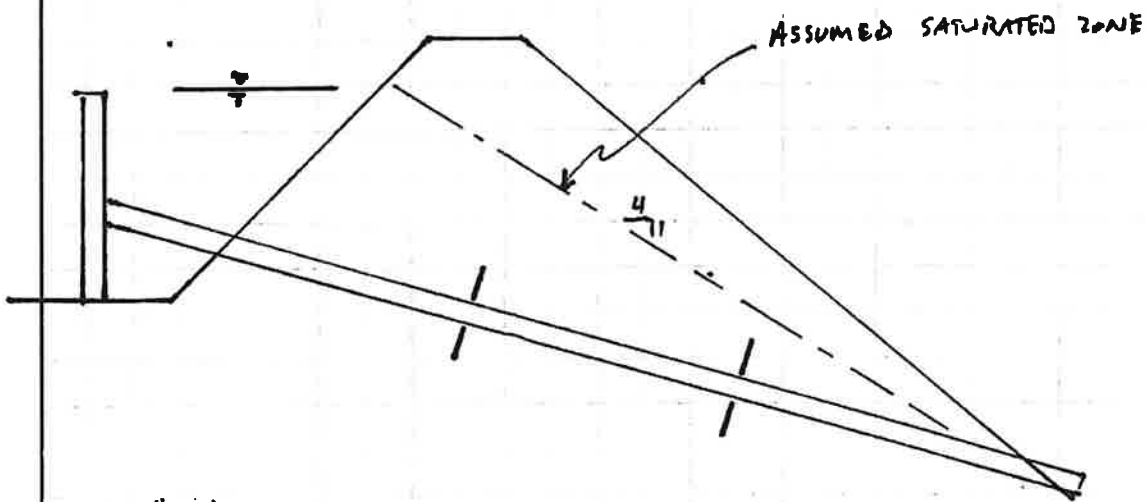

H: 1" = 20'
V: 1" = 10'

Seepage Length $\approx 80'$

Increase flow path by 10% or 8'

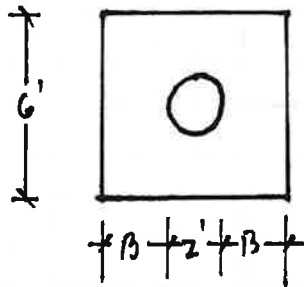

Use 2 collars $\therefore 2 \text{ collars} \times 2B = 8' \therefore \underline{\underline{B = 2'}}$

Calculate time to dewater pond

Volume of water to drain = 101,743 ft³
(see page 1)

An orifice size of 3.63" is needed to drain pond
in 3 days.

$$A = \frac{\pi D^2}{4} = \frac{\pi 3.63^2}{4} = 10.35 \text{ in}^2$$

$$1" \text{ } \varnothing \text{ perf} \Rightarrow A = \frac{\pi 1^2}{4} = 0.78 \text{ in}^2$$

Number of holes = 10.35/0.78 = 13.2 \therefore Use 14 holes

2 rows of 7 holes/ea.

Storage Nodes

Storage Node : Sed.Basin-003

Input Data

Invert Elevation (ft) 1100.00
 Max (Rim) Elevation (ft) 1107.00
 Max (Rim) Offset (ft) 7.00
 Initial Water Elevation (ft) 1107.00
 Initial Water Depth (ft) 7.00
 Ponded Area (ft²) 14535.00
 Evaporation Loss 0.00

Outflow Orifices

SN Element ID	Orifice Type	Orifice Shape	Flap Gate	Circular Orifice Diameter	Rectangular Orifice Height	Rectangular Orifice Width	Orifice Invert Elevation	Orifice Coefficient
				(in)	(in)	(in)	(ft)	
1 Orifice001	Side	CIRCULAR	No	3.63			1100.00	0.61

9/8/23

Total Inflow Node - Out-02 (Yarnell Pond v02 2018-09-26 13:25:38)

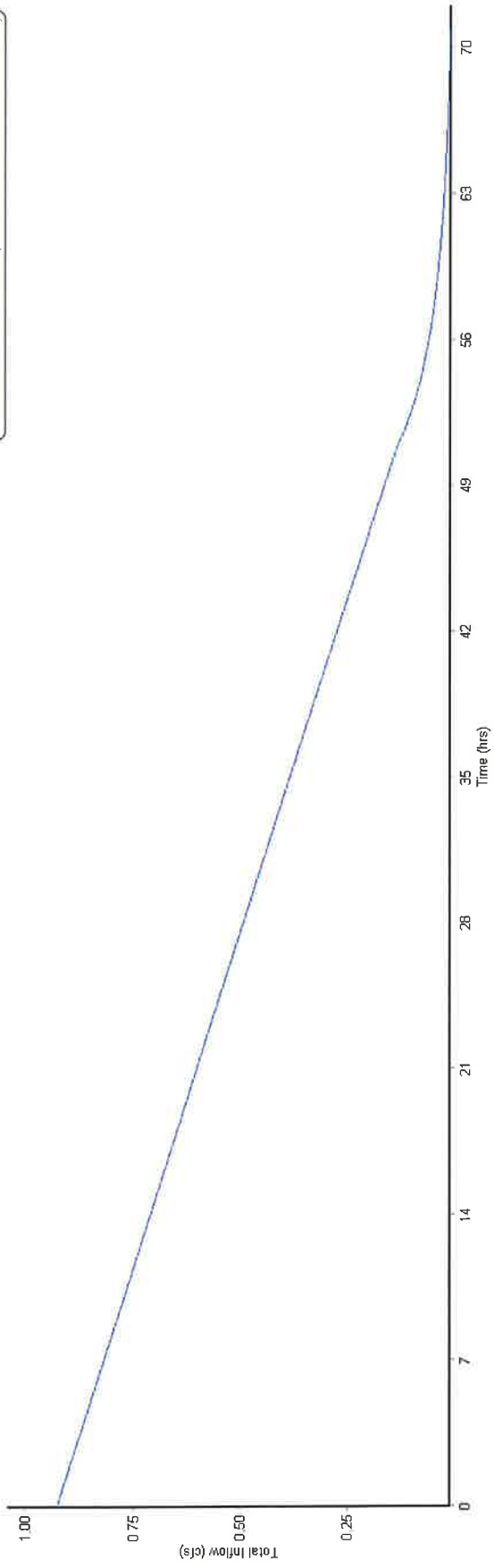

Stor-01				
Days	Hours	Water Depth (ft)	Water Surface Elevation (ft)	Volume (ft ³)
1	0:00:00	7	1107	101743
1	0:05:00	6.98	1106.98	101488
1	0:10:00	6.96	1106.96	101210.6
1	0:15:00	6.94	1106.94	100933.5
1	0:20:00	6.93	1106.93	100656.8
1	0:25:00	6.91	1106.91	100380.5
1	0:30:00	6.89	1106.89	100104.5
1	0:35:00	6.87	1106.87	99829.02
1	0:40:00	6.85	1106.85	99553.87
1	0:45:00	6.83	1106.83	99279.11
1	0:50:00	6.81	1106.81	99004.74
1	0:55:00	6.79	1106.79	98730.77
1	1:00:00	6.77	1106.77	98457.17
1	1:05:00	6.76	1106.76	98183.97
1	1:10:00	6.74	1106.74	97911.15
1	1:15:00	6.72	1106.72	97638.73
1	1:20:00	6.7	1106.7	97366.68
1	1:25:00	6.68	1106.68	97095.03
1	1:30:00	6.66	1106.66	96823.77
1	1:35:00	6.64	1106.64	96552.9
1	1:40:00	6.62	1106.62	96282.41
1	1:45:00	6.61	1106.61	96012.31
1	1:50:00	6.59	1106.59	95742.6
1	1:55:00	6.57	1106.57	95473.28
1	2:00:00	6.55	1106.55	95204.34
1	2:05:00	6.53	1106.53	94935.8
1	2:10:00	6.51	1106.51	94667.64
1	2:15:00	6.49	1106.49	94399.88
1	2:20:00	6.48	1106.48	94132.49
1	2:25:00	6.46	1106.46	93865.5
1	2:30:00	6.44	1106.44	93598.9
1	2:35:00	6.42	1106.42	93332.68
1	2:40:00	6.4	1106.4	93066.85
1	2:45:00	6.38	1106.38	92801.41
1	2:50:00	6.37	1106.37	92536.36
1	2:55:00	6.35	1106.35	92271.7
1	3:00:00	6.33	1106.33	92007.42
1	3:05:00	6.31	1106.31	91743.54
1	3:10:00	6.29	1106.29	91480.04
1	3:15:00	6.28	1106.28	91216.93
1	3:20:00	6.26	1106.26	90954.21
1	3:25:00	6.24	1106.24	90691.88
1	3:30:00	6.22	1106.22	90429.93
1	3:35:00	6.2	1106.2	90168.38
1	3:40:00	6.19	1106.19	89907.2
1	3:45:00	6.17	1106.17	89646.42
1	3:50:00	6.15	1106.15	89386.03
1	3:55:00	6.13	1106.13	89126.02
1	4:00:00	6.11	1106.11	88866.41
1	4:05:00	6.1	1106.1	88607.18
1	4:10:00	6.08	1106.08	88348.34
1	4:15:00	6.06	1106.06	88089.89
1	4:20:00	6.04	1106.04	87831.83
1	4:25:00	6.03	1106.03	87574.16
1	4:30:00	6.01	1106.01	87316.87
1	4:35:00	5.99	1105.99	87059.97
1	4:40:00	5.97	1105.97	86803.46
1	4:45:00	5.95	1105.95	86547.34
1	4:50:00	5.94	1105.94	86291.61
1	4:55:00	5.92	1105.92	86036.26

1	5:00:00	5.9	1105.9	85781.3
1	5:05:00	5.88	1105.88	85526.73
1	5:10:00	5.87	1105.87	85272.55
1	5:15:00	5.85	1105.85	85018.77
1	5:20:00	5.83	1105.83	84765.36
1	5:25:00	5.81	1105.81	84512.34
1	5:30:00	5.8	1105.8	84259.71
1	5:35:00	5.78	1105.78	84007.48
1	5:40:00	5.76	1105.76	83755.63
1	5:45:00	5.75	1105.75	83504.16
1	5:50:00	5.73	1105.73	83253.09
1	5:55:00	5.71	1105.71	83002.4
1	6:00:00	5.69	1105.69	82752.1
1	6:05:00	5.68	1105.68	82502.2
1	6:10:00	5.66	1105.66	82252.67
1	6:15:00	5.64	1105.64	82003.54
1	6:20:00	5.62	1105.62	81754.79
1	6:25:00	5.61	1105.61	81506.44
1	6:30:00	5.59	1105.59	81258.47
1	6:35:00	5.57	1105.57	81010.88
1	6:40:00	5.56	1105.56	80763.7
1	6:45:00	5.54	1105.54	80516.89
1	6:50:00	5.52	1105.52	80270.48
1	6:55:00	5.51	1105.51	80024.45
1	7:00:00	5.49	1105.49	79778.8
1	7:05:00	5.47	1105.47	79533.55
1	7:10:00	5.46	1105.46	79288.7
1	7:15:00	5.44	1105.44	79044.22
1	7:20:00	5.42	1105.42	78800.13
1	7:25:00	5.4	1105.4	78556.44
1	7:30:00	5.39	1105.39	78313.13
1	7:35:00	5.37	1105.37	78070.2
1	7:40:00	5.35	1105.35	77827.67
1	7:45:00	5.34	1105.34	77585.52
1	7:50:00	5.32	1105.32	77343.77
1	7:55:00	5.3	1105.3	77102.4
1	8:00:00	5.29	1105.29	76861.42
1	8:05:00	5.27	1105.27	76620.83
1	8:10:00	5.26	1105.26	76380.63
1	8:15:00	5.24	1105.24	76140.8
1	8:20:00	5.22	1105.22	75901.38
1	8:25:00	5.21	1105.21	75662.34
1	8:30:00	5.19	1105.19	75423.69
1	8:35:00	5.17	1105.17	75185.43
1	8:40:00	5.16	1105.16	74947.55
1	8:45:00	5.14	1105.14	74710.07
1	8:50:00	5.12	1105.12	74472.97
1	8:55:00	5.11	1105.11	74236.26
1	9:00:00	5.09	1105.09	73999.94
1	9:05:00	5.07	1105.07	73764.01
1	9:10:00	5.06	1105.06	73528.46
1	9:15:00	5.04	1105.04	73293.3
1	9:20:00	5.03	1105.03	73058.53
1	9:25:00	5.01	1105.01	72824.16
1	9:30:00	4.99	1104.99	72590.16
1	9:35:00	4.98	1104.98	72356.55
1	9:40:00	4.96	1104.96	72123.34
1	9:45:00	4.95	1104.95	71890.52
1	9:50:00	4.93	1104.93	71658.08
1	9:55:00	4.91	1104.91	71426.02
1	10:00:00	4.9	1104.9	71194.36
1	10:05:00	4.88	1104.88	70963.09
1	10:10:00	4.87	1104.87	70732.2
1	10:15:00	4.85	1104.85	70501.7

1 10:20:00	4.83	1104.83	70271.59
1 10:25:00	4.82	1104.82	70041.88
1 10:30:00	4.8	1104.8	69812.54
1 10:35:00	4.79	1104.79	69583.59
1 10:40:00	4.77	1104.77	69355.04
1 10:45:00	4.76	1104.76	69126.87
1 10:50:00	4.74	1104.74	68899.09
1 10:55:00	4.72	1104.72	68671.7
1 11:00:00	4.71	1104.71	68444.7
1 11:05:00	4.69	1104.69	68218.08
1 11:10:00	4.68	1104.68	67991.85
1 11:15:00	4.66	1104.66	67766.02
1 11:20:00	4.65	1104.65	67540.56
1 11:25:00	4.63	1104.63	67315.5
1 11:30:00	4.62	1104.62	67090.83
1 11:35:00	4.6	1104.6	66866.54
1 11:40:00	4.59	1104.59	66642.64
1 11:45:00	4.57	1104.57	66419.13
1 11:50:00	4.55	1104.55	66196.01
1 11:55:00	4.54	1104.54	65973.28
1 12:00:00	4.52	1104.52	65750.93
1 12:05:00	4.51	1104.51	65528.98
1 12:10:00	4.49	1104.49	65307.41
1 12:15:00	4.48	1104.48	65086.23
1 12:20:00	4.46	1104.46	64865.44
1 12:25:00	4.45	1104.45	64645.03
1 12:30:00	4.43	1104.43	64425.02
1 12:35:00	4.42	1104.42	64205.39
1 12:40:00	4.4	1104.4	63986.15
1 12:45:00	4.39	1104.39	63767.3
1 12:50:00	4.37	1104.37	63548.84
1 12:55:00	4.36	1104.36	63330.77
1 13:00:00	4.34	1104.34	63113.08
1 13:05:00	4.33	1104.33	62895.78
1 13:10:00	4.31	1104.31	62678.87
1 13:15:00	4.3	1104.3	62462.35
1 13:20:00	4.28	1104.28	62246.22
1 13:25:00	4.27	1104.27	62030.47
1 13:30:00	4.25	1104.25	61815.12
1 13:35:00	4.24	1104.24	61600.15
1 13:40:00	4.22	1104.22	61385.57
1 13:45:00	4.21	1104.21	61171.38
1 13:50:00	4.19	1104.19	60957.57
1 13:55:00	4.18	1104.18	60744.16
1 14:00:00	4.16	1104.16	60531.13
1 14:05:00	4.15	1104.15	60318.49
1 14:10:00	4.14	1104.14	60106.24
1 14:15:00	4.12	1104.12	59894.38
1 14:20:00	4.11	1104.11	59682.91
1 14:25:00	4.09	1104.09	59471.82
1 14:30:00	4.08	1104.08	59261.12
1 14:35:00	4.06	1104.06	59050.8
1 14:40:00	4.05	1104.05	58840.88
1 14:45:00	4.03	1104.03	58631.34
1 14:50:00	4.02	1104.02	58422.19
1 14:55:00	4.01	1104.01	58213.43
1 15:00:00	3.99	1103.99	58005.05
1 15:05:00	3.98	1103.98	57797.06
1 15:10:00	3.96	1103.96	57589.46
1 15:15:00	3.95	1103.95	57382.25
1 15:20:00	3.93	1103.93	57175.43
1 15:25:00	3.92	1103.92	56968.99
1 15:30:00	3.91	1103.91	56762.95
1 15:35:00	3.89	1103.89	56557.29

1 15:40:00	3.88	1103.88	56352.02
1 15:45:00	3.86	1103.86	56147.13
1 15:50:00	3.85	1103.85	55942.64
1 15:55:00	3.83	1103.83	55738.54
1 16:00:00	3.82	1103.82	55534.82
1 16:05:00	3.81	1103.81	55331.49
1 16:10:00	3.79	1103.79	55128.55
1 16:15:00	3.78	1103.78	54926
1 16:20:00	3.77	1103.77	54723.83
1 16:25:00	3.75	1103.75	54522.06
1 16:30:00	3.74	1103.74	54320.67
1 16:35:00	3.72	1103.72	54119.67
1 16:40:00	3.71	1103.71	53919.06
1 16:45:00	3.7	1103.7	53718.84
1 16:50:00	3.68	1103.68	53519
1 16:55:00	3.67	1103.67	53319.55
1 17:00:00	3.66	1103.66	53120.48
1 17:05:00	3.64	1103.64	52921.81
1 17:10:00	3.63	1103.63	52723.52
1 17:15:00	3.61	1103.61	52525.63
1 17:20:00	3.6	1103.6	52328.12
1 17:25:00	3.59	1103.59	52131
1 17:30:00	3.57	1103.57	51934.26
1 17:35:00	3.56	1103.56	51737.92
1 17:40:00	3.55	1103.55	51541.96
1 17:45:00	3.53	1103.53	51346.39
1 17:50:00	3.52	1103.52	51151.21
1 17:55:00	3.51	1103.51	50956.42
1 18:00:00	3.49	1103.49	50762.02
1 18:05:00	3.48	1103.48	50568
1 18:10:00	3.47	1103.47	50374.38
1 18:15:00	3.45	1103.45	50181.14
1 18:20:00	3.44	1103.44	49988.29
1 18:25:00	3.43	1103.43	49795.82
1 18:30:00	3.41	1103.41	49603.75
1 18:35:00	3.4	1103.4	49412.07
1 18:40:00	3.39	1103.39	49220.77
1 18:45:00	3.37	1103.37	49029.86
1 18:50:00	3.36	1103.36	48839.34
1 18:55:00	3.35	1103.35	48649.21
1 19:00:00	3.33	1103.33	48459.46
1 19:05:00	3.32	1103.32	48270.11
1 19:10:00	3.31	1103.31	48081.14
1 19:15:00	3.3	1103.3	47892.56
1 19:20:00	3.28	1103.28	47704.37
1 19:25:00	3.27	1103.27	47516.57
1 19:30:00	3.26	1103.26	47329.15
1 19:35:00	3.24	1103.24	47142.13
1 19:40:00	3.23	1103.23	46955.49
1 19:45:00	3.22	1103.22	46769.24
1 19:50:00	3.21	1103.21	46583.38
1 19:55:00	3.19	1103.19	46397.91
1 20:00:00	3.18	1103.18	46212.82
1 20:05:00	3.17	1103.17	46028.13
1 20:10:00	3.15	1103.15	45843.82
1 20:15:00	3.14	1103.14	45659.89
1 20:20:00	3.13	1103.13	45476.36
1 20:25:00	3.12	1103.12	45293.22
1 20:30:00	3.1	1103.1	45110.46
1 20:35:00	3.09	1103.09	44928.1
1 20:40:00	3.08	1103.08	44746.12
1 20:45:00	3.07	1103.07	44564.53
1 20:50:00	3.05	1103.05	44383.33
1 20:55:00	3.04	1103.04	44202.51

1	21:00:00	3.03	1103.03	44022.09
1	21:05:00	3.02	1103.02	43842.05
1	21:10:00	3	1103	43662.4
1	21:15:00	2.99	1102.99	43483.14
1	21:20:00	2.98	1102.98	43304.27
1	21:25:00	2.97	1102.97	43125.79
1	21:30:00	2.96	1102.96	42947.69
1	21:35:00	2.94	1102.94	42769.98
1	21:40:00	2.93	1102.93	42592.66
1	21:45:00	2.92	1102.92	42415.73
1	21:50:00	2.91	1102.91	42239.19
1	21:55:00	2.89	1102.89	42063.04
1	22:00:00	2.88	1102.88	41887.27
1	22:05:00	2.87	1102.87	41711.89
1	22:10:00	2.86	1102.86	41536.9
1	22:15:00	2.85	1102.85	41362.3
1	22:20:00	2.83	1102.83	41188.09
1	22:25:00	2.82	1102.82	41014.26
1	22:30:00	2.81	1102.81	40840.82
1	22:35:00	2.8	1102.8	40667.78
1	22:40:00	2.79	1102.79	40495.12
1	22:45:00	2.77	1102.77	40322.84
1	22:50:00	2.76	1102.76	40150.96
1	22:55:00	2.75	1102.75	39979.47
1	23:00:00	2.74	1102.74	39808.36
1	23:05:00	2.73	1102.73	39637.64
1	23:10:00	2.72	1102.72	39467.31
1	23:15:00	2.7	1102.7	39297.37
1	23:20:00	2.69	1102.69	39127.82
1	23:25:00	2.68	1102.68	38958.65
1	23:30:00	2.67	1102.67	38789.88
1	23:35:00	2.66	1102.66	38621.48
1	23:40:00	2.65	1102.65	38453.48
1	23:45:00	2.63	1102.63	38285.87
1	23:50:00	2.62	1102.62	38118.65
1	23:55:00	2.61	1102.61	37951.81
2	0:00:00	2.6	1102.6	37785.36
2	0:05:00	2.59	1102.59	37619.3
2	0:10:00	2.58	1102.58	37453.63
2	0:15:00	2.57	1102.57	37288.35
2	0:20:00	2.55	1102.55	37123.45
2	0:25:00	2.54	1102.54	36958.94
2	0:30:00	2.53	1102.53	36794.81
2	0:35:00	2.52	1102.52	36631.08
2	0:40:00	2.51	1102.51	36467.73
2	0:45:00	2.5	1102.5	36304.77
2	0:50:00	2.49	1102.49	36142.2
2	0:55:00	2.48	1102.48	35980.02
2	1:00:00	2.46	1102.46	35818.22
2	1:05:00	2.45	1102.45	35656.82
2	1:10:00	2.44	1102.44	35495.8
2	1:15:00	2.43	1102.43	35335.17
2	1:20:00	2.42	1102.42	35174.93
2	1:25:00	2.41	1102.41	35015.08
2	1:30:00	2.4	1102.4	34855.61
2	1:35:00	2.39	1102.39	34696.54
2	1:40:00	2.38	1102.38	34537.85
2	1:45:00	2.37	1102.37	34379.55
2	1:50:00	2.35	1102.35	34221.64
2	1:55:00	2.34	1102.34	34064.12
2	2:00:00	2.33	1102.33	33906.98
2	2:05:00	2.32	1102.32	33750.23
2	2:10:00	2.31	1102.31	33593.88
2	2:15:00	2.3	1102.3	33437.91

2	2:20:00	2.29	1102.29	33282.32
2	2:25:00	2.28	1102.28	33127.13
2	2:30:00	2.27	1102.27	32972.33
2	2:35:00	2.26	1102.26	32817.91
2	2:40:00	2.25	1102.25	32663.88
2	2:45:00	2.24	1102.24	32510.24
2	2:50:00	2.23	1102.23	32356.99
2	2:55:00	2.22	1102.22	32204.12
2	3:00:00	2.21	1102.21	32051.64
2	3:05:00	2.2	1102.2	31899.55
2	3:10:00	2.18	1102.18	31747.85
2	3:15:00	2.17	1102.17	31596.54
2	3:20:00	2.16	1102.16	31445.61
2	3:25:00	2.15	1102.15	31295.08
2	3:30:00	2.14	1102.14	31144.93
2	3:35:00	2.13	1102.13	30995.17
2	3:40:00	2.12	1102.12	30845.79
2	3:45:00	2.11	1102.11	30696.81
2	3:50:00	2.1	1102.1	30548.21
2	3:55:00	2.09	1102.09	30400
2	4:00:00	2.08	1102.08	30252.18
2	4:05:00	2.07	1102.07	30104.75
2	4:10:00	2.06	1102.06	29957.71
2	4:15:00	2.05	1102.05	29811.04
2	4:20:00	2.04	1102.04	29664.78
2	4:25:00	2.03	1102.03	29518.89
2	4:30:00	2.02	1102.02	29373.4
2	4:35:00	2.01	1102.01	29228.28
2	4:40:00	2	1102	29083.56
2	4:45:00	1.99	1101.99	28939.22
2	4:50:00	1.98	1101.98	28795.27
2	4:55:00	1.97	1101.97	28651.71
2	5:00:00	1.96	1101.96	28508.54
2	5:05:00	1.95	1101.95	28365.76
2	5:10:00	1.94	1101.94	28223.37
2	5:15:00	1.93	1101.93	28081.36
2	5:20:00	1.92	1101.92	27939.74
2	5:25:00	1.91	1101.91	27798.51
2	5:30:00	1.9	1101.9	27657.67
2	5:35:00	1.89	1101.89	27517.22
2	5:40:00	1.88	1101.88	27377.15
2	5:45:00	1.87	1101.87	27237.48
2	5:50:00	1.86	1101.86	27098.19
2	5:55:00	1.86	1101.86	26959.29
2	6:00:00	1.85	1101.85	26820.78
2	6:05:00	1.84	1101.84	26682.66
2	6:10:00	1.83	1101.83	26544.92
2	6:15:00	1.82	1101.82	26407.58
2	6:20:00	1.81	1101.81	26270.62
2	6:25:00	1.8	1101.8	26134.05
2	6:30:00	1.79	1101.79	25997.87
2	6:35:00	1.78	1101.78	25862.08
2	6:40:00	1.77	1101.77	25726.67
2	6:45:00	1.76	1101.76	25591.66
2	6:50:00	1.75	1101.75	25457.03
2	6:55:00	1.74	1101.74	25322.79
2	7:00:00	1.73	1101.73	25188.94
2	7:05:00	1.72	1101.72	25055.48
2	7:10:00	1.72	1101.72	24922.4
2	7:15:00	1.71	1101.71	24789.72
2	7:20:00	1.7	1101.7	24657.42
2	7:25:00	1.69	1101.69	24525.51
2	7:30:00	1.68	1101.68	24393.99
2	7:35:00	1.67	1101.67	24262.86

2	7:40:00	1.66	1101.66	24132.12
2	7:45:00	1.65	1101.65	24001.76
2	7:50:00	1.64	1101.64	23871.79
2	7:55:00	1.63	1101.63	23742.21
2	8:00:00	1.63	1101.63	23613.02
2	8:05:00	1.62	1101.62	23484.22
2	8:10:00	1.61	1101.61	23355.81
2	8:15:00	1.6	1101.6	23227.78
2	8:20:00	1.59	1101.59	23100.15
2	8:25:00	1.58	1101.58	22972.9
2	8:30:00	1.57	1101.57	22846.04
2	8:35:00	1.56	1101.56	22719.57
2	8:40:00	1.56	1101.56	22593.48
2	8:45:00	1.55	1101.55	22467.79
2	8:50:00	1.54	1101.54	22342.48
2	8:55:00	1.53	1101.53	22217.56
2	9:00:00	1.52	1101.52	22093.03
2	9:05:00	1.51	1101.51	21968.89
2	9:10:00	1.5	1101.5	21845.14
2	9:15:00	1.5	1101.49	21721.77
2	9:20:00	1.49	1101.49	21598.8
2	9:25:00	1.48	1101.48	21476.21
2	9:30:00	1.47	1101.47	21354.01
2	9:35:00	1.46	1101.46	21232.2
2	9:40:00	1.45	1101.45	21110.78
2	9:45:00	1.44	1101.44	20989.74
2	9:50:00	1.44	1101.44	20869.1
2	9:55:00	1.43	1101.43	20748.84
2	10:00:00	1.42	1101.42	20628.97
2	10:05:00	1.41	1101.41	20509.49
2	10:10:00	1.4	1101.4	20390.39
2	10:15:00	1.4	1101.4	20271.69
2	10:20:00	1.39	1101.39	20153.38
2	10:25:00	1.38	1101.38	20035.45
2	10:30:00	1.37	1101.37	19917.91
2	10:35:00	1.36	1101.36	19800.76
2	10:40:00	1.35	1101.35	19683.99
2	10:45:00	1.35	1101.35	19567.62
2	10:50:00	1.34	1101.34	19451.63
2	10:55:00	1.33	1101.33	19336.04
2	11:00:00	1.32	1101.32	19220.83
2	11:05:00	1.32	1101.32	19106.01
2	11:10:00	1.31	1101.31	18991.58
2	11:15:00	1.3	1101.3	18877.53
2	11:20:00	1.29	1101.29	18763.88
2	11:25:00	1.28	1101.28	18650.61
2	11:30:00	1.28	1101.28	18537.73
2	11:35:00	1.27	1101.27	18425.24
2	11:40:00	1.26	1101.26	18313.14
2	11:45:00	1.25	1101.25	18201.43
2	11:50:00	1.25	1101.25	18090.1
2	11:55:00	1.24	1101.24	17979.17
2	12:00:00	1.23	1101.23	17868.62
2	12:05:00	1.22	1101.22	17758.46
2	12:10:00	1.21	1101.21	17648.69
2	12:15:00	1.21	1101.21	17539.3
2	12:20:00	1.2	1101.2	17430.31
2	12:25:00	1.19	1101.19	17321.71
2	12:30:00	1.18	1101.18	17213.49
2	12:35:00	1.18	1101.18	17105.66
2	12:40:00	1.17	1101.17	16998.22
2	12:45:00	1.16	1101.16	16891.16
2	12:50:00	1.16	1101.16	16784.5
2	12:55:00	1.15	1101.15	16678.22

2 13:00:00	1.14	1101.14	16572.34
2 13:05:00	1.13	1101.13	16466.84
2 13:10:00	1.13	1101.13	16361.73
2 13:15:00	1.12	1101.12	16257.01
2 13:20:00	1.11	1101.11	16152.67
2 13:25:00	1.1	1101.1	16048.73
2 13:30:00	1.1	1101.1	15945.17
2 13:35:00	1.09	1101.09	15842
2 13:40:00	1.08	1101.08	15739.22
2 13:45:00	1.08	1101.08	15636.83
2 13:50:00	1.07	1101.07	15534.83
2 13:55:00	1.06	1101.06	15433.21
2 14:00:00	1.06	1101.06	15331.99
2 14:05:00	1.05	1101.05	15231.15
2 14:10:00	1.04	1101.04	15130.7
2 14:15:00	1.03	1101.03	15030.64
2 14:20:00	1.03	1101.03	14930.96
2 14:25:00	1.02	1101.02	14831.68
2 14:30:00	1.01	1101.01	14732.78
2 14:35:00	1.01	1101.01	14634.28
2 14:40:00	1	1101	14536.16
2 14:45:00	0.99	1100.99	14438.43
2 14:50:00	0.99	1100.99	14341.08
2 14:55:00	0.98	1100.98	14244.13
2 15:00:00	0.97	1100.97	14147.57
2 15:05:00	0.97	1100.97	14051.39
2 15:10:00	0.96	1100.96	13955.6
2 15:15:00	0.95	1100.95	13860.2
2 15:20:00	0.95	1100.95	13765.19
2 15:25:00	0.94	1100.94	13670.56
2 15:30:00	0.93	1100.93	13576.33
2 15:35:00	0.93	1100.93	13482.48
2 15:40:00	0.92	1100.92	13389.03
2 15:45:00	0.92	1100.92	13295.96
2 15:50:00	0.91	1100.91	13203.27
2 15:55:00	0.9	1100.9	13110.98
2 16:00:00	0.9	1100.9	13019.08
2 16:05:00	0.89	1100.89	12927.56
2 16:10:00	0.88	1100.88	12836.43
2 16:15:00	0.88	1100.88	12745.7
2 16:20:00	0.87	1100.87	12655.34
2 16:25:00	0.86	1100.86	12565.38
2 16:30:00	0.86	1100.86	12475.81
2 16:35:00	0.85	1100.85	12386.62
2 16:40:00	0.85	1100.85	12297.83
2 16:45:00	0.84	1100.84	12209.42
2 16:50:00	0.83	1100.83	12121.4
2 16:55:00	0.83	1100.83	12033.77
2 17:00:00	0.82	1100.82	11946.52
2 17:05:00	0.82	1100.82	11859.67
2 17:10:00	0.81	1100.81	11773.2
2 17:15:00	0.8	1100.8	11687.13
2 17:20:00	0.8	1100.8	11601.44
2 17:25:00	0.79	1100.79	11516.13
2 17:30:00	0.79	1100.79	11431.22
2 17:35:00	0.78	1100.78	11346.7
2 17:40:00	0.78	1100.78	11262.56
2 17:45:00	0.77	1100.77	11178.82
2 17:50:00	0.76	1100.76	11095.46
2 17:55:00	0.76	1100.76	11012.49
2 18:00:00	0.75	1100.75	10929.91
2 18:05:00	0.75	1100.75	10847.71
2 18:10:00	0.74	1100.74	10765.91
2 18:15:00	0.74	1100.74	10684.49

2	18:20:00	0.73	1100.73	10603.46
2	18:25:00	0.72	1100.72	10522.82
2	18:30:00	0.72	1100.72	10442.57
2	18:35:00	0.71	1100.71	10362.71
2	18:40:00	0.71	1100.71	10283.24
2	18:45:00	0.7	1100.7	10204.15
2	18:50:00	0.7	1100.7	10125.45
2	18:55:00	0.69	1100.69	10047.15
2	19:00:00	0.69	1100.69	9969.22
2	19:05:00	0.68	1100.68	9891.69
2	19:10:00	0.68	1100.68	9814.55
2	19:15:00	0.67	1100.67	9737.79
2	19:20:00	0.67	1100.67	9661.43
2	19:25:00	0.66	1100.66	9585.45
2	19:30:00	0.65	1100.65	9509.86
2	19:35:00	0.65	1100.65	9434.66
2	19:40:00	0.64	1100.64	9359.85
2	19:45:00	0.64	1100.64	9285.42
2	19:50:00	0.63	1100.63	9211.39
2	19:55:00	0.63	1100.63	9137.74
2	20:00:00	0.62	1100.62	9064.48
2	20:05:00	0.62	1100.62	8991.61
2	20:10:00	0.61	1100.61	8919.13
2	20:15:00	0.61	1100.61	8847.04
2	20:20:00	0.6	1100.6	8775.33
2	20:25:00	0.6	1100.6	8704.02
2	20:30:00	0.59	1100.59	8633.09
2	20:35:00	0.59	1100.59	8562.55
2	20:40:00	0.58	1100.58	8492.4
2	20:45:00	0.58	1100.58	8422.64
2	20:50:00	0.58	1100.58	8353.27
2	20:55:00	0.57	1100.57	8284.28
2	21:00:00	0.57	1100.57	8215.69
2	21:05:00	0.56	1100.56	8147.48
2	21:10:00	0.56	1100.56	8079.66
2	21:15:00	0.55	1100.55	8012.23
2	21:20:00	0.55	1100.55	7945.18
2	21:25:00	0.54	1100.54	7878.53
2	21:30:00	0.54	1100.54	7812.27
2	21:35:00	0.53	1100.53	7746.39
2	21:40:00	0.53	1100.53	7680.9
2	21:45:00	0.52	1100.52	7615.8
2	21:50:00	0.52	1100.52	7551.09
2	21:55:00	0.52	1100.52	7486.77
2	22:00:00	0.51	1100.51	7422.83
2	22:05:00	0.51	1100.51	7359.29
2	22:10:00	0.5	1100.5	7296.13
2	22:15:00	0.5	1100.5	7233.36
2	22:20:00	0.49	1100.49	7170.98
2	22:25:00	0.49	1100.49	7108.99
2	22:30:00	0.49	1100.49	7047.38
2	22:35:00	0.48	1100.48	6986.17
2	22:40:00	0.48	1100.48	6925.34
2	22:45:00	0.47	1100.47	6864.91
2	22:50:00	0.47	1100.47	6804.86
2	22:55:00	0.46	1100.46	6745.2
2	23:00:00	0.46	1100.46	6685.93
2	23:05:00	0.46	1100.46	6627.04
2	23:10:00	0.45	1100.45	6568.55
2	23:15:00	0.45	1100.45	6510.44
2	23:20:00	0.44	1100.44	6452.72
2	23:25:00	0.44	1100.44	6395.39
2	23:30:00	0.44	1100.44	6338.45
2	23:35:00	0.43	1100.43	6281.9

19/23

2	23:40:00	0.43	1100.43	6225.74
2	23:45:00	0.42	1100.42	6169.96
2	23:50:00	0.42	1100.42	6114.58
2	23:55:00	0.42	1100.42	6059.58
3	0:00:00	0.41	1100.41	6004.97
3	0:05:00	0.41	1100.41	5950.75
3	0:10:00	0.41	1100.41	5896.92
3	0:15:00	0.4	1100.4	5843.47
3	0:20:00	0.4	1100.4	5790.42
3	0:25:00	0.4	1100.4	5737.75
3	0:30:00	0.39	1100.39	5685.48
3	0:35:00	0.39	1100.39	5633.59
3	0:40:00	0.38	1100.38	5582.09
3	0:45:00	0.38	1100.38	5530.98
3	0:50:00	0.38	1100.38	5480.25
3	0:55:00	0.37	1100.37	5429.92
3	1:00:00	0.37	1100.37	5379.97
3	1:05:00	0.37	1100.37	5330.41
3	1:10:00	0.36	1100.36	5281.25
3	1:15:00	0.36	1100.36	5232.47
3	1:20:00	0.36	1100.36	5184.07
3	1:25:00	0.35	1100.35	5136.07
3	1:30:00	0.35	1100.35	5088.46
3	1:35:00	0.35	1100.35	5041.23
3	1:40:00	0.34	1100.34	4994.39
3	1:45:00	0.34	1100.34	4947.95
3	1:50:00	0.34	1100.34	4901.89
3	1:55:00	0.33	1100.33	4856.21
3	2:00:00	0.33	1100.33	4810.93
3	2:05:00	0.33	1100.33	4766.04
3	2:10:00	0.33	1100.33	4721.53
3	2:15:00	0.32	1100.32	4677.42
3	2:20:00	0.32	1100.32	4633.69
3	2:25:00	0.32	1100.32	4590.35
3	2:30:00	0.31	1100.31	4547.4
3	2:35:00	0.31	1100.31	4504.84
3	2:40:00	0.31	1100.31	4462.67
3	2:45:00	0.3	1100.3	4420.88
3	2:50:00	0.3	1100.3	4379.49
3	2:55:00	0.3	1100.3	4338.64
3	3:00:00	0.3	1100.3	4298.35
3	3:05:00	0.29	1100.29	4258.62
3	3:10:00	0.29	1100.29	4219.44
3	3:15:00	0.29	1100.29	4180.8
3	3:20:00	0.29	1100.29	4142.69
3	3:25:00	0.28	1100.28	4105.1
3	3:30:00	0.28	1100.28	4068.02
3	3:35:00	0.28	1100.28	4031.43
3	3:40:00	0.28	1100.28	3995.34
3	3:45:00	0.27	1100.27	3959.73
3	3:50:00	0.27	1100.27	3924.6
3	3:55:00	0.27	1100.27	3889.93
3	4:00:00	0.27	1100.27	3855.72
3	4:05:00	0.26	1100.26	3821.96
3	4:10:00	0.26	1100.26	3788.64
3	4:15:00	0.26	1100.26	3755.76
3	4:20:00	0.26	1100.26	3723.3
3	4:25:00	0.25	1100.25	3691.26
3	4:30:00	0.25	1100.25	3659.63
3	4:35:00	0.25	1100.25	3628.41
3	4:40:00	0.25	1100.25	3597.58
3	4:45:00	0.25	1100.25	3567.15
3	4:50:00	0.24	1100.24	3537.1
3	4:55:00	0.24	1100.24	3507.43

3	5:00:00	0.24	1100.24	3478.13
3	5:05:00	0.24	1100.24	3449.2
3	5:10:00	0.24	1100.24	3420.63
3	5:15:00	0.23	1100.23	3392.41
3	5:20:00	0.23	1100.23	3364.54
3	5:25:00	0.23	1100.23	3337.01
3	5:30:00	0.23	1100.23	3309.82
3	5:35:00	0.23	1100.23	3282.96
3	5:40:00	0.22	1100.22	3256.42
3	5:45:00	0.22	1100.22	3230.21
3	5:50:00	0.22	1100.22	3204.31
3	5:55:00	0.22	1100.22	3178.72
3	6:00:00	0.22	1100.22	3153.44
3	6:05:00	0.22	1100.22	3128.46
3	6:10:00	0.21	1100.21	3103.77
3	6:15:00	0.21	1100.21	3079.37
3	6:20:00	0.21	1100.21	3055.26
3	6:25:00	0.21	1100.21	3031.44
3	6:30:00	0.21	1100.21	3007.89
3	6:35:00	0.21	1100.21	2984.61
3	6:40:00	0.2	1100.2	2961.61
3	6:45:00	0.2	1100.2	2938.87
3	6:50:00	0.2	1100.2	2916.39
3	6:55:00	0.2	1100.2	2894.16
3	7:00:00	0.2	1100.2	2872.19
3	7:05:00	0.2	1100.2	2850.47
3	7:10:00	0.19	1100.19	2829
3	7:15:00	0.19	1100.19	2807.77
3	7:20:00	0.19	1100.19	2786.77
3	7:25:00	0.19	1100.19	2766.01
3	7:30:00	0.19	1100.19	2745.48
3	7:35:00	0.19	1100.19	2725.18
3	7:40:00	0.19	1100.19	2705.11
3	7:45:00	0.18	1100.18	2685.25
3	7:50:00	0.18	1100.18	2665.61
3	7:55:00	0.18	1100.18	2646.19
3	8:00:00	0.18	1100.18	2626.98
3	8:05:00	0.18	1100.18	2607.98
3	8:10:00	0.18	1100.18	2589.18
3	8:15:00	0.18	1100.18	2570.59
3	8:20:00	0.18	1100.18	2552.19
3	8:25:00	0.17	1100.17	2533.99
3	8:30:00	0.17	1100.17	2515.99
3	8:35:00	0.17	1100.17	2498.18
3	8:40:00	0.17	1100.17	2480.55
3	8:45:00	0.17	1100.17	2463.11
3	8:50:00	0.17	1100.17	2445.86
3	8:55:00	0.17	1100.17	2428.79
3	9:00:00	0.17	1100.17	2411.89
3	9:05:00	0.16	1100.16	2395.17
3	9:10:00	0.16	1100.16	2378.62
3	9:15:00	0.16	1100.16	2362.25
3	9:20:00	0.16	1100.16	2346.04
3	9:25:00	0.16	1100.16	2330
3	9:30:00	0.16	1100.16	2314.12
3	9:35:00	0.16	1100.16	2298.41
3	9:40:00	0.16	1100.16	2282.85
3	9:45:00	0.16	1100.16	2267.46
3	9:50:00	0.16	1100.16	2252.21
3	9:55:00	0.15	1100.15	2237.12
3	10:00:00	0.15	1100.15	2222.19
3	10:05:00	0.15	1100.15	2207.4
3	10:10:00	0.15	1100.15	2192.75
3	10:15:00	0.15	1100.15	2178.26

3	10:20:00	0.15	1100.15	2163.91
3	10:25:00	0.15	1100.15	2149.69
3	10:30:00	0.15	1100.15	2135.62
3	10:35:00	0.15	1100.15	2121.69
3	10:40:00	0.15	1100.15	2107.89
3	10:45:00	0.14	1100.14	2094.23
3	10:50:00	0.14	1100.14	2080.69
3	10:55:00	0.14	1100.14	2067.29
3	11:00:00	0.14	1100.14	2054.02
3	11:05:00	0.14	1100.14	2040.88
3	11:10:00	0.14	1100.14	2027.86
3	11:15:00	0.14	1100.14	2014.96
3	11:20:00	0.14	1100.14	2002.19
3	11:25:00	0.14	1100.14	1989.54
3	11:30:00	0.14	1100.14	1977.01
3	11:35:00	0.14	1100.14	1964.6
3	11:40:00	0.13	1100.13	1952.3
3	11:45:00	0.13	1100.13	1940.12
3	11:50:00	0.13	1100.13	1928.05
3	11:55:00	0.13	1100.13	1916.1
3	12:00:00	0.13	1100.13	1904.26
3	12:05:00	0.13	1100.13	1892.52
3	12:10:00	0.13	1100.13	1880.89
3	12:15:00	0.13	1100.13	1869.37
3	12:20:00	0.13	1100.13	1857.96
3	12:25:00	0.13	1100.13	1846.65
3	12:30:00	0.13	1100.13	1835.44
3	12:35:00	0.13	1100.13	1824.34
3	12:40:00	0.12	1100.12	1813.33
3	12:45:00	0.12	1100.12	1802.43
3	12:50:00	0.12	1100.12	1791.62
3	12:55:00	0.12	1100.12	1780.91
3	13:00:00	0.12	1100.12	1770.3
3	13:05:00	0.12	1100.12	1759.78
3	13:10:00	0.12	1100.12	1749.35
3	13:15:00	0.12	1100.12	1739.02
3	13:20:00	0.12	1100.12	1728.77
3	13:25:00	0.12	1100.12	1718.62
3	13:30:00	0.12	1100.12	1708.56
3	13:35:00	0.12	1100.12	1698.58
3	13:40:00	0.12	1100.12	1688.7
3	13:45:00	0.12	1100.12	1678.9
3	13:50:00	0.11	1100.11	1669.18
3	13:55:00	0.11	1100.11	1659.55
3	14:00:00	0.11	1100.11	1650
3	14:05:00	0.11	1100.11	1640.53
3	14:10:00	0.11	1100.11	1631.14
3	14:15:00	0.11	1100.11	1621.84
3	14:20:00	0.11	1100.11	1612.61
3	14:25:00	0.11	1100.11	1603.47
3	14:30:00	0.11	1100.11	1594.4
3	14:35:00	0.11	1100.11	1585.4
3	14:40:00	0.11	1100.11	1576.49
3	14:45:00	0.11	1100.11	1567.64
3	14:50:00	0.11	1100.11	1558.88
3	14:55:00	0.11	1100.11	1550.18
3	15:00:00	0.11	1100.11	1541.56
3	15:05:00	0.11	1100.11	1533.01
3	15:10:00	0.1	1100.1	1524.53
3	15:15:00	0.1	1100.1	1516.12
3	15:20:00	0.1	1100.1	1507.78
3	15:25:00	0.1	1100.1	1499.51
3	15:30:00	0.1	1100.1	1491.31
3	15:35:00	0.1	1100.1	1483.17

3	15:40:00	0.1	1100.1	1475.1
3	15:45:00	0.1	1100.1	1467.1
3	15:50:00	0.1	1100.1	1459.16
3	15:55:00	0.1	1100.1	1451.29
3	16:00:00	0.1	1100.1	1443.47
3	16:05:00	0.1	1100.1	1435.73
3	16:10:00	0.1	1100.1	1428.04
3	16:15:00	0.1	1100.1	1420.42
3	16:20:00	0.1	1100.1	1412.85
3	16:25:00	0.1	1100.1	1405.35
3	16:30:00	0.1	1100.1	1397.91
3	16:35:00	0.1	1100.1	1390.52
3	16:40:00	0.1	1100.1	1383.2
3	16:45:00	0.09	1100.09	1375.93
3	16:50:00	0.09	1100.09	1368.72
3	16:55:00	0.09	1100.09	1361.56
3	17:00:00	0.09	1100.09	1354.46
3	17:05:00	0.09	1100.09	1347.42
3	17:10:00	0.09	1100.09	1340.43
3	17:15:00	0.09	1100.09	1333.5
3	17:20:00	0.09	1100.09	1326.62
3	17:25:00	0.09	1100.09	1319.79
3	17:30:00	0.09	1100.09	1313.02
3	17:35:00	0.09	1100.09	1306.29
3	17:40:00	0.09	1100.09	1299.62
3	17:45:00	0.09	1100.09	1293
3	17:50:00	0.09	1100.09	1286.43
3	17:55:00	0.09	1100.09	1279.91
3	18:00:00	0.09	1100.09	1273.44
3	18:05:00	0.09	1100.09	1267.02
3	18:10:00	0.09	1100.09	1260.65
3	18:15:00	0.09	1100.09	1254.32
3	18:20:00	0.09	1100.09	1248.05
3	18:25:00	0.09	1100.09	1241.82
3	18:30:00	0.09	1100.09	1235.63
3	18:35:00	0.08	1100.08	1229.49
3	18:40:00	0.08	1100.08	1223.4
3	18:45:00	0.08	1100.08	1217.36
3	18:50:00	0.08	1100.08	1211.35
3	18:55:00	0.08	1100.08	1205.4
3	19:00:00	0.08	1100.08	1199.48
3	19:05:00	0.08	1100.08	1193.61
3	19:10:00	0.08	1100.08	1187.78
3	19:15:00	0.08	1100.08	1182
3	19:20:00	0.08	1100.08	1176.26
3	19:25:00	0.08	1100.08	1170.55
3	19:30:00	0.08	1100.08	1164.9
3	19:35:00	0.08	1100.08	1159.28
3	19:40:00	0.08	1100.08	1153.7
3	19:45:00	0.08	1100.08	1148.16
3	19:50:00	0.08	1100.08	1142.66
3	19:55:00	0.08	1100.08	1137.2
3	20:00:00	0.08	1100.08	1131.78
3	20:05:00	0.08	1100.08	1126.4
3	20:10:00	0.08	1100.08	1121.06
3	20:15:00	0.08	1100.08	1115.76
3	20:20:00	0.08	1100.08	1110.49
3	20:25:00	0.08	1100.08	1105.26
3	20:30:00	0.08	1100.08	1100.06
3	20:35:00	0.08	1100.08	1094.91
3	20:40:00	0.08	1100.07	1089.79
3	20:45:00	0.07	1100.07	1084.7
3	20:50:00	0.07	1100.07	1079.65
3	20:55:00	0.07	1100.07	1074.64

3	21:00:00	0.07	1100.07	1069.66
3	21:05:00	0.07	1100.07	1064.72
3	21:10:00	0.07	1100.07	1059.81
3	21:15:00	0.07	1100.07	1054.93
3	21:20:00	0.07	1100.07	1050.09
3	21:25:00	0.07	1100.07	1045.28
3	21:30:00	0.07	1100.07	1040.5
3	21:35:00	0.07	1100.07	1035.76
3	21:40:00	0.07	1100.07	1031.05
3	21:45:00	0.07	1100.07	1026.37
3	21:50:00	0.07	1100.07	1021.72
3	21:55:00	0.07	1100.07	1017.1
3	22:00:00	0.07	1100.07	1012.52
3	22:05:00	0.07	1100.07	1007.96
3	22:10:00	0.07	1100.07	1003.44
3	22:15:00	0.07	1100.07	998.95
3	22:20:00	0.07	1100.07	994.48
3	22:25:00	0.07	1100.07	990.05
3	22:30:00	0.07	1100.07	985.65
3	22:35:00	0.07	1100.07	981.27
3	22:40:00	0.07	1100.07	976.93
3	22:45:00	0.07	1100.07	972.61
3	22:50:00	0.07	1100.07	968.33
3	22:55:00	0.07	1100.07	964.07
3	23:00:00	0.07	1100.07	959.83
3	23:05:00	0.07	1100.07	955.63
3	23:10:00	0.07	1100.07	951.46
3	23:15:00	0.07	1100.07	947.31
3	23:20:00	0.06	1100.06	943.19
3	23:25:00	0.06	1100.06	939.09
3	23:30:00	0.06	1100.06	935.02
3	23:35:00	0.06	1100.06	930.98
3	23:40:00	0.06	1100.06	926.97
3	23:45:00	0.06	1100.06	922.98
3	23:50:00	0.06	1100.06	919.01
3	23:55:00	0.06	1100.06	915.07
3	0:00:00	0.06	1100.06	911.16

ATTACHMENT 5

Soil Loss Equation



RUSLE2 Worksheet Erosion Calculation Record

AT CLOVER, GOOD GRASS

Info:

Inputs:

Owner name	Location
WCA	USA\Tennessee\Knox County
	--

Location	Soil	T value	Slope length (horiz)	Avg. slope steepness, %
USA\Tennessee\Knox County	Knox County, Tennessee\SwC Swafford silt loam, 5 to 12 percent slopes\Swafford Silt loam 80%	5.0	100	33

Outputs:

Base management	Description	Contouring	Strips / barriers	Diversion/terrace, sediment basin	Soil loss erod. portion, t/ac/yr	Soil detachment, t/ac/yr	Cons. plan. soil loss, t/ac/yr	Sed. delivery, t/ac/yr
temp\Annual Seeding - Trail 1		default	(none)	(none)	1.8	1.8	1.8	1.8

RUSLE2 Worksheet Erosion Calculation Record

PHASE TO CLOSE, PUNE TO NO GRASS

Info:

Inputs:

Owner name	Location
WCA	USA\Tennessee\Knox County
	--

Location	Soil	T value	Slope length (horiz)	Avg. slope steepness, %
USA\Tennessee\Knox County	Knox County, Tennessee\SwC Swafford silt loam, 5 to 12 percent slopes\Swafford Silt loam 80%	5.0	100	33

Outputs:

Base management	Description	Contouring	Strips / barriers	Diversion/terrace, sediment basin	Soil loss erod. portion, t/ac/yr	Soil detachment, t/ac/yr	Cons. plan. soil loss, t/ac/yr	Sed. delivery, t/ac/yr
temp\Bare Ground Initial Seeding		default	(none)	(none)	14	14	14	14

APPENDIX C

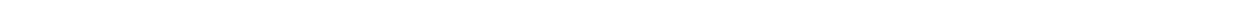

PCSTABL5M CALCULATIONS

Performed By: APM

Reviewed By: RHI

Geotechnical Soil Properties

The geotechnical soil properties used in the slope stability analysis are based on the following reports, published website typical values for soils, and our experience with similar soil materials in the area:

- Revised Report of Hydrogeologic Evaluation by Law Engineering for Yarnell Road Site, dated November 4, 1993
- Yarnell Road Class III/IV Demolition Landfill, Part II Permit Application Major Modification DML – 47 – 0069, by Quantum Environmental & Engineering Services, LLC, dated March 4, 2005
- <http://www.geotechdata.info/parameter/angle-of-friction.html>
- <http://www.geotechdata.info/parameter/cohesion/html>

Based on the two soil borings (SS1 and SS2 located within Phase F-2) obtained from Law Engineering's report - Revised Hydrogeologic Report dated Nov 4, 1993, the overburden soil in Phase F-2 consists mainly a Fullerton cherty silt loam to silty clay loam, which is a very stiff, high plasticity silty soil, as shown in soil boring SS1 (classified as MH soil per USCS). A small portion of the overburden soil is a Bolton silt loam, which is described as a moderately stiff high plasticity silty clay, as shown in soil boring SS2 (classified as CH soil per USCS). MH soil was taken at 30-32' below ground surface and has 51% passing No. 200 sieve. The CH soil was taken at 8-10 feet below ground surface and has 67% passing No. 200 sieve.

No SPT values were performed. The report also presents Atterberg limits values as follow:

- SS1 - Silty clay loam: LL=78, PL=39, PI = 39; a MH soil
- SS2 - Silt loam: LL=66, PL=30, PI = 36; a CH soil

The two hydraulic conductivity testing on the SS-series soil samples have an average unit weight of 113 pcf. In addition, three Standard Proctor tests were performed on soil samples taken from the site, indicating that the local soils have an average unit weight of 121 pcf.

Hence, it is assumed that a 120 pcf should be used for the foundation/separation soil layer above the bedrock and a 115 pcf be used for the final soil cap layer.

For the shear strength of the foundation soil layer and the final soil cap, it is appropriate to use any published data or our experience with similar soil materials for typical shear strength parameters.

Based on a published website identified above (www.geotechdata.info), the attached tables give the following typical average values for consideration:

- Inorganic silts of high plasticity soil (MH) - a friction angle ranging from 23 to 33, or an average of 28 degrees
- Inorganic clay of high plastic soil (CH) - a friction angle ranging from 17 to 31, or an average of 24 degrees

- Silty clay loam (CH) gives a friction angle ranging from 18 to 32, or an average of 25 degrees.
- Inorganic silts and clays of high plasticity soil - a cohesion ranging from 10 to 25 kPa, or 17.5 kPa (365 psf)

For the MH/CH foundation/separation soil layer, it should have a conservative average friction angle of 25 degrees and a cohesion of 350 psf, to be used for the slope stability analysis. Note that in the 2005 QE Report, a slightly lower friction angle of 22 degrees but a slightly higher cohesion of 400 psf were used in their analysis, respectively.

The Quantum Environmental & Engineering in 2005 report presents the unit weight and shear strength parameters of the C&D waste as follow:

- C&D waste – The unit weight is 63 pcf. This value could be higher but is acceptable for this analysis since it is not as critical as other input shear strength parameters
- C&D Waste - Friction angle and cohesion = 35 degrees and 0psf, respectively. Since it is a C&D material, it is expected the waste will have some cohesion but we used a conservative value of 0psf.
- Bedrock unit weight and shear strengths – The unit weight of 155 pcf could be lower but is acceptable. A friction angle of 45 degrees was used.

The geotechnical shear strength parameters and unit weight of each layer used in the stability analyses are summarized in Table 1.

The thickness of the foundation/separation soil layer above the bedrock is assumed to be at least 10 feet, based on the JB as-built drawing presented in May 2017.

**Table 1
Summary of Geotechnical Soil Shear Strength Properties for Stability Modeling**

Layer	Unit Weight (moist)	Unit Weight (saturated)	Shear Strength	Angle of Internal Friction	Reference
	(pcf)	(pcf)	(psf)	(degrees)	
Final Soil Cap	115	115	200	26	Estimate based on experience
C&D Waste	63	63	0	35	2005 QE Report
Foundation/Separation Soil Layer	120	120	200	33	Geotechdata.info
Bedrock	155	155	200	45	2005 QE Report

Attachments



LEGEND

- Bg - Bolton silt loam
- Fe,Fi - Fullerton cherty silt loam
- Fi - Fullerton cherty silty clay loam
- Gg - Sequoia/Montevallo gullied soils
- Ha - Hamblen fine sandy loam
- Md - Montevallo shaly silt loam

SOURCE: USDA SOIL SURVEY OF KNOX COUNTY, LOVELL QUADRANGLE



LAW ENGINEERING
 GEOTECHNICAL, ENVIRONMENTAL
 & CONSTRUCTION MATERIALS
 CONSULTANTS
 1725 LOUISVILLE DRIVE • KNOXVILLE, TENNESSEE 37921 • 615-588-8544

FIGURE 4: SOIL MAP
FARRAGUT EXCAVATING COMPANY
YARNELL ROAD SITE
KNOX COUNTY, TENNESSEE

Job Number
K-88172E

Scale
 0 2,000'

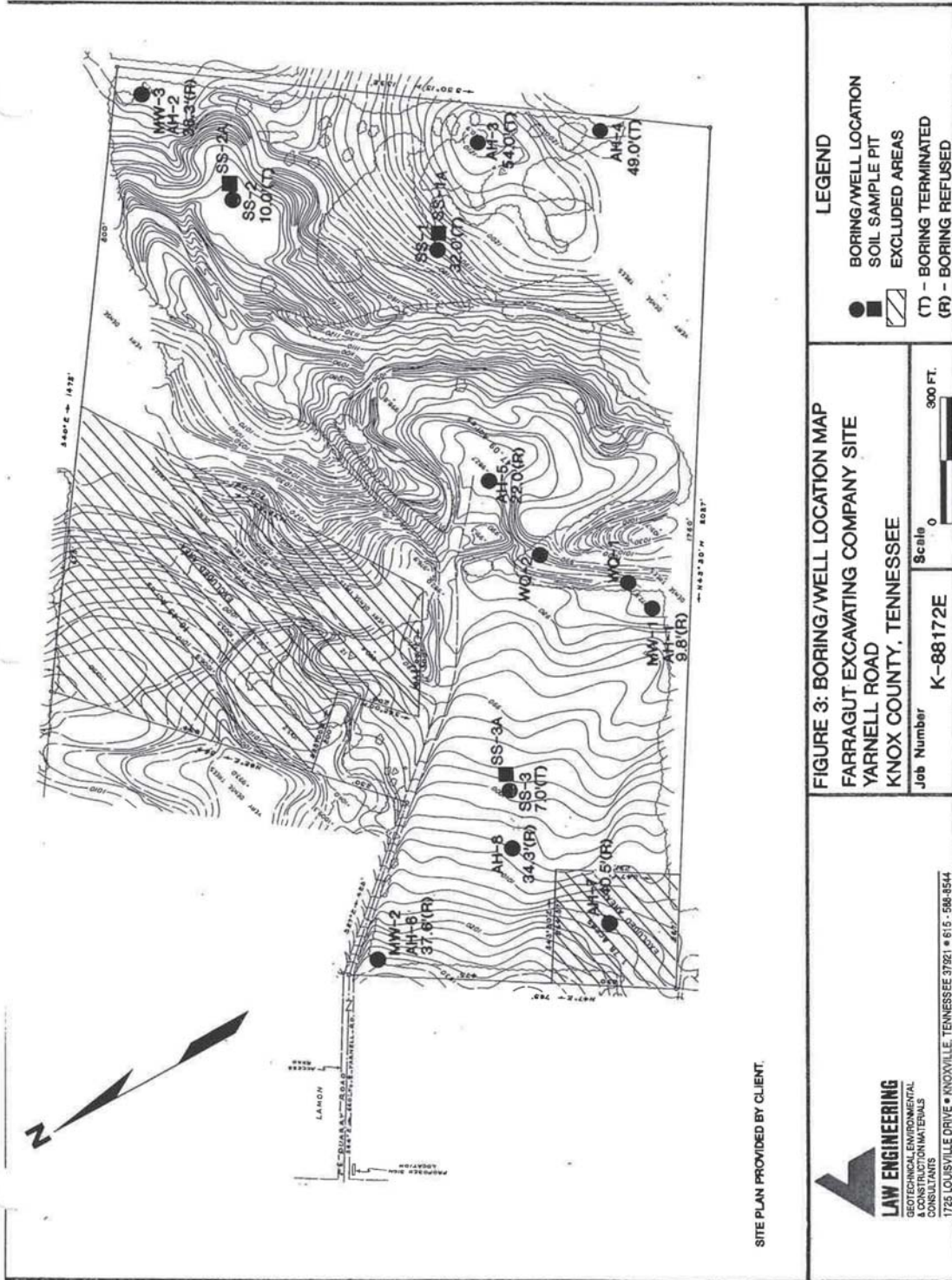

SITE PLAN PROVIDED BY CLIENT.

FIGURE 3: BORING/WELL LOCATION MAP
FARRAGUT EXCAVATING COMPANY SITE
YARNELL ROAD
KNOX COUNTY, TENNESSEE

LAW ENGINEERING
 REGISTERED PROFESSIONAL ENGINEERS
 CONSULTANTS
 1725 LOUISVILLE DRIVE • KNOXVILLE, TENNESSEE 37921 • 615-588-8544

Job Number **K-88172E**
 Scale **0** **300 FT.**

- LEGEND**
- BORING/WELL LOCATION
 - SOIL SAMPLE PIT
 - ▨ EXCLUDED AREAS
 - (T) - BORING TERMINATED
 - (R) - BORING REFUSED

DEPTH (FT.)	DESCRIPTION	ELEVATION (FT.)	● PENETRATION - BLOWS/FOOT										
			0	10	20	30	40	60	80	100			
0.0	CLAY, BROWN TO REDDISH BROWN, SILTY, SLIGHTLY TO MODERATELY MOIST. VERY STIFF.												
30.0													
	UNDISTURBED SAMPLE ATTEMPT												
32.0	BORING TERMINATED AT 32.0 FEET												

REMARKS:

SEE KEY SHEET FOR EXPLANATION OF
SYMBOLS AND ABBREVIATIONS USED ABOVE

TEST BORING RECORD	
BORING NUMBER	SS-1
DATE DRILLED	February 11, 1993
PROJECT NUMBER	K-88172
PROJECT	FARRAGUT EXCAVATING
PAGE 1 OF 1	
 LAW ENGINEERING	

DEPTH (FT.)	DESCRIPTION	ELEVATION (FT.)	● PENETRATION - BLOWS/FOOT																	
			0	10	20	30	40	60	80	100										
0.0	CLAY, RED-BROWN, SILTY, MOIST. MODERATELY STIFF.																			
8.0																				
10.0	UNDISTURBED SAMPLE ATTEMPT																			
	BORING TERMINATED AT 10.0 FEET																			

REMARKS:

TEST BORING RECORD	
BORING NUMBER	SS-2
DATE DRILLED	February 11, 1993
PROJECT NUMBER	K-88172
PROJECT	FARRAGUT EXCAVATING
PAGE 1 OF 1	
▲ LAW ENGINEERING	

SEE KEY SHEET FOR EXPLANATION OF SYMBOLS AND ABBREVIATIONS USED ABOVE

TDSWM guidance document. Therefore, we conclude the clayey soils underlying the project site are not typically susceptible to liquefaction.

2. Global and Local Stability of the Landfill Slopes Under Seismic Loading

A global and local stability analysis was performed to provide data to estimate potential failure in the landfill during the design earthquake. For this analysis, the design earthquake is represented by the maximum horizontal acceleration (MHA). The MHA is the acceleration with a 90 percent probability of not being exceeded in 250 years. The estimated MHA value for the landfill is 0.22g. This value was taken from the USGS Map of Maximum Horizontal Accelerations contained in the TDSWM guidance document.

The computer program PCSTABL5M was used to perform a pseudostatic seismic analysis to obtain the yield acceleration for the critical landfill section based on slope geometry. The slope configurations selected for the analysis were the cross-sections through Phase F-1 and F-2 (Sheet S-13, Station E 9+00). These slopes were selected because they were the highest in the landfill and, therefore, judged to be most critical.

The foundation soil and ground water conditions were based on boring data collected during the hydrogeological assessment. Strength parameters for the foundation soils and the solid waste refuse were estimated based on empirical correlations and published data. The slope stability analysis was performed using the following consolidated-undrained parameters for the new proposed waste and foundation (overburden) soil:

Material	Cohesion (psf)	Friction Angle (degrees)	Moist Density (pcf)
Proposed C and D Waste	350	30	63
Foundation Soils	400	22	110

Based on our analysis, a circular general shear failure initiating slightly above the toe of Phase F-1 and extending through the waste eventually surfaces at the northern boundary of Phase F-2 was the most critical surface interface (refer to the attached drawing).

For the maximum slope of 3(H):1(V) and considering the parameters tabulated above, the calculated factor of safety is 1.724 (minimum required Factor of Safety= 1.0) with an earthquake loading and a dewatered waste profile. Therefore, we expect the overall (global and local) stability of the landfill will be adequate during the design seismic event.



MH soils are generally inorganic, fine silty soils and elastic silts, CH soils are inorganic or "fat" clays, and ML and CL soils are generally inorganic silty clays and clays of low plasticity. Results of the soil classifications tests are summarized in Table 1. Copies of the laboratory work sheets and a copy of the Cassagrande Soil Plasticity Chart are attached.

	SS-1A	SS-2A	SS-3A
Sample Depth (Feet)	5 - 14	4 - 5	3 - 5
Moisture Content (%)	47.6	38.7	46.0
Liquid Limit	78	66	45
Plastic Limit	39	30	28
Plasticity Index	39	36	17
USCS Type	MH	CH	ML/CL

4.3.3 Grain Size Analyses: Three composite soil samples, one from each of the three test pits (SS-1A, SS-2A and SS-3A), were analyzed in general accordance with the applicable procedures for sieve analysis of ASTM Designation D-422. Copies of the Soil Classification Analysis reports for each sample are attached.



Home About Database Testing Monitoring Parameters GeoDirectory GeoSoftware

Connect with us:



NEWSLETTER

Subscribe to our free monthly newsletter.

Email:



Need Geotechnical Equipment? Request a quote



LATEST NEWS

New entry to Geotechnical Business Directory [more](#)

True Triaxial updated [more](#)

Vibrating Wire load cell updated [more](#)

Proctor test updated [more](#)

CERCHAR test updated [more](#)

Soil friction angle

Geotechdata.info - Updated 14.12.2013

Soil friction angle is a shear strength parameter of soils. Its definition is derived from the Mohr-Coulomb failure criterion and it is used to describe the friction shear resistance of soils together with the normal effective stress.

In the stress plane of Shear stress-effective normal stress, the soil friction angle is the angle of inclination with respect to the horizontal axis of the Mohr-Coulomb shear resistance line.

Typical values of soil friction angle for different soils according to USCS

Some typical values of soil friction angle are given below for different USCS soil types at normally consolidated condition unless otherwise stated. These values should be used only as guideline for geotechnical problems; however, specific condition of each engineering problem often needs to be considered for an appropriate choice of geotechnical parameters.

Description	USCS	Soil friction angle [°]		Specific value	Reference
		min	max		
Well graded gravel, sandy gravel, with little or no fines	GW	33	40		[1],[2].
Poorly graded gravel, sandy gravel, with little or no fines	GP	32	44		[1].
Sandy gravels - Loose	(GW, GP)			35	[3 cited in 6]
Sandy gravels - Dense	(GW, GP)			50	[3 cited in 6]
Silty gravels, silty sandy gravels	GM	30	40		[1].
Clayey gravels, clayey sandy gravels	GC	28	35		[1].
Well graded sands, gravelly sands, with little or no fines	SW	33	43		[1].
Well-graded clean sand, gravelly sands - Compacted	SW	-	-	38	[3 cited in 6]
Well-graded sand, angular grains - Loose	(SW)			33	[3 cited in 6]
Well-graded sand, angular grains - Dense	(SW)			45	[3 cited in 6]
Poorly graded sands, gravelly sands, with little or no fines	SP	30	39		[1], [2].
Poorly-graded clean sand - Compacted	SP	-	-	37	[3 cited in 6]
Uniform sand, round grains - Loose	(SP)			27	[3 cited in 6]
Uniform sand, round grains - Dense	(SP)			34	[3 cited in 6]
Sand	SW, SP	37	38		[7].
Loose sand	(SW, SP)	29	30		[5 cited in 6]
Medium sand	(SW, SP)	30	36		[5 cited in 6]
Dense sand	(SW, SP)	36	41		[5 cited in 6]
Silty sands	SM	32	35		[1].
Silty clays, sand-silt mix - Compacted	SM	-	-	34	[3 cited in 6]
Silty sand - Loose	SM	27	33		[3 cited in 6]
Silty sand - Dense	SM	30	34		[3 cited in 6]
Clayey sands	SC	30	40		[1].

Sponsoring - Join

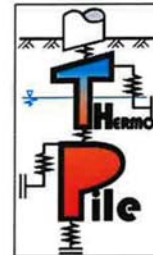

Calvee sands, sandy-clay mix - compacted	SC			31	[3 cited in 6]
Loamy sand, sandy clay Loam	SM, SC	31	34		[7].
Inorganic silts, silty or clayey fine sands, with slight plasticity	ML	27	41		[1].
Inorganic silt - Loose	ML	27	30		[3 cited in 6]
Inorganic silt - Dense	ML	30	35		[3 cited in 6]
Inorganic clays, silty clays, sandy clays of low plasticity	CL	27	35		[1].
Clays of low plasticity - compacted	CL			28	[3 cited in 6]
Organic silts and organic silty clays of low plasticity	OL	22	32		[1].
Inorganic silts of high plasticity	MH	23	33		[1].
Clayey silts - compacted	MH			25	[3 cited in 6]
Silts and clayey silts - compacted	ML			32	[3 cited in 6]
Inorganic clays of high plasticity	CH	17	31		[1].
Clays of high plasticity - compacted	CH			19	[3 cited in 6]
Organic clays of high plasticity	OH	17	35		[1].
Loam	ML, OL, MH, OH	28	32		[7].
Silt Loam	ML, OL, MH, OH	25	32		[7].
Clay Loam, Silty Clay Loam	ML, OL, CL, MH, OH, CH	18	32		[7].
Silty clay	OL, CL, OH, CH	18	32		[7].
Clay	CL, CH, OH, OL	18	28		[7].
Peat and other highly organic soils	Pt	0	10		[2].

Correlation between SPT-N value, friction angle, and relative density

Correlation between SPT-N value and friction angle and Relative density (Meyerhoff 1956)

SPT N3 [Blows/0.3 m - 1 ft]	Soil packing	Relative Density [%]	Friction angle [°]
< 4	Very loose	< 20	< 30
4 -10	Loose	20 - 40	30 - 35
10 - 30	Compact	40 - 60	35 - 40
30 - 50	Dense	60 - 80	40 - 45
> 50	Very Dense	> 80	> 45

REFERENCES

1. Swiss Standard SN 670 010b, Characteristic Coefficients of soils, Association of Swiss Road and Traffic Engineers
2. JON W. KOLOSKI, SIGMUND D. SCHWARZ, and DONALD W. TUBBS, Geotechnical Properties of Geologic Materials, Engineering Geology in Washington, Volume 1, Washington Division of Geology and Earth Resources Bulletin 78, 1989. Link
3. Carter, M. and Bentley, S. (1991). Correlations of soil properties. Penetech Press Publishers, London.
4. Meyerhof, G. (1956). Penetration tests and bearing capacity of cohesionless soils. J Soils Mechanics and Foundation Division ASCE, 82(SM1).
5. Peck, R., Hanson, W., and Thornburn, T. (1974). Foundation Engineering Handbook. Wiley, London.
6. Obrzud R. & Truty, A. THE HARDENING SOIL MODEL - A PRACTICAL GUIDEBOOK Z Soil.PC 100701 report, revised 31.01.2012
7. Minnesota Department of Transportation, Pavement Design, 2007



Home About Database Testing Monitoring Parameters GeoDirectory GeoSoftware

Connect with us:



NEWSLETTER

Subscribe to our free monthly newsletter.

Email:



Need Geotechnical Equipment? Request a quote



LATEST NEWS

New entry to Geotechnical Business Directory [more](#)

True Triaxial updated [more](#)

Vibrating Wire load cell updated [more](#)

Proctor test updated [more](#)

CERCHAR test updated [more](#)

Soil Cohesion

Geotechdata.info - Updated 31.10.2014

The cohesion is a term used in describing the shear strength soils. Its definition is mainly derived from the Mohr-Coulomb failure criterion and it is used to describe the non-frictional part of the shear resistance which is independent of the normal stress. In the stress plane of Shear stress-effective normal stress, the soil cohesion is the intercept on the shear axis of the Mohr-Coulomb shear resistance line

Typical values of soil cohesion for different soils

Some typical values of soil cohesion are given below for different soil types. The soil cohesion depends strongly on the consistence, packing, and saturation condition. The values given below correspond to normally consolidated condition unless otherwise stated. These values should be used only as guideline for geotechnical problems; however, specific condition of each engineering problem often needs to be considered for an appropriate choice of geotechnical parameters.

Description	USCS	Cohesion [kPa]			Reference
		min	max	Specific value	
Well graded gravel, sandy gravel, with little or no fines	GW	-	-	0	[1],[2],[3].
Poorly graded gravel, sandy gravel, with little or no fines	GP	-	-	0	[1],[2], [3].
Silty gravels, silty sandy gravels	GM	-	-	0	[1].
Clayey gravels, clayey sandy gravels	GC	-	-	20	[1].
Well graded sands, gravelly sands, with little or no fines	SW	-	-	0	[1],[2], [3].
Poorly graded sands, gravelly sands, with little or no fines	SP	-	-	0	[1],[2], [3].
Silty sands	SM	-	-	22	[1].
Silty sands - Saturated compacted	SM	-	-	50	[3].
Silty sands - Compacted	SM	-	-	20	[3].
Clayey sands	SC	-	-	5	[1].
Clayey sands - Compacted	SC	-	-	74	[3].
Clayey sands -Saturated compacted	SC	-	-	11	[3].
Loamy sand, sandy clay Loam - compacted	SM, SC	50	75		[2].
Loamy sand, sandy clay Loam - saturated	SM, SC	10	20		[2].
Sand silt clay with slightly plastic fines - compacted	SM, SC	-	-	50	[3].
Sand silt clay with slightly plastic fines - saturated compacted	SM, SC	-	-	14	[3].
Inorganic silts, silty or clayey fine sands, with slight plasticity	ML	-	-	7	[1].
Inorganic silts and clayey silts - compacted	ML	-	-	67	[3].
Inorganic silts and clayey silts - saturated compacted	ML	-	-	9	[3].
Inorganic clays, silty clays, sandy clays of low plasticity	CL	-	-	4	[1].
Inorganic clays, silty clays, sandy clays of low plasticity - compacted	CL	-	-	86	[3].
Inorganic clays, silty clays, sandy clays of low plasticity - saturated compacted	CL	-	-	13	[3].
	ML-CL	-	-	65	[3].

Sponsoring - Join



Mixture if inorganic silt and clay - compacted					
Mixture if inorganic silt and clay - saturated compacted	ML-CL	-	-	22	[3].
Organic silts and organic silty clays of low plasticity	OL	-	-	5	[1].
→ Inorganic silts of high plasticity - compact	MH	-	-	10	[1].
Inorganic silts of high plasticity - saturated compacted	MH	-	-	72	[3].
→ Inorganic silts of high plasticity	MH	-	-	20	[3].
Inorganic clays of high plasticity	CH	-	-	25	[1].
Inorganic clays of high plasticity - compacted	CH	-	-	103	[3].
Inorganic clays of high plasticity - saturated compacted	CH	-	-	11	[3].
Organic clays of high plasticity	OH	-	-	10	[1].
Loam - Compacted	ML, OL, MH, OH	60	90		[2].
Loam - Saturated	ML, OL, MH, OH	10	20		[2].
Silt Loam - Compacted	ML, OL, MH, OH	60	90		[2].
Silt Loam - Saturated	ML, OL, MH, OH	10	20		[2].
Clay Loam, Silty Clay Loam - Compacted	ML, OL, CL, MH, OH, CH	60	105		[2].
Clay Loam, Silty Clay Loam - Saturated	ML, OL, CL, MH, OH, CH	10	20		[2].
Silty clay, clay - compacted	OL, CL, OH, CH	90	105		[2].
Silty clay, clay - saturated	OL, CL, OH, CH	10	20		[2].
Peat and other highly organic soils	Pt	-	-		

200 p_{st}

500 p_{st}

REFERENCES

1. Swiss Standard SN 670 010b, Characteristic Coefficients of soils, Association of Swiss Road and Traffic Engineers
2. Minnesota Department of Transportation, Pavement Design, 2007
3. NAVFAC Design Manual 7.2 - Foundations and Earth Structures, SN 0525-LP-300-7071, REVALIDATED BY CHANGE 1 SEPTEMBER 1986

Citation :
Geotechdata.info, Cohesion, <http://geotechdata.info/parameter/cohesion> (as of December 15, 2013).

Other soil parameters

- » Angle of friction
- » Cohesion
- » Dry unit weight
- » Young's modulus
- » Void ratio
- » Soil Permeability coefficient
- » Soil porosity

Can you edit this page? Send us an email to editor@geotechdata.info

Copyright 2008 - Geotechdata.info. All rights reserved. - CONTACT: editor@geotechdata.info

Final Slope Stability Analysis

Circular Failure Surface, Static – Total Slope

Total Slope Yarnell Slope Stability

c:\users\4163apm\desktop\project files\yarnell stability 7.0\pcstabl\total slope\total slope.pl2 Run By: Alex Mandeville 9/28/2018 12:35PM

EL 1500

EL 1400

EL 1300

EL 1200

EL 1100

#	FS	Soil Desc.	Soil Type	Total Unit Wt. (pcf)	Saturated Unit Wt. (pcf)	Cohesion Intercept (psf)	Friction Angle (deg)	Piez. Surface
a	1.82							
b	1.83							
c	1.83	CovrSoil	1	115.0	115.0	200.0	26.0	W1
d	1.84	Waste	2	63.0	63.0	0.0	35.0	W1
e	1.87	FdtnSoil	3	120.0	120.0	200.0	33.0	W1
f	1.88	Bedrock	4	155.0	155.0	200.0	45.0	W1
g	1.90							
h	1.90							
i	1.90							
j	1.91							

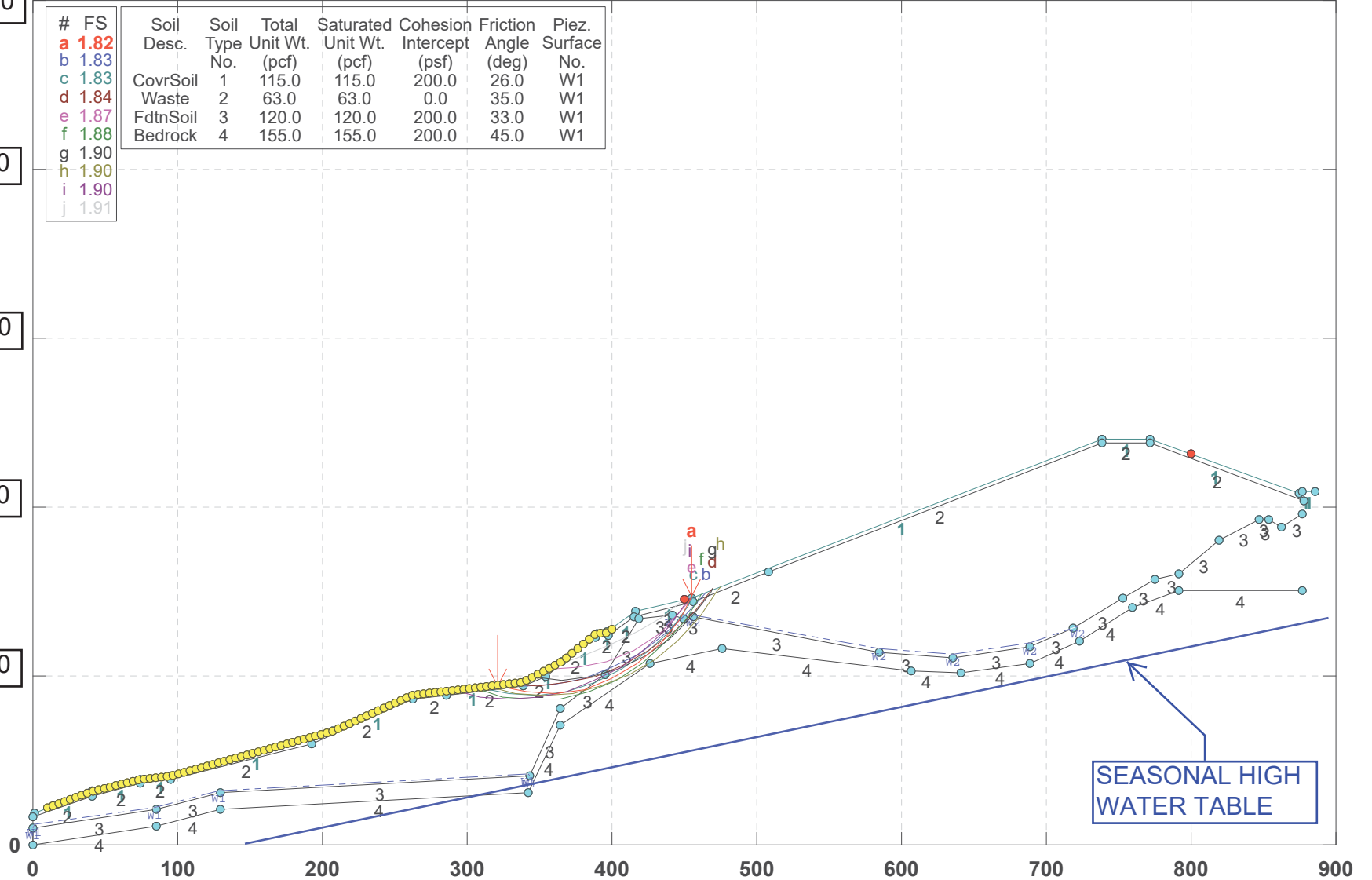

SEASONAL HIGH WATER TABLE

PCSTABL5M3 FSmin=1.82
Safety Factors Are Calculated By The Modified Bishop Method

** PCSTABL5M3 **

by Purdue University 1985
rev. for SCS Engineers HVA 2008

1

--Slope Stability Analysis--
Simplified Janbu, Simplified Bishop
or Spencer`s Method of Slices

Run Date: 9/28/2018
Time of Run: 12:35PM
Run By: Alex Mandeville
Input Data Filename: C:total slope.in

Output Filename: C:total slope.OUT

Unit: ENGLISH
Plotted Output Filename: C:total slope.PLT

PROBLEM DESCRIPTION Total Slope
Yarnell Slope Stability

BOUNDARY COORDINATES

16 Top Boundaries
66 Total Boundaries

Boundary No.	X-Left (ft)	Y-Left (ft)	X-Right (ft)	Y-Right (ft)	Soil Type Below Bnd
1	0.79	19.10	40.68	31.61	1
2	40.68	31.61	73.83	38.70	1
3	73.83	38.70	95.25	40.79	1

4	95.25	40.79	207.06	67.32	1
5	207.06	67.32	262.13	88.70	1
6	262.13	88.70	338.44	96.34	1
7	338.44	96.34	365.69	108.70	1
8	365.69	108.70	389.21	125.27	1
9	389.21	125.27	396.78	125.67	1
10	396.78	125.67	416.18	137.92	1
11	416.18	137.92	454.62	146.48	1
12	454.62	146.48	737.92	240.70	1
13	737.92	240.70	771.51	240.70	1
14	771.51	240.70	874.24	207.87	1
15	874.24	207.87	876.48	208.70	1
16	876.48	208.70	885.67	208.70	1
17	0.00	16.20	40.80	29.11	2
18	40.80	29.11	73.95	36.20	2
19	73.95	36.20	95.37	38.20	2
20	95.37	38.20	193.02	60.20	2
21	193.02	60.20	262.25	86.20	2
22	262.25	86.20	285.38	88.66	2
23	285.38	88.66	338.56	93.83	2
24	338.56	93.83	354.67	99.79	2
25	354.67	99.79	388.95	122.48	2
26	388.95	122.48	397.72	123.68	2
27	397.72	123.68	415.63	135.00	2
28	415.63	135.00	455.96	144.35	2
29	455.96	144.35	508.52	161.85	2
30	508.52	161.85	737.92	238.20	2
31	737.92	238.20	771.51	238.20	2
32	771.51	238.20	878.01	204.16	2
33	0.00	10.22	84.73	20.66	3
34	84.73	20.66	129.10	30.70	3
35	129.10	30.70	343.54	40.70	3
36	343.54	40.70	364.01	80.70	3
37	364.01	80.70	395.37	100.70	3
38	395.37	100.70	418.24	133.47	3
39	418.24	133.47	441.91	136.50	3
40	441.91	136.50	449.72	134.39	3
41	449.72	134.39	455.79	134.93	3
42	455.79	134.93	584.46	114.36	3
43	584.46	114.36	635.63	111.20	3
44	635.63	111.20	689.11	117.76	3
45	689.11	117.76	718.76	128.43	3
46	718.76	128.43	752.55	145.66	3
47	752.55	145.66	775.43	157.70	3
48	775.43	157.70	791.80	160.70	3
49	791.80	160.70	819.76	180.70	3
50	819.76	180.70	847.11	192.70	3
51	847.11	192.70	853.49	192.70	3
52	853.49	192.70	862.52	188.70	3

53	862.52	188.70	877.32	196.31	3
54	0.00	0.00	84.76	10.67	4
55	84.76	10.67	129.10	20.70	4
56	129.10	20.70	342.27	30.55	4
57	342.27	30.55	364.01	70.70	4
58	364.01	70.70	425.71	107.60	4
59	425.71	107.60	476.33	115.70	4
60	476.33	115.70	606.46	102.62	4
61	606.46	102.62	641.41	101.73	4
62	641.41	101.73	688.34	107.88	4
63	688.34	107.88	723.25	120.96	4
64	723.25	120.96	759.00	140.28	4
65	759.00	140.28	791.57	150.96	4
66	791.57	150.96	876.33	150.70	4

1

ISOTROPIC SOIL PARAMETERS

4 Type(s) of Soil

Soil Type No.	Total Unit Wt. (pcf)	Saturated Unit Wt. (pcf)	Cohesion Intercept (psf)	Friction Angle (deg)	Pore Pressure Param.	Pressure Constant (psf)	Piez. Surface No.
1	115.0	115.0	200.0	26.0	0.00	0.0	1
2	63.0	63.0	0.0	35.0	0.00	0.0	1
3	120.0	120.0	200.0	33.0	0.00	0.0	1
4	155.0	155.0	200.0	45.0	0.00	0.0	1

1

2 PIEZOMETRIC SURFACE(S) HAVE BEEN SPECIFIED

Unit Weight of Water = 62.40

Piezometric Surface No. 1 Specified by 6 Coordinate Points

Point No.	X-Water (ft)	Y-Water (ft)
1	0.00	10.22
2	1.37	11.82

3	84.47	22.14
4	128.90	32.20
5	342.54	42.16
6	343.54	40.70

Piezometric Surface No. 2 Specified by 6 Coordinate Points

Point No.	X-Water (ft)	Y-Water (ft)
1	442.13	136.44
2	455.85	136.44
3	584.63	115.85
4	635.58	112.71
5	688.76	119.23
6	721.28	129.64

1

A Critical Failure Surface Searching Method, Using A Random Technique For Generating Circular Surfaces, Has Been Specified.

2000 Trial Surfaces Have Been Generated.

20 Surfaces Initiate From Each Of 100 Points Equally Spaced Along The Ground Surface Between X = 10.00 ft. and X = 400.00 ft.

Each Surface Terminates Between X = 450.00 ft. and X = 800.00 ft.

Unless Further Limitations Were Imposed, The Minimum Elevation At Which A Surface Extends Is Y = 0.00 ft.

20.00 ft. Line Segments Define Each Trial Failure Surface.

1

Following Are Displayed The Ten Most Critical Of The Trial Failure Surfaces Examined. They Are Ordered - Most Critical

First.

* * Safety Factors Are Calculated By The Modified Bishop Method * *

Failure Surface Specified By 9 Coordinate Points

Point No.	X-Surf (ft)	Y-Surf (ft)
1	321.21	94.62
2	340.78	90.46
3	360.76	89.68
4	380.59	92.33
5	399.67	98.30
6	417.46	107.44
7	433.44	119.47
8	447.14	134.04
9	455.56	146.79

Circle Center At X = 355.3 ; Y = 206.7 and Radius, 117.1

*** 1.823 ***

Individual data on the 29 slices

Slice No.	Width (ft)	Weight (lbs)	Water	Water	Tie	Tie	Earthquake		Surcharge Load (lbs)
			Force Top (lbs)	Force Bot (lbs)	Force Norm (lbs)	Force Tan (lbs)	Force Hor (lbs)	Force Ver (lbs)	
1	8.0	1144.3	0.0	0.0	0.0	0.0	0.0	0.0	0.0
2	9.3	3503.5	0.0	0.0	0.0	0.0	0.0	0.0	0.0
3	0.1	56.9	0.0	0.0	0.0	0.0	0.0	0.0	0.0
4	2.2	1172.1	0.0	0.0	0.0	0.0	0.0	0.0	0.0
5	13.9	11477.8	0.0	0.0	0.0	0.0	0.0	0.0	0.0
6	6.1	6900.8	0.0	0.0	0.0	0.0	0.0	0.0	0.0
7	4.9	6002.3	0.0	0.0	0.0	0.0	0.0	0.0	0.0
8	14.9	22717.4	0.0	0.0	0.0	0.0	0.0	0.0	0.0
9	3.2	6021.4	0.0	0.0	0.0	0.0	0.0	0.0	0.0
10	5.1	10298.9	0.0	0.0	0.0	0.0	0.0	0.0	0.0

11	0.3	556.1	0.0	0.0	0.0	0.0	0.0	0.0	0.0	0.0
12	6.2	13189.4	0.0	0.0	0.0	0.0	0.0	0.0	0.0	0.0
13	1.4	3052.1	0.0	0.0	0.0	0.0	0.0	0.0	0.0	0.0
14	0.9	2111.7	0.0	0.0	0.0	0.0	0.0	0.0	0.0	0.0
15	2.0	4644.5	0.0	0.0	0.0	0.0	0.0	0.0	0.0	0.0
16	16.0	46898.7	0.0	0.0	0.0	0.0	0.0	0.0	0.0	0.0
17	0.5	1891.0	0.0	0.0	0.0	0.0	0.0	0.0	0.0	0.0
18	1.3	4467.9	0.0	0.0	0.0	0.0	0.0	0.0	0.0	0.0
19	0.8	2723.2	0.0	0.0	0.0	0.0	0.0	0.0	0.0	0.0
20	15.2	45284.3	0.0	0.0	0.0	0.0	0.0	0.0	0.0	0.0
21	8.5	16925.8	0.0	0.0	0.0	0.0	0.0	0.0	0.0	0.0
22	0.2	337.0	0.0	0.0	0.0	0.0	0.0	0.0	0.0	0.0
23	0.0	3.2	0.0	0.0	0.0	0.0	0.0	0.0	0.0	0.0
24	5.0	5974.4	0.0	0.0	0.0	0.0	0.0	0.0	0.0	0.0
25	0.6	478.7	0.0	0.0	0.0	0.0	0.0	0.0	0.0	0.0
26	1.0	718.8	0.0	0.0	0.0	0.0	0.0	0.0	0.0	0.0
27	4.9	2335.0	0.0	0.0	0.0	0.0	0.0	0.0	0.0	0.0
28	1.0	212.4	0.0	0.0	0.0	0.0	0.0	0.0	0.0	0.0
29	0.9	59.8	0.0	0.0	0.0	0.0	0.0	0.0	0.0	0.0

Failure Surface Specified By 9 Coordinate Points

Point No.	X-Surf (ft)	Y-Surf (ft)
1	321.21	94.62
2	341.19	93.69
3	361.14	95.12
4	380.78	98.90
5	399.83	104.98
6	418.04	113.26
7	435.14	123.63
8	450.90	135.94
9	464.99	149.93

Circle Center At X = 339.0 ; Y = 262.8 and Radius, 169.1

*** 1.831 ***

1

Failure Surface Specified By 10 Coordinate Points

Point	X-Surf	Y-Surf
-------	--------	--------

No.	(ft)	(ft)
1	309.39	93.43
2	329.05	89.72
3	349.03	88.90
4	368.92	90.99
5	388.29	95.95
6	406.74	103.68
7	423.87	114.00
8	439.32	126.70
9	452.76	141.51
10	456.52	147.11

Circle Center At X = 344.7 ; Y = 225.2 and Radius, 136.4

*** 1.833 ***

Failure Surface Specified By 9 Coordinate Points

Point No.	X-Surf (ft)	Y-Surf (ft)
1	329.09	95.40
2	349.06	94.37
3	369.01	95.84
4	388.62	99.80
5	407.57	106.17
6	425.59	114.86
7	442.37	125.74
8	457.66	138.63
9	469.46	151.42

Circle Center At X = 347.3 ; Y = 254.0 and Radius, 159.7

*** 1.839 ***

1

Failure Surface Specified By 7 Coordinate Points

Point No.	X-Surf (ft)	Y-Surf (ft)
1	356.67	104.61
2	376.67	104.74
3	396.34	108.32
4	415.12	115.22
5	432.42	125.25
6	447.74	138.11
7	454.85	146.56

Circle Center At X = 365.9 ; Y = 220.1 and Radius, 115.9

*** 1.866 ***

Failure Surface Specified By 10 Coordinate Points

Point No.	X-Surf (ft)	Y-Surf (ft)
1	305.45	93.04
2	324.79	87.93
3	344.68	85.80
4	364.66	86.69
5	384.28	90.58
6	403.08	97.38
7	420.65	106.94
8	436.58	119.04
9	450.50	133.39
10	461.43	148.75

Circle Center At X = 348.8 ; Y = 217.9 and Radius, 132.2

*** 1.883 ***

1

Failure Surface Specified By 9 Coordinate Points

Point	X-Surf	Y-Surf
-------	--------	--------

No.	(ft)	(ft)
1	344.85	99.25
2	364.80	97.79
3	384.73	99.38
4	404.19	104.00
5	422.72	111.52
6	439.89	121.79
7	455.29	134.54
8	468.57	149.50
9	469.90	151.56

Circle Center At X = 364.4 ; Y = 228.7 and Radius, 130.9

*** 1.897 ***

Failure Surface Specified By 11 Coordinate Points

Point No.	X-Surf (ft)	Y-Surf (ft)
1	313.33	93.83
2	332.93	89.84
3	352.89	88.52
4	372.84	89.89
5	392.43	93.93
6	411.29	100.57
7	429.10	109.69
8	445.51	121.11
9	460.24	134.64
10	473.02	150.02
11	475.05	153.28

Circle Center At X = 352.7 ; Y = 237.0 and Radius, 148.5

*** 1.901 ***

1

Failure Surface Specified By 11 Coordinate Points

Point No.	X-Surf (ft)	Y-Surf (ft)
1	289.70	91.46
2	309.31	87.57
3	329.27	86.18
4	349.23	87.33
5	368.90	90.98
6	387.94	97.09
7	406.06	105.55
8	422.97	116.23
9	438.40	128.96
10	452.09	143.54
11	454.15	146.38

Circle Center At X = 330.2 ; Y = 244.3 and Radius, 158.1

*** 1.903 ***

Failure Surface Specified By 6 Coordinate Points

Point No.	X-Surf (ft)	Y-Surf (ft)
1	360.61	106.39
2	379.95	111.46
3	398.85	118.02
4	417.18	126.02
5	434.82	135.43
6	450.81	145.63

Circle Center At X = 305.6 ; Y = 356.1 and Radius, 255.7

*** 1.905 ***

1

Y A X I S F T

0.00 110.71 221.42 332.13 442.84 553.54

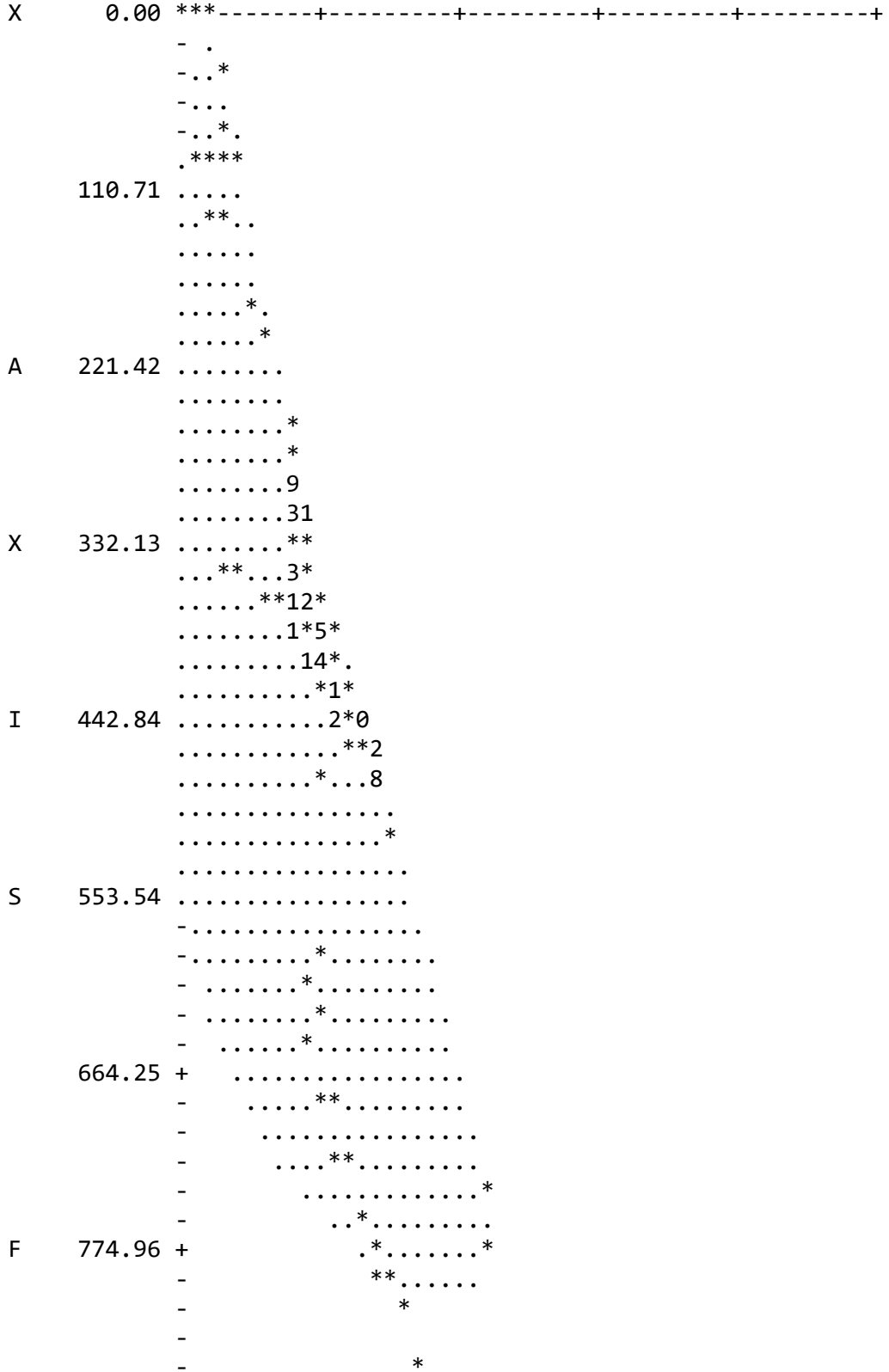

T 885.67 +

* * *
**

Final Slope Stability Analysis

Circular Failure Surface, Seismic – Total Slope = 0.30g

Total Slope - Seismic Yarnell Slope Stability

c:\users\4163apm\desktop\project files\yarnell stability 7.0\pcstabl\seismic - total slope\total slope - seismic.pl2 Run By: Alex Mandeville 9/28/2018 12:28PM

EL 1500

EL 1400

EL 1300

EL 1200

EL 1100

#	FS	Soil Desc.	Soil Type	Total Unit Wt. (pcf)	Saturated Unit Wt. (pcf)	Cohesion Intercept (psf)	Friction Angle (deg)	Piez. Surface	Load Horiz Eqk	Value 0.300 g<
a	1.00									
b	1.01									
c	1.01	CovrSoil	1	115.0	115.0	200.0	26.0	W1		
d	1.02	Waste	2	63.0	63.0	0.0	35.0	W1		
e	1.03	FdtnSoil	3	120.0	200.0	200.0	33.0	W1		
f	1.03	Bedrock	4	155.0	155.0	200.0	45.0	W1		
g	1.03									
h	1.03									
i	1.04									
j	1.04									

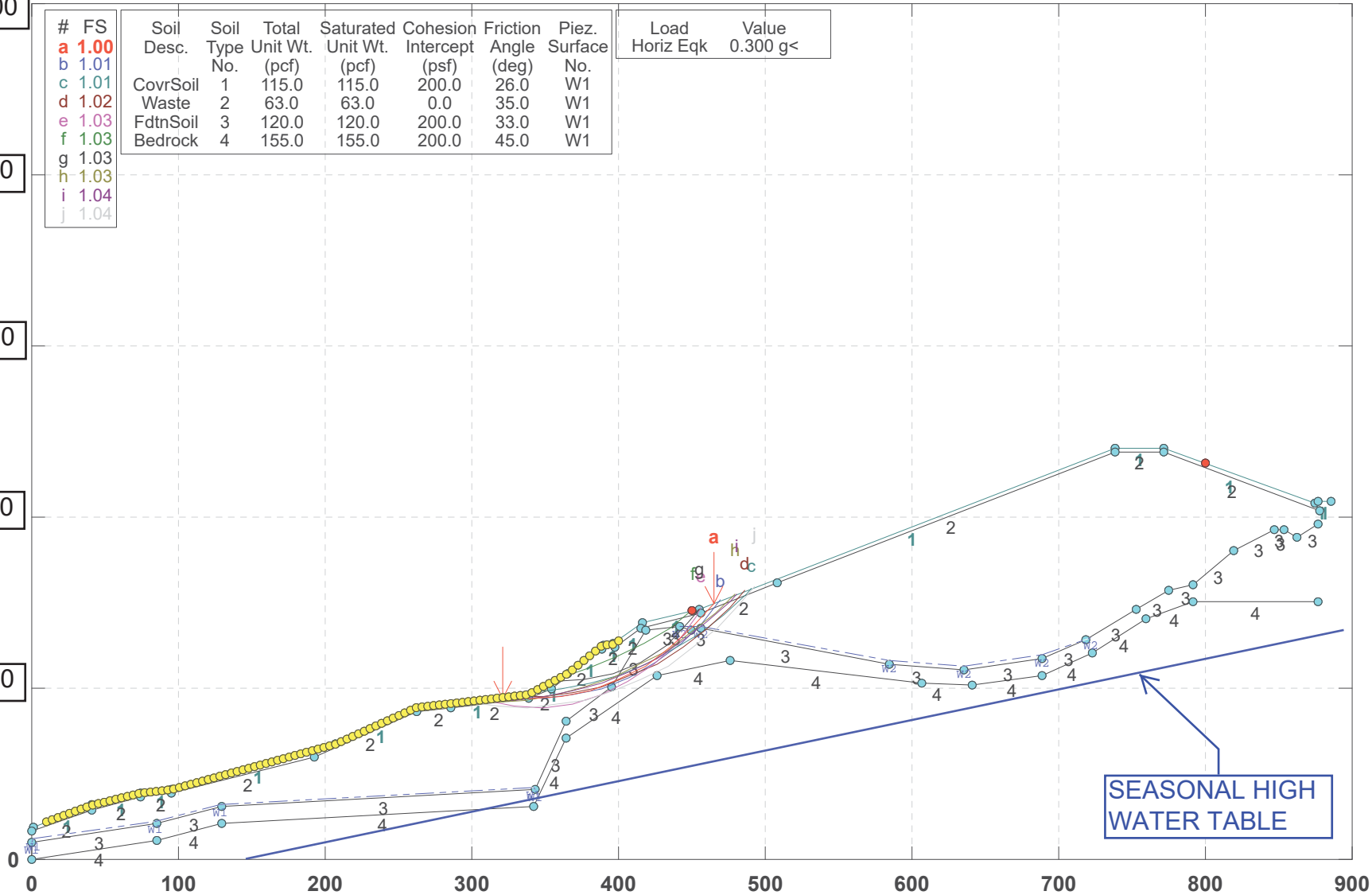

PCSTABL5M3 FSmin=1.00

Safety Factors Are Calculated By The Modified Bishop Method

** PCSTABL5M3 **

by Purdue University 1985
rev. for SCS Engineers HVA 2008

1

--Slope Stability Analysis--
Simplified Janbu, Simplified Bishop
or Spencer`s Method of Slices

Run Date: 9/28/2018
Time of Run: 12:28PM
Run By: Alex Mandeville
Input Data Filename: C:total slope - seismic.in

Output Filename: C:total slope - seismic.OUT

Unit: ENGLISH
Plotted Output Filename: C:total slope - seismic.PLT

PROBLEM DESCRIPTION Total Slope - Seismic
Yarnell Slope Stability

BOUNDARY COORDINATES

16 Top Boundaries
66 Total Boundaries

Boundary No.	X-Left (ft)	Y-Left (ft)	X-Right (ft)	Y-Right (ft)	Soil Type Below Bnd
1	0.79	19.10	40.68	31.61	1
2	40.68	31.61	73.83	38.70	1
3	73.83	38.70	95.25	40.79	1

4	95.25	40.79	207.06	67.32	1
5	207.06	67.32	262.13	88.70	1
6	262.13	88.70	338.44	96.34	1
7	338.44	96.34	365.69	108.70	1
8	365.69	108.70	389.21	125.27	1
9	389.21	125.27	396.78	125.67	1
10	396.78	125.67	416.18	137.92	1
11	416.18	137.92	454.62	146.48	1
12	454.62	146.48	737.92	240.70	1
13	737.92	240.70	771.51	240.70	1
14	771.51	240.70	874.24	207.87	1
15	874.24	207.87	876.48	208.70	1
16	876.48	208.70	885.67	208.70	1
17	0.00	16.20	40.80	29.11	2
18	40.80	29.11	73.95	36.20	2
19	73.95	36.20	95.37	38.20	2
20	95.37	38.20	193.02	60.20	2
21	193.02	60.20	262.25	86.20	2
22	262.25	86.20	285.38	88.66	2
23	285.38	88.66	338.56	93.83	2
24	338.56	93.83	354.67	99.79	2
25	354.67	99.79	388.95	122.48	2
26	388.95	122.48	397.72	123.68	2
27	397.72	123.68	415.63	135.00	2
28	415.63	135.00	455.96	144.35	2
29	455.96	144.35	508.52	161.85	2
30	508.52	161.85	737.92	238.20	2
31	737.92	238.20	771.51	238.20	2
32	771.51	238.20	878.01	204.16	2
33	0.00	10.22	84.73	20.66	3
34	84.73	20.66	129.10	30.70	3
35	129.10	30.70	343.54	40.70	3
36	343.54	40.70	364.01	80.70	3
37	364.01	80.70	395.37	100.70	3
38	395.37	100.70	418.24	133.47	3
39	418.24	133.47	441.91	136.50	3
40	441.91	136.50	449.72	134.39	3
41	449.72	134.39	455.79	134.93	3
42	455.79	134.93	584.46	114.36	3
43	584.46	114.36	635.63	111.20	3
44	635.63	111.20	689.11	117.76	3
45	689.11	117.76	718.76	128.43	3
46	718.76	128.43	752.55	145.66	3
47	752.55	145.66	775.43	157.70	3
48	775.43	157.70	791.80	160.70	3
49	791.80	160.70	819.76	180.70	3
50	819.76	180.70	847.11	192.70	3
51	847.11	192.70	853.49	192.70	3
52	853.49	192.70	862.52	188.70	3

53	862.52	188.70	877.32	196.31	3
54	0.00	0.00	84.76	10.67	4
55	84.76	10.67	129.10	20.70	4
56	129.10	20.70	342.27	30.55	4
57	342.27	30.55	364.01	70.70	4
58	364.01	70.70	425.71	107.60	4
59	425.71	107.60	476.33	115.70	4
60	476.33	115.70	606.46	102.62	4
61	606.46	102.62	641.41	101.73	4
62	641.41	101.73	688.34	107.88	4
63	688.34	107.88	723.25	120.96	4
64	723.25	120.96	759.00	140.28	4
65	759.00	140.28	791.57	150.96	4
66	791.57	150.96	876.33	150.70	4

1

ISOTROPIC SOIL PARAMETERS

4 Type(s) of Soil

Soil Type No.	Total Unit Wt. (pcf)	Saturated Unit Wt. (pcf)	Cohesion Intercept (psf)	Friction Angle (deg)	Pore Pressure Param.	Pressure Constant (psf)	Piez. Surface No.
1	115.0	115.0	200.0	26.0	0.00	0.0	1
2	63.0	63.0	0.0	35.0	0.00	0.0	1
3	120.0	120.0	200.0	33.0	0.00	0.0	1
4	155.0	155.0	200.0	45.0	0.00	0.0	1

1

2 PIEZOMETRIC SURFACE(S) HAVE BEEN SPECIFIED

Unit Weight of Water = 62.40

Piezometric Surface No. 1 Specified by 6 Coordinate Points

Point No.	X-Water (ft)	Y-Water (ft)
1	0.00	10.22
2	1.37	11.82

3	84.47	22.14
4	128.90	32.20
5	342.54	42.16
6	343.54	40.70

Piezometric Surface No. 2 Specified by 6 Coordinate Points

Point No.	X-Water (ft)	Y-Water (ft)
1	442.13	136.44
2	455.85	136.44
3	584.63	115.85
4	635.58	112.71
5	688.76	119.23
6	721.28	129.64

A Horizontal Earthquake Loading Coefficient Of 0.300 Has Been Assigned

A Vertical Earthquake Loading Coefficient Of 0.000 Has Been Assigned

Cavitation Pressure = 0.0 (psf)

1

A Critical Failure Surface Searching Method, Using A Random Technique For Generating Circular Surfaces, Has Been Specified.

2000 Trial Surfaces Have Been Generated.

20 Surfaces Initiate From Each Of 100 Points Equally Spaced Along The Ground Surface Between X = 10.00 ft. and X = 400.00 ft.

Each Surface Terminates Between X = 450.00 ft. and X = 800.00 ft.

Unless Further Limitations Were Imposed, The Minimum Elevation

At Which A Surface Extends Is $Y = 0.00$ ft.

20.00 ft. Line Segments Define Each Trial Failure Surface.

1

Following Are Displayed The Ten Most Critical Of The Trial Failure Surfaces Examined. They Are Ordered - Most Critical First.

* * Safety Factors Are Calculated By The Modified Bishop Method * *

Failure Surface Specified By 9 Coordinate Points

Point No.	X-Surf (ft)	Y-Surf (ft)
1	321.21	94.62
2	341.19	93.69
3	361.14	95.12
4	380.78	98.90
5	399.83	104.98
6	418.04	113.26
7	435.14	123.63
8	450.90	135.94
9	464.99	149.93

Circle Center At $X = 339.0$; $Y = 262.8$ and Radius, 169.1

*** 1.004 ***

Individual data on the 29 slices

Slice No.	Width (ft)	Weight (lbs)	Water Force Top (lbs)	Water Force Bot (lbs)	Tie Force Norm (lbs)	Tie Force Tan (lbs)	Earthquake Force Hor (lbs)	Earthquake Force Ver (lbs)	Surcharge Load (lbs)
-----------	------------	--------------	-----------------------	-----------------------	----------------------	---------------------	----------------------------	----------------------------	----------------------

1	17.2	2494.0	0.0	0.0	0.0	0.0	748.2	0.0	0.0
2	0.0	7.8	0.0	0.0	0.0	0.0	2.3	0.0	0.0
3	0.1	35.2	0.0	0.0	0.0	0.0	10.6	0.0	0.0
4	2.6	903.5	0.0	0.0	0.0	0.0	271.0	0.0	0.0
5	13.5	7843.3	0.0	0.0	0.0	0.0	2353.0	0.0	0.0
6	6.5	5278.5	0.0	0.0	0.0	0.0	1583.5	0.0	0.0
7	4.6	3965.6	0.0	0.0	0.0	0.0	1189.7	0.0	0.0
8	15.1	17265.5	0.0	0.0	0.0	0.0	5179.6	0.0	0.0
9	8.2	12360.7	0.0	0.0	0.0	0.0	3708.2	0.0	0.0
10	0.3	423.4	0.0	0.0	0.0	0.0	127.0	0.0	0.0
11	7.6	11772.4	0.0	0.0	0.0	0.0	3531.7	0.0	0.0
12	0.9	1406.8	0.0	0.0	0.0	0.0	422.0	0.0	0.0
13	0.2	320.3	0.0	0.0	0.0	0.0	96.1	0.0	0.0
14	1.9	3048.5	0.0	0.0	0.0	0.0	914.6	0.0	0.0
15	15.8	34883.0	0.0	0.0	0.0	0.0	10464.9	0.0	0.0
16	0.5	1518.2	0.0	0.0	0.0	0.0	455.5	0.0	0.0
17	1.9	5250.9	0.0	0.0	0.0	0.0	1575.3	0.0	0.0
18	0.2	571.4	0.0	0.0	0.0	0.0	171.4	0.0	0.0
19	16.9	41003.1	0.0	0.0	0.0	0.0	12300.9	0.0	0.0
20	6.8	11779.2	0.0	0.0	0.0	0.0	3533.8	0.0	0.0
21	0.2	326.3	0.0	0.0	0.0	0.0	97.9	0.0	0.0
22	0.0	3.1	0.0	0.0	0.0	0.0	0.9	0.0	0.0
23	7.0	7953.6	0.0	0.0	0.0	0.0	2386.1	0.0	0.0
24	1.8	1373.2	0.0	0.0	0.0	0.0	412.0	0.0	0.0
25	0.5	365.2	0.0	0.0	0.0	0.0	109.6	0.0	0.0
26	3.2	2050.3	0.0	0.0	0.0	0.0	615.1	0.0	0.0
27	1.3	715.2	0.0	0.0	0.0	0.0	214.6	0.0	0.0
28	5.1	2065.7	0.0	0.0	0.0	0.0	619.7	0.0	0.0
29	3.9	577.0	0.0	0.0	0.0	0.0	173.1	0.0	0.0

Failure Surface Specified By 9 Coordinate Points

Point No.	X-Surf (ft)	Y-Surf (ft)
1	329.09	95.40
2	349.06	94.37
3	369.01	95.84
4	388.62	99.80
5	407.57	106.17
6	425.59	114.86
7	442.37	125.74
8	457.66	138.63
9	469.46	151.42

Circle Center At X = 347.3 ; Y = 254.0 and Radius, 159.7

*** 1.007 ***

1

Failure Surface Specified By 10 Coordinate Points

Point No.	X-Surf (ft)	Y-Surf (ft)
1	340.91	97.46
2	360.82	99.37
3	380.51	102.87
4	399.86	107.94
5	418.74	114.54
6	437.03	122.63
7	454.61	132.15
8	471.38	143.06
9	487.22	155.27
10	490.79	158.51

Circle Center At X = 327.3 ; Y = 345.4 and Radius, 248.3

*** 1.014 ***

Failure Surface Specified By 10 Coordinate Points

Point No.	X-Surf (ft)	Y-Surf (ft)
1	329.09	95.40
2	349.09	95.40
3	369.00	97.32
4	388.63	101.16
5	407.79	106.88
6	426.32	114.42
7	444.02	123.72
8	460.75	134.68
9	476.34	147.21
10	486.42	157.06

Circle Center At X = 339.3 ; Y = 300.9 and Radius, 205.7

*** 1.018 ***

1

Failure Surface Specified By 10 Coordinate Points

Point No.	X-Surf (ft)	Y-Surf (ft)
1	309.39	93.43
2	329.05	89.72
3	349.03	88.90
4	368.92	90.99
5	388.29	95.95
6	406.74	103.68
7	423.87	114.00
8	439.32	126.70
9	452.76	141.51
10	456.52	147.11

Circle Center At X = 344.7 ; Y = 225.2 and Radius, 136.4

*** 1.025 ***

Failure Surface Specified By 6 Coordinate Points

Point No.	X-Surf (ft)	Y-Surf (ft)
1	360.61	106.39
2	379.95	111.46
3	398.85	118.02
4	417.18	126.02
5	434.82	135.43
6	450.81	145.63

Circle Center At X = 305.6 ; Y = 356.1 and Radius, 255.7

*** 1.027 ***

1

Failure Surface Specified By 7 Coordinate Points

Point No.	X-Surf (ft)	Y-Surf (ft)
1	356.67	104.61
2	376.67	104.74
3	396.34	108.32
4	415.12	115.22
5	432.42	125.25
6	447.74	138.11
7	454.85	146.56

Circle Center At X = 365.9 ; Y = 220.1 and Radius, 115.9

*** 1.030 ***

Failure Surface Specified By 11 Coordinate Points

Point No.	X-Surf (ft)	Y-Surf (ft)
1	297.58	92.25
2	317.57	91.93
3	337.53	93.18
4	357.34	95.98
5	376.86	100.32
6	395.99	106.17
7	414.60	113.49
8	432.58	122.24
9	449.83	132.37
10	466.23	143.82
11	479.58	154.78

Circle Center At X = 311.6 ; Y = 347.9 and Radius, 256.1

*** 1.034 ***

1

Failure Surface Specified By 11 Coordinate Points

Point No.	X-Surf (ft)	Y-Surf (ft)
1	309.39	93.43
2	329.39	93.32
3	349.33	94.89
4	369.07	98.13
5	388.47	103.00
6	407.39	109.49
7	425.69	117.54
8	443.27	127.09
9	459.97	138.08
10	475.70	150.44
11	480.80	155.19

Circle Center At X = 320.7 ; Y = 331.6 and Radius, 238.4

*** 1.035 ***

Failure Surface Specified By 12 Coordinate Points

Point No.	X-Surf (ft)	Y-Surf (ft)
1	297.58	92.25
2	317.42	89.73
3	337.41	89.08
4	357.37	90.30
5	377.13	93.38
6	396.52	98.30
7	415.36	105.01
8	433.49	113.46
9	450.75	123.56
10	466.99	135.23
11	482.06	148.37

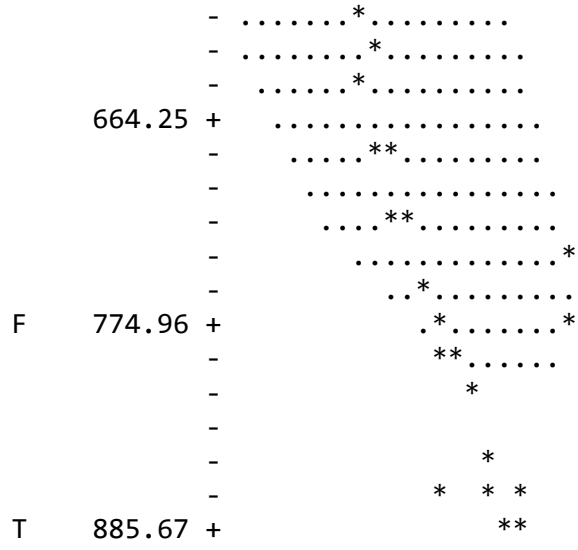

Final Slope Stability Analysis

Circular Failure Surface, Static – Top Slope – Large

Top of Slope - Large Yarnell Slope Stability

c:\users\4163apm\desktop\project files\yarnell stability 7.0\pcstabl\top of slope - large\top of slope - large.pl2 Run By: Alex Mandeville 9/28/2018 12:34PM

EL 1500

EL 1400

EL 1300

EL 1200

EL 1100

#	FS	Soil Desc.	Soil Type	Total Unit Wt. (pcf)	Saturated Unit Wt. (pcf)	Cohesion Intercept (psf)	Friction Angle (deg)	Piez. Surface No.
a	2.21							
b	2.21							
c	2.21	CovrSoil	1	115.0	115.0	200.0	26.0	W1
d	2.21	Waste	2	63.0	63.0	0.0	35.0	W1
e	2.21	FdtnSoil	3	120.0	120.0	200.0	33.0	W1
f	2.22	Bedrock	4	155.0	155.0	200.0	45.0	W1
g	2.22							
h	2.23							
i	2.23							
j	2.23							

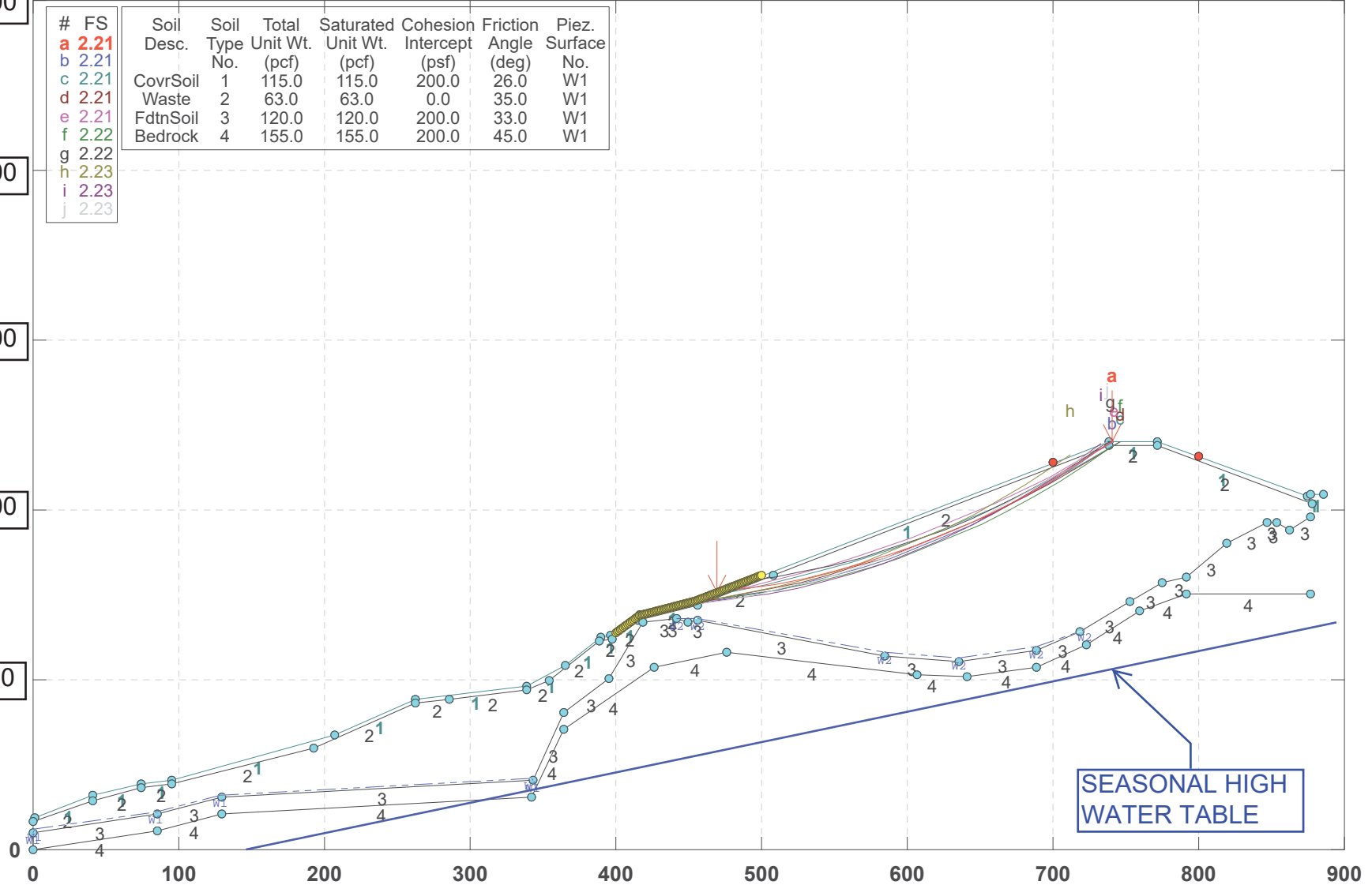

PCSTABL5M3 FSmin=2.21

Safety Factors Are Calculated By The Modified Bishop Method

** PCSTABL5M3 **

by Purdue University 1985
rev. for SCS Engineers HVA 2008

1

--Slope Stability Analysis--
Simplified Janbu, Simplified Bishop
or Spencer`s Method of Slices

Run Date: 9/28/2018
Time of Run: 12:34PM
Run By: Alex Mandeville
Input Data Filename: C:top of slope - large.in

Output Filename: C:top of slope - large.OUT

Unit: ENGLISH
Plotted Output Filename: C:top of slope - large.PLT

PROBLEM DESCRIPTION Top of Slope - Large
Yarnell Slope Stability

BOUNDARY COORDINATES

16 Top Boundaries
66 Total Boundaries

Boundary No.	X-Left (ft)	Y-Left (ft)	X-Right (ft)	Y-Right (ft)	Soil Type Below Bnd
1	0.79	19.10	40.68	31.61	1
2	40.68	31.61	73.83	38.70	1
3	73.83	38.70	95.25	40.79	1

4	95.25	40.79	207.06	67.32	1
5	207.06	67.32	262.13	88.70	1
6	262.13	88.70	338.44	96.34	1
7	338.44	96.34	365.69	108.70	1
8	365.69	108.70	389.21	125.27	1
9	389.21	125.27	396.78	125.67	1
10	396.78	125.67	416.18	137.92	1
11	416.18	137.92	454.62	146.48	1
12	454.62	146.48	737.92	240.70	1
13	737.92	240.70	771.51	240.70	1
14	771.51	240.70	874.24	207.87	1
15	874.24	207.87	876.48	208.70	1
16	876.48	208.70	885.67	208.70	1
17	0.00	16.20	40.80	29.11	2
18	40.80	29.11	73.95	36.20	2
19	73.95	36.20	95.37	38.20	2
20	95.37	38.20	193.02	60.20	2
21	193.02	60.20	262.25	86.20	2
22	262.25	86.20	285.38	88.66	2
23	285.38	88.66	338.56	93.83	2
24	338.56	93.83	354.67	99.79	2
25	354.67	99.79	388.95	122.48	2
26	388.95	122.48	397.72	123.68	2
27	397.72	123.68	415.63	135.00	2
28	415.63	135.00	455.96	144.35	2
29	455.96	144.35	508.52	161.85	2
30	508.52	161.85	737.92	238.20	2
31	737.92	238.20	771.51	238.20	2
32	771.51	238.20	878.01	204.16	2
33	0.00	10.22	84.73	20.66	3
34	84.73	20.66	129.10	30.70	3
35	129.10	30.70	343.54	40.70	3
36	343.54	40.70	364.01	80.70	3
37	364.01	80.70	395.37	100.70	3
38	395.37	100.70	418.24	133.47	3
39	418.24	133.47	441.91	136.50	3
40	441.91	136.50	449.72	134.39	3
41	449.72	134.39	455.79	134.93	3
42	455.79	134.93	584.46	114.36	3
43	584.46	114.36	635.63	111.20	3
44	635.63	111.20	689.11	117.76	3
45	689.11	117.76	718.76	128.43	3
46	718.76	128.43	752.55	145.66	3
47	752.55	145.66	775.43	157.70	3
48	775.43	157.70	791.80	160.70	3
49	791.80	160.70	819.76	180.70	3
50	819.76	180.70	847.11	192.70	3
51	847.11	192.70	853.49	192.70	3
52	853.49	192.70	862.52	188.70	3

53	862.52	188.70	877.32	196.31	3
54	0.00	0.00	84.76	10.67	4
55	84.76	10.67	129.10	20.70	4
56	129.10	20.70	342.27	30.55	4
57	342.27	30.55	364.01	70.70	4
58	364.01	70.70	425.71	107.60	4
59	425.71	107.60	476.33	115.70	4
60	476.33	115.70	606.46	102.62	4
61	606.46	102.62	641.41	101.73	4
62	641.41	101.73	688.34	107.88	4
63	688.34	107.88	723.25	120.96	4
64	723.25	120.96	759.00	140.28	4
65	759.00	140.28	791.57	150.96	4
66	791.57	150.96	876.33	150.70	4

1

ISOTROPIC SOIL PARAMETERS

4 Type(s) of Soil

Soil Type No.	Total Unit Wt. (pcf)	Saturated Unit Wt. (pcf)	Cohesion Intercept (psf)	Friction Angle (deg)	Pore Pressure Param.	Pressure Constant (psf)	Piez. Surface No.
1	115.0	115.0	200.0	26.0	0.00	0.0	1
2	63.0	63.0	0.0	35.0	0.00	0.0	1
3	120.0	120.0	200.0	33.0	0.00	0.0	1
4	155.0	155.0	200.0	45.0	0.00	0.0	1

1

2 PIEZOMETRIC SURFACE(S) HAVE BEEN SPECIFIED

Unit Weight of Water = 62.40

Piezometric Surface No. 1 Specified by 6 Coordinate Points

Point No.	X-Water (ft)	Y-Water (ft)
1	0.00	10.22
2	1.37	11.82

3	84.47	22.14
4	128.90	32.20
5	342.54	42.16
6	343.54	40.70

Piezometric Surface No. 2 Specified by 6 Coordinate Points

Point No.	X-Water (ft)	Y-Water (ft)
1	442.13	136.44
2	455.85	136.44
3	584.63	115.85
4	635.58	112.71
5	688.76	119.23
6	721.28	129.64

1

A Critical Failure Surface Searching Method, Using A Random Technique For Generating Circular Surfaces, Has Been Specified.

2000 Trial Surfaces Have Been Generated.

20 Surfaces Initiate From Each Of 100 Points Equally Spaced Along The Ground Surface Between X = 400.00 ft. and X = 500.00 ft.

Each Surface Terminates Between X = 700.00 ft. and X = 800.00 ft.

Unless Further Limitations Were Imposed, The Minimum Elevation At Which A Surface Extends Is Y = 0.00 ft.

20.00 ft. Line Segments Define Each Trial Failure Surface.

1

Following Are Displayed The Ten Most Critical Of The Trial Failure Surfaces Examined. They Are Ordered - Most Critical

First.

* * Safety Factors Are Calculated By The Modified Bishop Method * *

Failure Surface Specified By 16 Coordinate Points

Point No.	X-Surf (ft)	Y-Surf (ft)
1	469.70	151.49
2	489.58	153.62
3	509.39	156.37
4	529.11	159.74
5	548.71	163.73
6	568.17	168.34
7	587.48	173.55
8	606.61	179.36
9	625.56	185.78
10	644.29	192.78
11	662.79	200.38
12	681.05	208.55
13	699.04	217.28
14	716.74	226.58
15	734.15	236.43
16	741.16	240.70

Circle Center At X = 412.3 ; Y = 784.0 and Radius, 635.1

*** 2.205 ***

Individual data on the 19 slices

Slice No.	Width (ft)	Weight (lbs)	Water Force Top (lbs)	Water Force Bot (lbs)	Tie Force Norm (lbs)	Tie Force Tan (lbs)	Earthquake Force Hor (lbs)	Earthquake Force Ver (lbs)	Surcharge Load (lbs)
1	11.4	1678.3	0.0	0.0	0.0	0.0	0.0	0.0	0.0
2	8.5	3026.7	0.0	0.0	0.0	0.0	0.0	0.0	0.0
3	18.9	10061.5	0.0	0.0	0.0	0.0	0.0	0.0	0.0

4	0.9	569.9	0.0	0.0	0.0	0.0	0.0	0.0	0.0	0.0
5	19.7	14934.6	0.0	0.0	0.0	0.0	0.0	0.0	0.0	0.0
6	19.6	18369.4	0.0	0.0	0.0	0.0	0.0	0.0	0.0	0.0
7	19.5	20934.8	0.0	0.0	0.0	0.0	0.0	0.0	0.0	0.0
8	19.3	22637.4	0.0	0.0	0.0	0.0	0.0	0.0	0.0	0.0
9	19.1	23488.9	0.0	0.0	0.0	0.0	0.0	0.0	0.0	0.0
10	18.9	23507.1	0.0	0.0	0.0	0.0	0.0	0.0	0.0	0.0
11	18.7	22715.4	0.0	0.0	0.0	0.0	0.0	0.0	0.0	0.0
12	18.5	21142.3	0.0	0.0	0.0	0.0	0.0	0.0	0.0	0.0
13	18.3	18822.0	0.0	0.0	0.0	0.0	0.0	0.0	0.0	0.0
14	18.0	15793.7	0.0	0.0	0.0	0.0	0.0	0.0	0.0	0.0
15	17.7	12101.7	0.0	0.0	0.0	0.0	0.0	0.0	0.0	0.0
16	17.4	7794.8	0.0	0.0	0.0	0.0	0.0	0.0	0.0	0.0
17	1.9	562.6	0.0	0.0	0.0	0.0	0.0	0.0	0.0	0.0
18	1.9	493.0	0.0	0.0	0.0	0.0	0.0	0.0	0.0	0.0
19	3.2	367.7	0.0	0.0	0.0	0.0	0.0	0.0	0.0	0.0

Failure Surface Specified By 17 Coordinate Points

Point No.	X-Surf (ft)	Y-Surf (ft)
1	451.52	145.79
2	471.43	147.65
3	491.27	150.13
4	511.03	153.23
5	530.68	156.95
6	550.21	161.28
7	569.59	166.22
8	588.81	171.76
9	607.84	177.89
10	626.68	184.62
11	645.29	191.94
12	663.67	199.83
13	681.79	208.29
14	699.64	217.32
15	717.19	226.90
16	734.44	237.02
17	740.29	240.70

Circle Center At X = 401.9 ; Y = 783.9 and Radius, 640.0

*** 2.208 ***

Failure Surface Specified By 16 Coordinate Points

Point No.	X-Surf (ft)	Y-Surf (ft)
1	464.65	149.81
2	484.42	152.83
3	504.11	156.30
4	523.72	160.23
5	543.24	164.61
6	562.65	169.45
7	581.94	174.73
8	601.10	180.46
9	620.12	186.63
10	639.00	193.25
11	657.71	200.29
12	676.26	207.77
13	694.63	215.68
14	712.81	224.02
15	730.80	232.77
16	746.17	240.70

Circle Center At X = 344.8 ; Y = 1002.5 and Radius, 861.1

*** 2.209 ***

Failure Surface Specified By 17 Coordinate Points

Point No.	X-Surf (ft)	Y-Surf (ft)
1	447.48	144.89
2	467.34	147.22
3	487.13	150.08
4	506.85	153.45
5	526.47	157.33
6	545.98	161.73
7	565.37	166.64
8	584.62	172.05
9	603.73	177.96
10	622.67	184.37
11	641.44	191.28

12	660.02	198.67
13	678.41	206.55
14	696.58	214.90
15	714.53	223.73
16	732.23	233.03
17	745.97	240.70

Circle Center At X = 368.2 ; Y = 905.2 and Radius, 764.4

*** 2.213 ***

1

Failure Surface Specified By 16 Coordinate Points

Point No.	X-Surf (ft)	Y-Surf (ft)
1	467.68	150.82
2	487.36	154.36
3	506.97	158.30
4	526.49	162.64
5	545.92	167.38
6	565.25	172.53
7	584.47	178.06
8	603.57	183.99
9	622.54	190.32
10	641.38	197.03
11	660.08	204.13
12	678.63	211.61
13	697.02	219.47
14	715.25	227.70
15	733.30	236.31
16	742.03	240.70

Circle Center At X = 306.1 ; Y = 1107.8 and Radius, 970.5

*** 2.214 ***

Failure Surface Specified By 17 Coordinate Points

Point No.	X-Surf (ft)	Y-Surf (ft)
1	456.57	147.13
2	476.50	148.75
3	496.37	151.01
4	516.16	153.91
5	535.85	157.44
6	555.41	161.61
7	574.82	166.40
8	594.08	171.82
9	613.15	177.85
10	632.01	184.49
11	650.65	191.74
12	669.05	199.58
13	687.19	208.01
14	705.04	217.01
15	722.60	226.59
16	739.84	236.73
17	746.12	240.70

Circle Center At X = 416.2 ; Y = 767.4 and Radius, 621.6

*** 2.215 ***

1

Failure Surface Specified By 15 Coordinate Points

Point No.	X-Surf (ft)	Y-Surf (ft)
1	488.89	157.88
2	508.73	160.39
3	528.49	163.51
4	548.13	167.26
5	567.65	171.62
6	587.02	176.59
7	606.23	182.17
8	625.25	188.34
9	644.07	195.11
10	662.67	202.47
11	681.03	210.40
12	699.13	218.91

13	716.95	227.98
14	734.49	237.61
15	739.72	240.70

Circle Center At X = 418.8 ; Y = 791.7 and Radius, 637.7

*** 2.217 ***

Failure Surface Specified By 15 Coordinate Points

Point No.	X-Surf (ft)	Y-Surf (ft)
1	452.53	146.01
2	472.39	148.37
3	492.16	151.35
4	511.84	154.95
5	531.39	159.17
6	550.79	164.01
7	570.03	169.46
8	589.09	175.52
9	607.95	182.18
10	626.59	189.43
11	644.99	197.26
12	663.14	205.68
13	681.01	214.66
14	698.58	224.21
15	712.12	232.12

Circle Center At X = 388.1 ; Y = 775.0 and Radius, 632.3

*** 2.225 ***

1

Failure Surface Specified By 17 Coordinate Points

Point No.	X-Surf (ft)	Y-Surf (ft)
-----------	-------------	-------------

1	445.46	144.44
2	465.41	145.83
3	485.30	147.91
4	505.10	150.69
5	524.80	154.14
6	544.37	158.28
7	563.78	163.09
8	583.02	168.58
9	602.05	174.73
10	620.86	181.53
11	639.42	188.98
12	657.71	197.07
13	675.70	205.79
14	693.39	215.13
15	710.74	225.08
16	727.74	235.62
17	732.77	238.99

Circle Center At X = 415.3 ; Y = 720.4 and Radius, 576.7

*** 2.226 ***

Failure Surface Specified By 17 Coordinate Points

Point No.	X-Surf (ft)	Y-Surf (ft)
1	439.39	143.09
2	459.30	145.07
3	479.13	147.64
4	498.88	150.78
5	518.53	154.51
6	538.07	158.80
7	557.46	163.67
8	576.71	169.10
9	595.79	175.09
10	614.69	181.64
11	633.39	188.74
12	651.87	196.39
13	670.12	204.57
14	688.12	213.29
15	705.86	222.52
16	723.32	232.27
17	736.79	240.32

Circle Center At X = 381.6 ; Y = 823.5 and Radius, 682.9

*** 2.229 ***

1

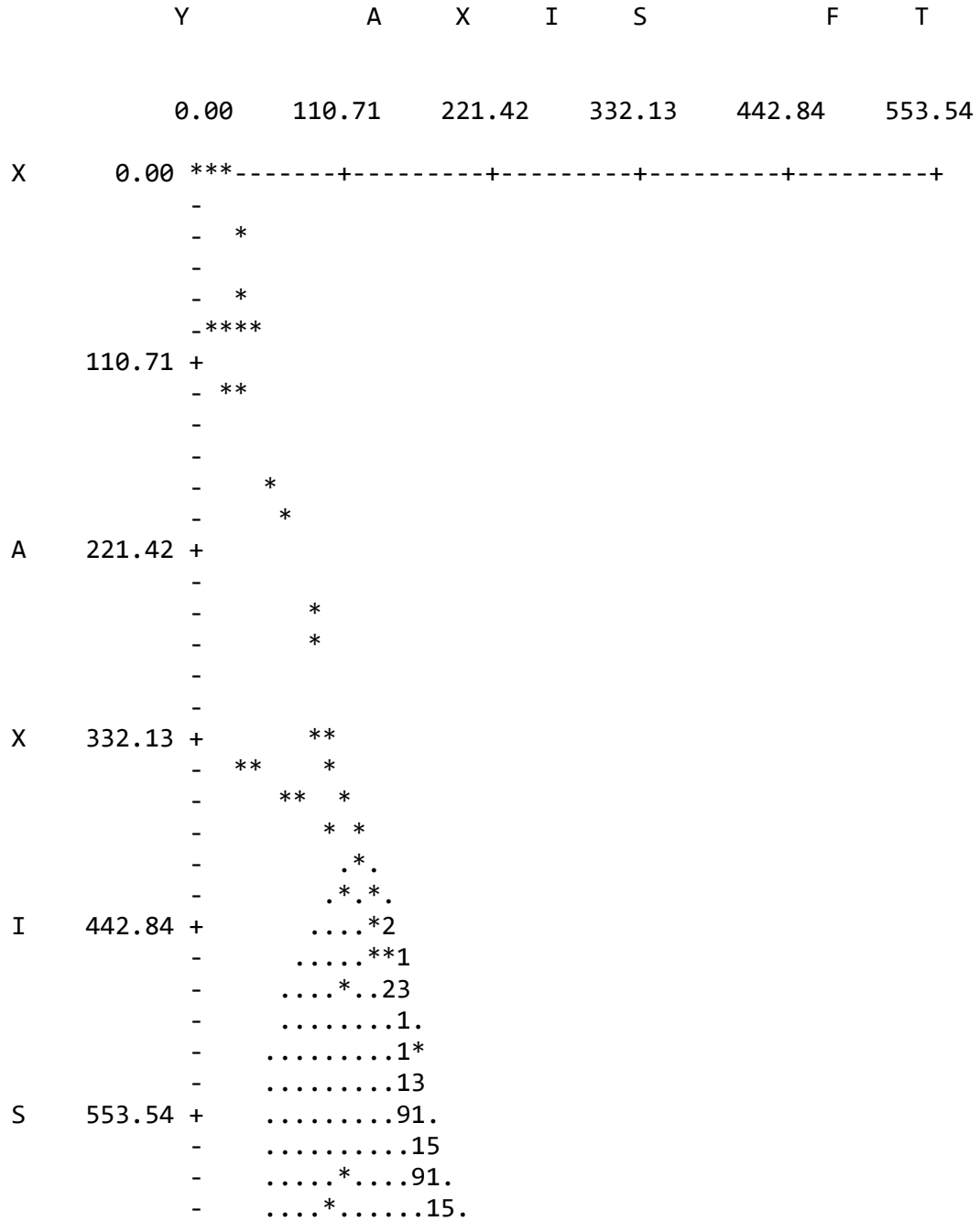

	-*91.
	-*15.
664.25	+18
	-	...**1.
	-31.
	-	..**15
	-1*
	-	.*
F	774.96	+	*.....*
	-	**
	-	*	
	-		*
	-	*	* *
T	885.67	+	**

Final Slope Stability Analysis

Circular Failure Surface, Seismic – Top Slope – Large =
0.30g

Top of Slope - Large - Seismic Yarnell Slope Stability

c:\users\4163apm\desktop\project files\yarnell stability 7.0\pcstabl\seismic - top of slope - large\top of slope - large - seismic.pl2 Run By: Alex Mandeville 9/28/2018 12:33PM

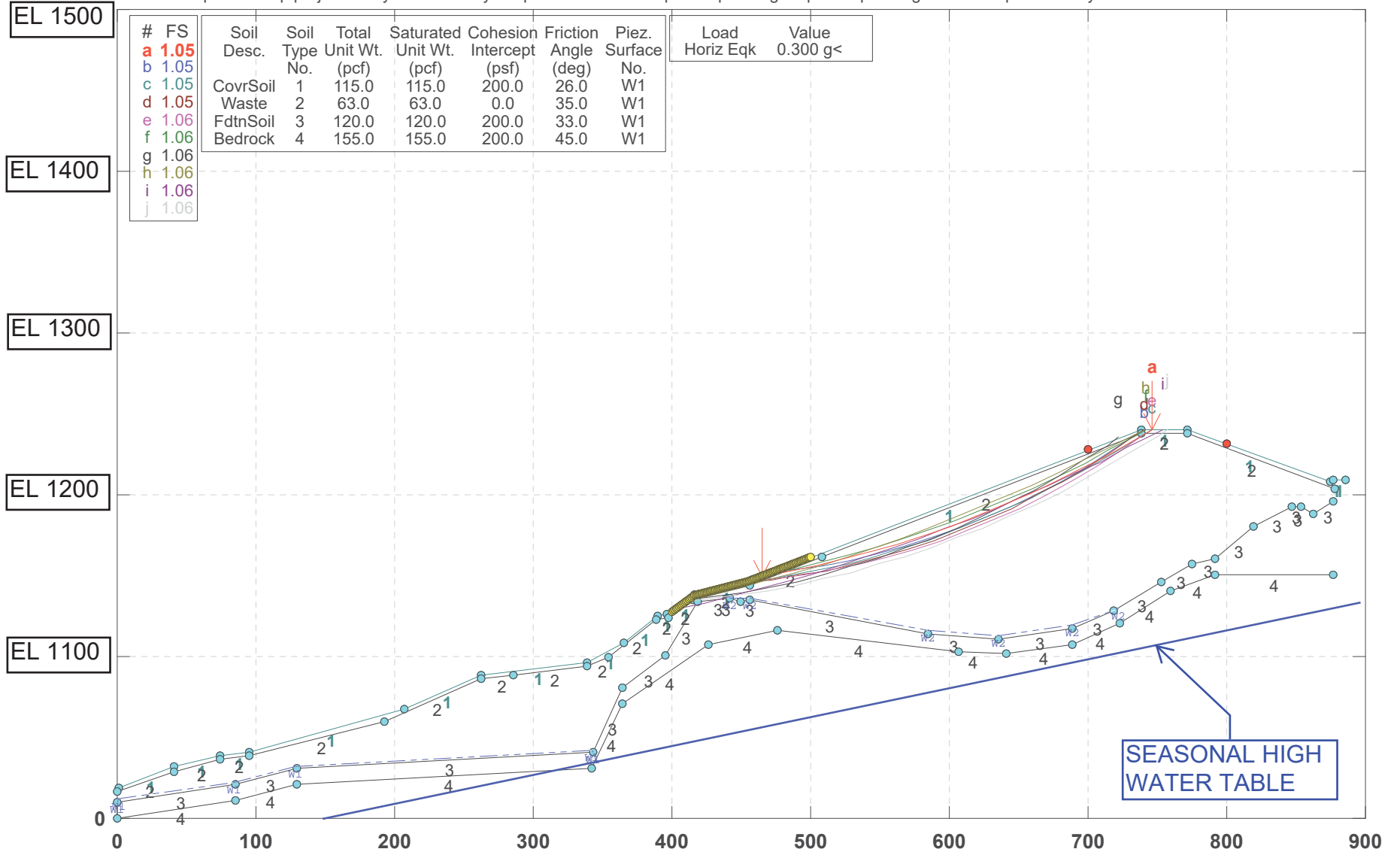

#	FS	Soil Desc.	Soil Type	Total Unit Wt. (pcf)	Saturated Unit Wt. (pcf)	Cohesion Intercept (psf)	Friction Angle (deg)	Piez. Surface No.	Load Horiz Eqk	Value 0.300 g<
a	1.05									
b	1.05									
c	1.05	CovrSoil	1	115.0	115.0	200.0	26.0	W1		
d	1.05	Waste	2	63.0	63.0	0.0	35.0	W1		
e	1.06	FdtnSoil	3	120.0	120.0	200.0	33.0	W1		
f	1.06	Bedrock	4	155.0	155.0	200.0	45.0	W1		
g	1.06									
h	1.06									
i	1.06									
j	1.06									

PCSTABL5M3 FSmin=1.05
 Safety Factors Are Calculated By The Modified Bishop Method

** PCSTABL5M3 **

by Purdue University 1985
rev. for SCS Engineers HVA 2008

1

--Slope Stability Analysis--
Simplified Janbu, Simplified Bishop
or Spencer`s Method of Slices

Run Date: 9/28/2018
Time of Run: 12:33PM
Run By: Alex Mandeville
Input Data Filename: C:top of slope - large - seismic.in

Output Filename: C:top of slope - large - seismic.OUT

Unit: ENGLISH
Plotted Output Filename: C:top of slope - large - seismic.PLT

PROBLEM DESCRIPTION Top of Slope - Large - Seismic
Yarnell Slope Stability

BOUNDARY COORDINATES

16 Top Boundaries
66 Total Boundaries

Boundary No.	X-Left (ft)	Y-Left (ft)	X-Right (ft)	Y-Right (ft)	Soil Type Below Bnd
1	0.79	19.10	40.68	31.61	1
2	40.68	31.61	73.83	38.70	1
3	73.83	38.70	95.25	40.79	1

4	95.25	40.79	207.06	67.32	1
5	207.06	67.32	262.13	88.70	1
6	262.13	88.70	338.44	96.34	1
7	338.44	96.34	365.69	108.70	1
8	365.69	108.70	389.21	125.27	1
9	389.21	125.27	396.78	125.67	1
10	396.78	125.67	416.18	137.92	1
11	416.18	137.92	454.62	146.48	1
12	454.62	146.48	737.92	240.70	1
13	737.92	240.70	771.51	240.70	1
14	771.51	240.70	874.24	207.87	1
15	874.24	207.87	876.48	208.70	1
16	876.48	208.70	885.67	208.70	1
17	0.00	16.20	40.80	29.11	2
18	40.80	29.11	73.95	36.20	2
19	73.95	36.20	95.37	38.20	2
20	95.37	38.20	193.02	60.20	2
21	193.02	60.20	262.25	86.20	2
22	262.25	86.20	285.38	88.66	2
23	285.38	88.66	338.56	93.83	2
24	338.56	93.83	354.67	99.79	2
25	354.67	99.79	388.95	122.48	2
26	388.95	122.48	397.72	123.68	2
27	397.72	123.68	415.63	135.00	2
28	415.63	135.00	455.96	144.35	2
29	455.96	144.35	508.52	161.85	2
30	508.52	161.85	737.92	238.20	2
31	737.92	238.20	771.51	238.20	2
32	771.51	238.20	878.01	204.16	2
33	0.00	10.22	84.73	20.66	3
34	84.73	20.66	129.10	30.70	3
35	129.10	30.70	343.54	40.70	3
36	343.54	40.70	364.01	80.70	3
37	364.01	80.70	395.37	100.70	3
38	395.37	100.70	418.24	133.47	3
39	418.24	133.47	441.91	136.50	3
40	441.91	136.50	449.72	134.39	3
41	449.72	134.39	455.79	134.93	3
42	455.79	134.93	584.46	114.36	3
43	584.46	114.36	635.63	111.20	3
44	635.63	111.20	689.11	117.76	3
45	689.11	117.76	718.76	128.43	3
46	718.76	128.43	752.55	145.66	3
47	752.55	145.66	775.43	157.70	3
48	775.43	157.70	791.80	160.70	3
49	791.80	160.70	819.76	180.70	3
50	819.76	180.70	847.11	192.70	3
51	847.11	192.70	853.49	192.70	3
52	853.49	192.70	862.52	188.70	3

53	862.52	188.70	877.32	196.31	3
54	0.00	0.00	84.76	10.67	4
55	84.76	10.67	129.10	20.70	4
56	129.10	20.70	342.27	30.55	4
57	342.27	30.55	364.01	70.70	4
58	364.01	70.70	425.71	107.60	4
59	425.71	107.60	476.33	115.70	4
60	476.33	115.70	606.46	102.62	4
61	606.46	102.62	641.41	101.73	4
62	641.41	101.73	688.34	107.88	4
63	688.34	107.88	723.25	120.96	4
64	723.25	120.96	759.00	140.28	4
65	759.00	140.28	791.57	150.96	4
66	791.57	150.96	876.33	150.70	4

1

ISOTROPIC SOIL PARAMETERS

4 Type(s) of Soil

Soil Type No.	Total Unit Wt. (pcf)	Saturated Unit Wt. (pcf)	Cohesion Intercept (psf)	Friction Angle (deg)	Pore Pressure Param.	Pressure Constant (psf)	Piez. Surface No.
1	115.0	115.0	200.0	26.0	0.00	0.0	1
2	63.0	63.0	0.0	35.0	0.00	0.0	1
3	120.0	120.0	200.0	33.0	0.00	0.0	1
4	155.0	155.0	200.0	45.0	0.00	0.0	1

1

2 PIEZOMETRIC SURFACE(S) HAVE BEEN SPECIFIED

Unit Weight of Water = 62.40

Piezometric Surface No. 1 Specified by 6 Coordinate Points

Point No.	X-Water (ft)	Y-Water (ft)
1	0.00	10.22
2	1.37	11.82

3	84.47	22.14
4	128.90	32.20
5	342.54	42.16
6	343.54	40.70

Piezometric Surface No. 2 Specified by 6 Coordinate Points

Point No.	X-Water (ft)	Y-Water (ft)
1	442.13	136.44
2	455.85	136.44
3	584.63	115.85
4	635.58	112.71
5	688.76	119.23
6	721.28	129.64

A Horizontal Earthquake Loading Coefficient Of 0.300 Has Been Assigned

A Vertical Earthquake Loading Coefficient Of 0.000 Has Been Assigned

Cavitation Pressure = 0.0 (psf)

1

A Critical Failure Surface Searching Method, Using A Random Technique For Generating Circular Surfaces, Has Been Specified.

2000 Trial Surfaces Have Been Generated.

20 Surfaces Initiate From Each Of 100 Points Equally Spaced Along The Ground Surface Between X = 400.00 ft. and X = 500.00 ft.

Each Surface Terminates Between X = 700.00 ft. and X = 800.00 ft.

Unless Further Limitations Were Imposed, The Minimum Elevation

At Which A Surface Extends Is $Y = 0.00$ ft.

20.00 ft. Line Segments Define Each Trial Failure Surface.

1

Following Are Displayed The Ten Most Critical Of The Trial Failure Surfaces Examined. They Are Ordered - Most Critical First.

* * Safety Factors Are Calculated By The Modified Bishop Method * *

Failure Surface Specified By 16 Coordinate Points

Point No.	X-Surf (ft)	Y-Surf (ft)
1	464.65	149.81
2	484.42	152.83
3	504.11	156.30
4	523.72	160.23
5	543.24	164.61
6	562.65	169.45
7	581.94	174.73
8	601.10	180.46
9	620.12	186.63
10	639.00	193.25
11	657.71	200.29
12	676.26	207.77
13	694.63	215.68
14	712.81	224.02
15	730.80	232.77
16	746.17	240.70

Circle Center At $X = 344.8$; $Y = 1002.5$ and Radius, 861.1

*** 1.050 ***

Individual data on the 19 slices

Slice No.	Width (ft)	Weight (lbs)	Water	Water	Tie	Tie	Earthquake		Surcharge Load (lbs)
			Force Top (lbs)	Force Bot (lbs)	Force Norm (lbs)	Force Tan (lbs)	Force Hor (lbs)	Force Ver (lbs)	
1	14.3	2104.0	0.0	0.0	0.0	0.0	631.2	0.0	0.0
2	5.5	1801.2	0.0	0.0	0.0	0.0	540.4	0.0	0.0
3	19.7	8951.4	0.0	0.0	0.0	0.0	2685.4	0.0	0.0
4	4.4	2509.0	0.0	0.0	0.0	0.0	752.7	0.0	0.0
5	15.2	9899.7	0.0	0.0	0.0	0.0	2969.9	0.0	0.0
6	19.5	15232.1	0.0	0.0	0.0	0.0	4569.6	0.0	0.0
7	19.4	17422.4	0.0	0.0	0.0	0.0	5226.7	0.0	0.0
8	19.3	18984.5	0.0	0.0	0.0	0.0	5695.3	0.0	0.0
9	19.2	19925.8	0.0	0.0	0.0	0.0	5977.7	0.0	0.0
10	19.0	20255.6	0.0	0.0	0.0	0.0	6076.7	0.0	0.0
11	18.9	19986.0	0.0	0.0	0.0	0.0	5995.8	0.0	0.0
12	18.7	19131.0	0.0	0.0	0.0	0.0	5739.3	0.0	0.0
13	18.5	17706.6	0.0	0.0	0.0	0.0	5312.0	0.0	0.0
14	18.4	15731.4	0.0	0.0	0.0	0.0	4719.4	0.0	0.0
15	18.2	13225.7	0.0	0.0	0.0	0.0	3967.7	0.0	0.0
16	18.0	10212.0	0.0	0.0	0.0	0.0	3063.6	0.0	0.0
17	7.1	3129.8	0.0	0.0	0.0	0.0	938.9	0.0	0.0
18	3.4	1167.2	0.0	0.0	0.0	0.0	350.1	0.0	0.0
19	4.8	696.8	0.0	0.0	0.0	0.0	209.0	0.0	0.0

Failure Surface Specified By 16 Coordinate Points

Point No.	X-Surf (ft)	Y-Surf (ft)
1	469.70	151.49
2	489.58	153.62
3	509.39	156.37
4	529.11	159.74
5	548.71	163.73
6	568.17	168.34
7	587.48	173.55
8	606.61	179.36
9	625.56	185.78
10	644.29	192.78
11	662.79	200.38
12	681.05	208.55
13	699.04	217.28
14	716.74	226.58
15	734.15	236.43
16	741.16	240.70

Circle Center At X = 412.3 ; Y = 784.0 and Radius, 635.1

*** 1.052 ***

1

Failure Surface Specified By 17 Coordinate Points

Point No.	X-Surf (ft)	Y-Surf (ft)
1	447.48	144.89
2	467.34	147.22
3	487.13	150.08
4	506.85	153.45
5	526.47	157.33
6	545.98	161.73
7	565.37	166.64
8	584.62	172.05
9	603.73	177.96
10	622.67	184.37
11	641.44	191.28
12	660.02	198.67
13	678.41	206.55
14	696.58	214.90
15	714.53	223.73
16	732.23	233.03
17	745.97	240.70

Circle Center At X = 368.2 ; Y = 905.2 and Radius, 764.4

*** 1.053 ***

Failure Surface Specified By 17 Coordinate Points

Point No.	X-Surf (ft)	Y-Surf (ft)
1	451.52	145.79

2	471.43	147.65
3	491.27	150.13
4	511.03	153.23
5	530.68	156.95
6	550.21	161.28
7	569.59	166.22
8	588.81	171.76
9	607.84	177.89
10	626.68	184.62
11	645.29	191.94
12	663.67	199.83
13	681.79	208.29
14	699.64	217.32
15	717.19	226.90
16	734.44	237.02
17	740.29	240.70

Circle Center At X = 401.9 ; Y = 783.9 and Radius, 640.0

*** 1.054 ***

1

Failure Surface Specified By 17 Coordinate Points

Point No.	X-Surf (ft)	Y-Surf (ft)
1	456.57	147.13
2	476.50	148.75
3	496.37	151.01
4	516.16	153.91
5	535.85	157.44
6	555.41	161.61
7	574.82	166.40
8	594.08	171.82
9	613.15	177.85
10	632.01	184.49
11	650.65	191.74
12	669.05	199.58
13	687.19	208.01
14	705.04	217.01
15	722.60	226.59
16	739.84	236.73
17	746.12	240.70

Circle Center At X = 416.2 ; Y = 767.4 and Radius, 621.6

*** 1.055 ***

Failure Surface Specified By 16 Coordinate Points

Point No.	X-Surf (ft)	Y-Surf (ft)
1	467.68	150.82
2	487.36	154.36
3	506.97	158.30
4	526.49	162.64
5	545.92	167.38
6	565.25	172.53
7	584.47	178.06
8	603.57	183.99
9	622.54	190.32
10	641.38	197.03
11	660.08	204.13
12	678.63	211.61
13	697.02	219.47
14	715.25	227.70
15	733.30	236.31
16	742.03	240.70

Circle Center At X = 306.1 ; Y = 1107.8 and Radius, 970.5

*** 1.056 ***

1

Failure Surface Specified By 18 Coordinate Points

Point No.	X-Surf (ft)	Y-Surf (ft)
1	411.11	134.72
2	430.99	136.94

3	450.80	139.67
4	470.53	142.92
5	490.18	146.69
6	509.71	150.96
7	529.13	155.75
8	548.42	161.04
9	567.57	166.83
10	586.55	173.11
11	605.37	179.90
12	624.00	187.16
13	642.43	194.92
14	660.66	203.15
15	678.67	211.85
16	696.44	221.02
17	713.97	230.66
18	722.24	235.49

Circle Center At X = 336.3 ; Y = 896.3 and Radius, 765.2

*** 1.056 ***

Failure Surface Specified By 19 Coordinate Points

Point No.	X-Surf (ft)	Y-Surf (ft)
1	410.10	134.08
2	429.70	138.05
3	449.25	142.29
4	468.74	146.80
5	488.16	151.56
6	507.52	156.59
7	526.80	161.88
8	546.02	167.44
9	565.15	173.25
10	584.21	179.32
11	603.18	185.65
12	622.06	192.24
13	640.86	199.08
14	659.56	206.18
15	678.16	213.53
16	696.66	221.13
17	715.05	228.99
18	733.34	237.09

19 741.20 240.70

Circle Center At X = 127.1 ; Y = 1580.8 and Radius, 1474.1

*** 1.057 ***

1

Failure Surface Specified By 20 Coordinate Points

Point No.	X-Surf (ft)	Y-Surf (ft)
1	403.03	129.62
2	422.68	133.37
3	442.27	137.39
4	461.80	141.67
5	481.28	146.21
6	500.70	151.02
7	520.04	156.08
8	539.32	161.40
9	558.53	166.99
10	577.66	172.83
11	596.70	178.92
12	615.67	185.27
13	634.55	191.88
14	653.33	198.74
15	672.03	205.85
16	690.62	213.21
17	709.12	220.82
18	727.51	228.68
19	745.80	236.78
20	754.33	240.70

Circle Center At X = 133.9 ; Y = 1591.7 and Radius, 1486.7

*** 1.058 ***

Failure Surface Specified By 20 Coordinate Points

Point No.	X-Surf (ft)	Y-Surf (ft)
1	410.10	134.08
2	430.02	135.90
3	449.89	138.18
4	469.70	140.95
5	489.43	144.18
6	509.09	147.88
7	528.65	152.05
8	548.10	156.69
9	567.44	161.78
10	586.66	167.34
11	605.73	173.35
12	624.66	179.82
13	643.42	186.74
14	662.02	194.10
15	680.43	201.90
16	698.66	210.14
17	716.68	218.81
18	734.49	227.91
19	752.08	237.43
20	757.79	240.70

Circle Center At X = 344.2 ; Y = 969.3 and Radius, 837.8

*** 1.059 ***

1

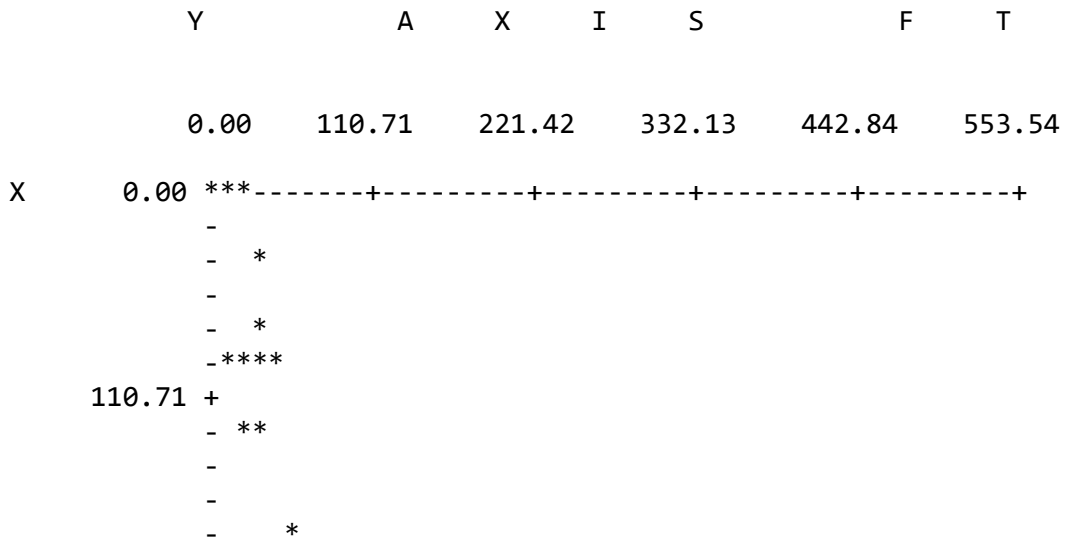

```

-      *
A  221.42 +
-
-      *
-      *
-
-
-
X  332.13 +      **
-      ** *
-      ** *
-      * *
-      . * 7
-      . * .
I  442.84 +      . . . * 3
-      . . . . * 1
-      . . . * . 41
-      . . . . . 71.
-      . . . . . 01*
-      . . . . . 21
S  553.54 +      . . . . . 01.
-      . . . . . 26
-      . . . * . . . 01.
-      . . . * . . . 16.
-      . . . * . . . 01.
-      . . . * . . . 16.
664.25 +      . . . . . 18
-      . . . ** . . . 01.
-      . . . . . 12.
-      . . ** . . . 16
-      . . . . . 1*
-      . * . . . 09
F  774.96 +      * . . . . *
-      ** . . . .
-      *
-
-      *
-      * * *
T  885.67 +      * *

```

Final Slope Stability Analysis

Circular Failure Surface, Static – Top Slope – Small

Top of Slope - Small Yarnell Slope Stability

c:\users\4163apm\desktop\project files\yarnell stability 7.0\pcstabl\top of slope - small\top of slope - small.pl2 Run By: Alex Mandeville 9/28/2018 12:35PM

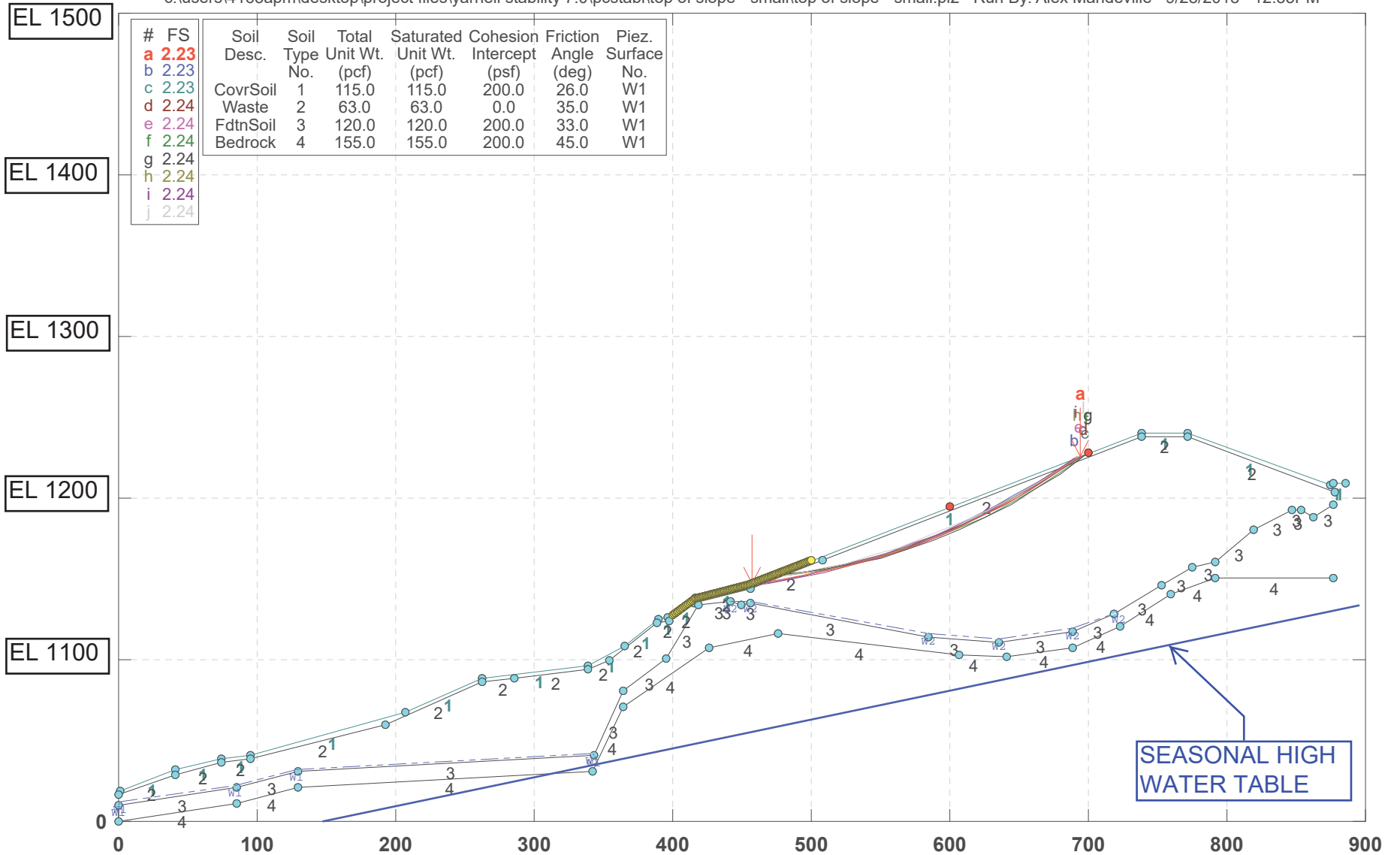

PCSTABL5M3 FSmin=2.23

Safety Factors Are Calculated By The Modified Bishop Method

** PCSTABL5M3 **

by Purdue University 1985
rev. for SCS Engineers HVA 2008

1

--Slope Stability Analysis--
Simplified Janbu, Simplified Bishop
or Spencer`s Method of Slices

Run Date: 9/28/2018
Time of Run: 12:35PM
Run By: Alex Mandeville
Input Data Filename: C:top of slope - small.in

Output Filename: C:top of slope - small.OUT

Unit: ENGLISH
Plotted Output Filename: C:top of slope - small.PLT

PROBLEM DESCRIPTION Top of Slope - Small
Yarnell Slope Stability

BOUNDARY COORDINATES

16 Top Boundaries
66 Total Boundaries

Boundary No.	X-Left (ft)	Y-Left (ft)	X-Right (ft)	Y-Right (ft)	Soil Type Below Bnd
1	0.79	19.10	40.68	31.61	1
2	40.68	31.61	73.83	38.70	1
3	73.83	38.70	95.25	40.79	1

4	95.25	40.79	207.06	67.32	1
5	207.06	67.32	262.13	88.70	1
6	262.13	88.70	338.44	96.34	1
7	338.44	96.34	365.69	108.70	1
8	365.69	108.70	389.21	125.27	1
9	389.21	125.27	396.78	125.67	1
10	396.78	125.67	416.18	137.92	1
11	416.18	137.92	454.62	146.48	1
12	454.62	146.48	737.92	240.70	1
13	737.92	240.70	771.51	240.70	1
14	771.51	240.70	874.24	207.87	1
15	874.24	207.87	876.48	208.70	1
16	876.48	208.70	885.67	208.70	1
17	0.00	16.20	40.80	29.11	2
18	40.80	29.11	73.95	36.20	2
19	73.95	36.20	95.37	38.20	2
20	95.37	38.20	193.02	60.20	2
21	193.02	60.20	262.25	86.20	2
22	262.25	86.20	285.38	88.66	2
23	285.38	88.66	338.56	93.83	2
24	338.56	93.83	354.67	99.79	2
25	354.67	99.79	388.95	122.48	2
26	388.95	122.48	397.72	123.68	2
27	397.72	123.68	415.63	135.00	2
28	415.63	135.00	455.96	144.35	2
29	455.96	144.35	508.52	161.85	2
30	508.52	161.85	737.92	238.20	2
31	737.92	238.20	771.51	238.20	2
32	771.51	238.20	878.01	204.16	2
33	0.00	10.22	84.73	20.66	3
34	84.73	20.66	129.10	30.70	3
35	129.10	30.70	343.54	40.70	3
36	343.54	40.70	364.01	80.70	3
37	364.01	80.70	395.37	100.70	3
38	395.37	100.70	418.24	133.47	3
39	418.24	133.47	441.91	136.50	3
40	441.91	136.50	449.72	134.39	3
41	449.72	134.39	455.79	134.93	3
42	455.79	134.93	584.46	114.36	3
43	584.46	114.36	635.63	111.20	3
44	635.63	111.20	689.11	117.76	3
45	689.11	117.76	718.76	128.43	3
46	718.76	128.43	752.55	145.66	3
47	752.55	145.66	775.43	157.70	3
48	775.43	157.70	791.80	160.70	3
49	791.80	160.70	819.76	180.70	3
50	819.76	180.70	847.11	192.70	3
51	847.11	192.70	853.49	192.70	3
52	853.49	192.70	862.52	188.70	3

53	862.52	188.70	877.32	196.31	3
54	0.00	0.00	84.76	10.67	4
55	84.76	10.67	129.10	20.70	4
56	129.10	20.70	342.27	30.55	4
57	342.27	30.55	364.01	70.70	4
58	364.01	70.70	425.71	107.60	4
59	425.71	107.60	476.33	115.70	4
60	476.33	115.70	606.46	102.62	4
61	606.46	102.62	641.41	101.73	4
62	641.41	101.73	688.34	107.88	4
63	688.34	107.88	723.25	120.96	4
64	723.25	120.96	759.00	140.28	4
65	759.00	140.28	791.57	150.96	4
66	791.57	150.96	876.33	150.70	4

1

ISOTROPIC SOIL PARAMETERS

4 Type(s) of Soil

Soil Type No.	Total Unit Wt. (pcf)	Saturated Unit Wt. (pcf)	Cohesion Intercept (psf)	Friction Angle (deg)	Pore Pressure Param.	Pressure Constant (psf)	Piez. Surface No.
1	115.0	115.0	200.0	26.0	0.00	0.0	1
2	63.0	63.0	0.0	35.0	0.00	0.0	1
3	120.0	120.0	200.0	33.0	0.00	0.0	1
4	155.0	155.0	200.0	45.0	0.00	0.0	1

1

2 PIEZOMETRIC SURFACE(S) HAVE BEEN SPECIFIED

Unit Weight of Water = 62.40

Piezometric Surface No. 1 Specified by 6 Coordinate Points

Point No.	X-Water (ft)	Y-Water (ft)
1	0.00	10.22
2	1.37	11.82

3	84.47	22.14
4	128.90	32.20
5	342.54	42.16
6	343.54	40.70

Piezometric Surface No. 2 Specified by 6 Coordinate Points

Point No.	X-Water (ft)	Y-Water (ft)
1	442.13	136.44
2	455.85	136.44
3	584.63	115.85
4	635.58	112.71
5	688.76	119.23
6	721.28	129.64

1

A Critical Failure Surface Searching Method, Using A Random Technique For Generating Circular Surfaces, Has Been Specified.

2000 Trial Surfaces Have Been Generated.

20 Surfaces Initiate From Each Of 100 Points Equally Spaced Along The Ground Surface Between X = 400.00 ft. and X = 500.00 ft.

Each Surface Terminates Between X = 600.00 ft. and X = 700.00 ft.

Unless Further Limitations Were Imposed, The Minimum Elevation At Which A Surface Extends Is Y = 0.00 ft.

20.00 ft. Line Segments Define Each Trial Failure Surface.

1

Following Are Displayed The Ten Most Critical Of The Trial Failure Surfaces Examined. They Are Ordered - Most Critical

First.

* * Safety Factors Are Calculated By The Modified Bishop Method * *

Failure Surface Specified By 14 Coordinate Points

Point No.	X-Surf (ft)	Y-Surf (ft)
1	457.58	147.46
2	477.47	149.51
3	497.28	152.30
4	516.96	155.83
5	536.50	160.10
6	555.86	165.11
7	575.03	170.84
8	593.96	177.28
9	612.63	184.44
10	631.03	192.29
11	649.12	200.83
12	666.87	210.04
13	684.26	219.91
14	694.54	226.27

Circle Center At X = 413.5 ; Y = 675.6 and Radius, 529.9

*** 2.231 ***

Individual data on the 16 slices

Slice No.	Width (ft)	Weight (lbs)	Water	Water	Tie	Tie	Earthquake		Surcharge Load (lbs)
			Force Top (lbs)	Force Bot (lbs)	Force Norm (lbs)	Force Tan (lbs)	Force Hor (lbs)	Force Ver (lbs)	
1	11.2	1653.3	0.0	0.0	0.0	0.0	0.0	0.0	0.0
2	8.7	3124.1	0.0	0.0	0.0	0.0	0.0	0.0	0.0
3	19.8	10714.3	0.0	0.0	0.0	0.0	0.0	0.0	0.0
4	11.2	8033.7	0.0	0.0	0.0	0.0	0.0	0.0	0.0
5	8.4	6831.0	0.0	0.0	0.0	0.0	0.0	0.0	0.0

6	19.5	17973.0	0.0	0.0	0.0	0.0	0.0	0.0	0.0	0.0
7	19.4	20041.2	0.0	0.0	0.0	0.0	0.0	0.0	0.0	0.0
8	19.2	21082.7	0.0	0.0	0.0	0.0	0.0	0.0	0.0	0.0
9	18.9	21120.8	0.0	0.0	0.0	0.0	0.0	0.0	0.0	0.0
10	18.7	20188.5	0.0	0.0	0.0	0.0	0.0	0.0	0.0	0.0
11	18.4	18328.2	0.0	0.0	0.0	0.0	0.0	0.0	0.0	0.0
12	18.1	15591.5	0.0	0.0	0.0	0.0	0.0	0.0	0.0	0.0
13	17.8	12038.5	0.0	0.0	0.0	0.0	0.0	0.0	0.0	0.0
14	17.4	7737.8	0.0	0.0	0.0	0.0	0.0	0.0	0.0	0.0
15	1.5	452.9	0.0	0.0	0.0	0.0	0.0	0.0	0.0	0.0
16	8.8	1269.4	0.0	0.0	0.0	0.0	0.0	0.0	0.0	0.0

Failure Surface Specified By 14 Coordinate Points

Point No.	X-Surf (ft)	Y-Surf (ft)
1	454.55	146.46
2	474.40	148.85
3	494.16	151.93
4	513.80	155.71
5	533.30	160.17
6	552.63	165.31
7	571.76	171.13
8	590.68	177.61
9	609.37	184.75
10	627.78	192.54
11	645.92	200.98
12	663.75	210.04
13	681.25	219.73
14	689.17	224.49

Circle Center At X = 396.8 ; Y = 712.0 and Radius, 568.5

*** 2.234 ***

1

Failure Surface Specified By 14 Coordinate Points

Point No.	X-Surf (ft)	Y-Surf (ft)
1	453.54	146.24

2	473.38	148.73
3	493.13	151.88
4	512.77	155.67
5	532.27	160.10
6	551.62	165.17
7	570.79	170.87
8	589.76	177.19
9	608.52	184.14
10	627.04	191.69
11	645.29	199.85
12	663.28	208.61
13	680.96	217.95
14	696.95	227.08

Circle Center At X = 387.5 ; Y = 751.9 and Radius, 609.2

*** 2.234 ***

Failure Surface Specified By 14 Coordinate Points

Point No.	X-Surf (ft)	Y-Surf (ft)
1	466.67	150.49
2	486.55	152.65
3	506.34	155.57
4	526.00	159.23
5	545.51	163.63
6	564.84	168.77
7	583.96	174.63
8	602.85	181.21
9	621.47	188.50
10	639.81	196.48
11	657.83	205.16
12	675.51	214.50
13	692.82	224.51
14	696.83	227.03

Circle Center At X = 419.5 ; Y = 676.5 and Radius, 528.1

*** 2.236 ***

Failure Surface Specified By 14 Coordinate Points

Point No.	X-Surf (ft)	Y-Surf (ft)
1	453.54	146.24
2	473.38	148.74
3	493.13	151.90
4	512.76	155.72
5	532.25	160.20
6	551.59	165.32
7	570.74	171.08
8	589.69	177.47
9	608.41	184.50
10	626.90	192.14
11	645.11	200.40
12	663.04	209.26
13	680.67	218.71
14	692.58	225.62

Circle Center At X = 388.7 ; Y = 741.0 and Radius, 598.3

*** 2.236 ***

Failure Surface Specified By 14 Coordinate Points

Point No.	X-Surf (ft)	Y-Surf (ft)
1	470.71	151.83
2	490.64	153.51
3	510.48	156.04
4	530.19	159.41
5	549.74	163.61
6	569.10	168.64
7	588.23	174.49
8	607.09	181.14
9	625.65	188.59
10	643.88	196.83
11	661.74	205.82

12	679.20	215.57
13	696.23	226.06
14	698.50	227.59

Circle Center At X = 441.2 ; Y = 620.8 and Radius, 469.9

*** 2.238 ***

1

Failure Surface Specified By 14 Coordinate Points

Point No.	X-Surf (ft)	Y-Surf (ft)
1	470.71	151.83
2	490.65	153.39
3	510.50	155.81
4	530.23	159.09
5	549.80	163.22
6	569.17	168.20
7	588.30	174.02
8	607.17	180.66
9	625.72	188.12
10	643.94	196.37
11	661.78	205.41
12	679.21	215.22
13	696.20	225.77
14	699.20	227.82

Circle Center At X = 445.1 ; Y = 610.4 and Radius, 459.3

*** 2.238 ***

Failure Surface Specified By 13 Coordinate Points

Point No.	X-Surf (ft)	Y-Surf (ft)
1	466.67	150.49

2	486.57	152.41
3	506.39	155.15
4	526.07	158.70
5	545.59	163.05
6	564.92	168.19
7	584.02	174.12
8	602.86	180.83
9	621.41	188.30
10	639.64	196.53
11	657.52	205.49
12	675.02	215.18
13	691.69	225.32

Circle Center At X = 429.6 ; Y = 637.9 and Radius, 488.8

*** 2.240 ***

1

Failure Surface Specified By 14 Coordinate Points

Point No.	X-Surf (ft)	Y-Surf (ft)
1	449.50	145.34
2	469.39	147.37
3	489.20	150.12
4	508.90	153.61
5	528.45	157.81
6	547.83	162.74
7	567.02	168.37
8	585.99	174.70
9	604.72	181.73
10	623.17	189.44
11	641.33	197.83
12	659.17	206.87
13	676.66	216.57
14	690.53	224.94

Circle Center At X = 404.5 ; Y = 686.2 and Radius, 542.8

*** 2.240 ***

Failure Surface Specified By 14 Coordinate Points

Point No.	X-Surf (ft)	Y-Surf (ft)
1	465.66	150.15
2	485.49	152.71
3	505.23	155.94
4	524.84	159.85
5	544.31	164.43
6	563.61	169.67
7	582.72	175.57
8	601.62	182.13
9	620.28	189.33
10	638.68	197.16
11	656.80	205.62
12	674.62	214.70
13	692.12	224.38
14	696.22	226.83

Circle Center At X = 401.4 ; Y = 728.4 and Radius, 581.8

*** 2.240 ***

1

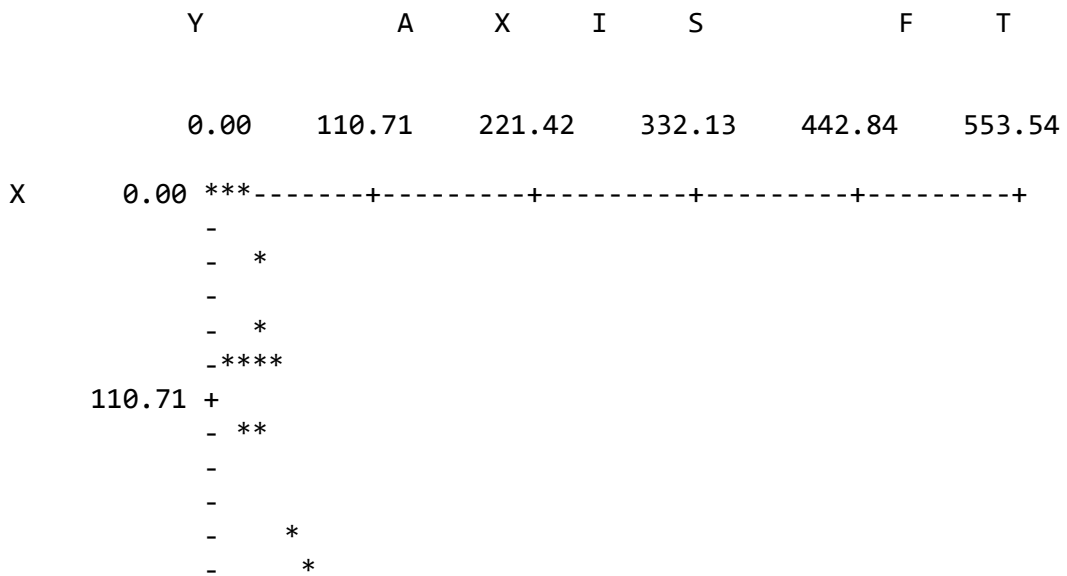

```

A 221.42 +
-
- *
- *
-
-
X 332.13 + **
- ** *
- ** *
- * *
- *
- *
- *
I 442.84 + *9
- *4
- *..21
- .....1.
- .....1*
- .....10.
S 553.54 + .....1.
- .....1..
- ..*.....1.
- ..*.....41.
- ..*.....1..
- ..*.....1.
664.25 + .....1.
- ** .....41
- .....13
- **
- *
- *
F 774.96 + *
- **
- *
- *
- *
T 885.67 + * * *
- **

```

Final Slope Stability Analysis

Circular Failure Surface, Seismic – Top Slope – Small = 0.30g

Top of Slope - Small - Seismic Yarnell Slope Stability

c:\users\4163apm\desktop\project files\yarnell stability 7.0\pcstabl\seismic - top of slope - small\top of slope - small.pl2 Run By: Alex Mandeville 9/28/2018 12:32PM

EL 1500

#	FS	Soil Desc.	Soil Type	Total Unit Wt. (pcf)	Saturated Unit Wt. (pcf)	Cohesion Intercept (psf)	Friction Angle (deg)	Piez. Surface No.	Load Horiz Eqk	Value 0.300 g<
a	1.06									
b	1.07									
c	1.07	CovrSoil	1	115.0	115.0	200.0	26.0	W1		
d	1.07	Waste	2	63.0	63.0	0.0	35.0	W1		
e	1.07	FdtnSoil	3	120.0	200.0	200.0	33.0	W1		
f	1.07	Bedrock	4	155.0	155.0	200.0	45.0	W1		
g	1.07									
h	1.07									
i	1.07									
j	1.07									

EL 1400

EL 1300

EL 1200

EL 1100

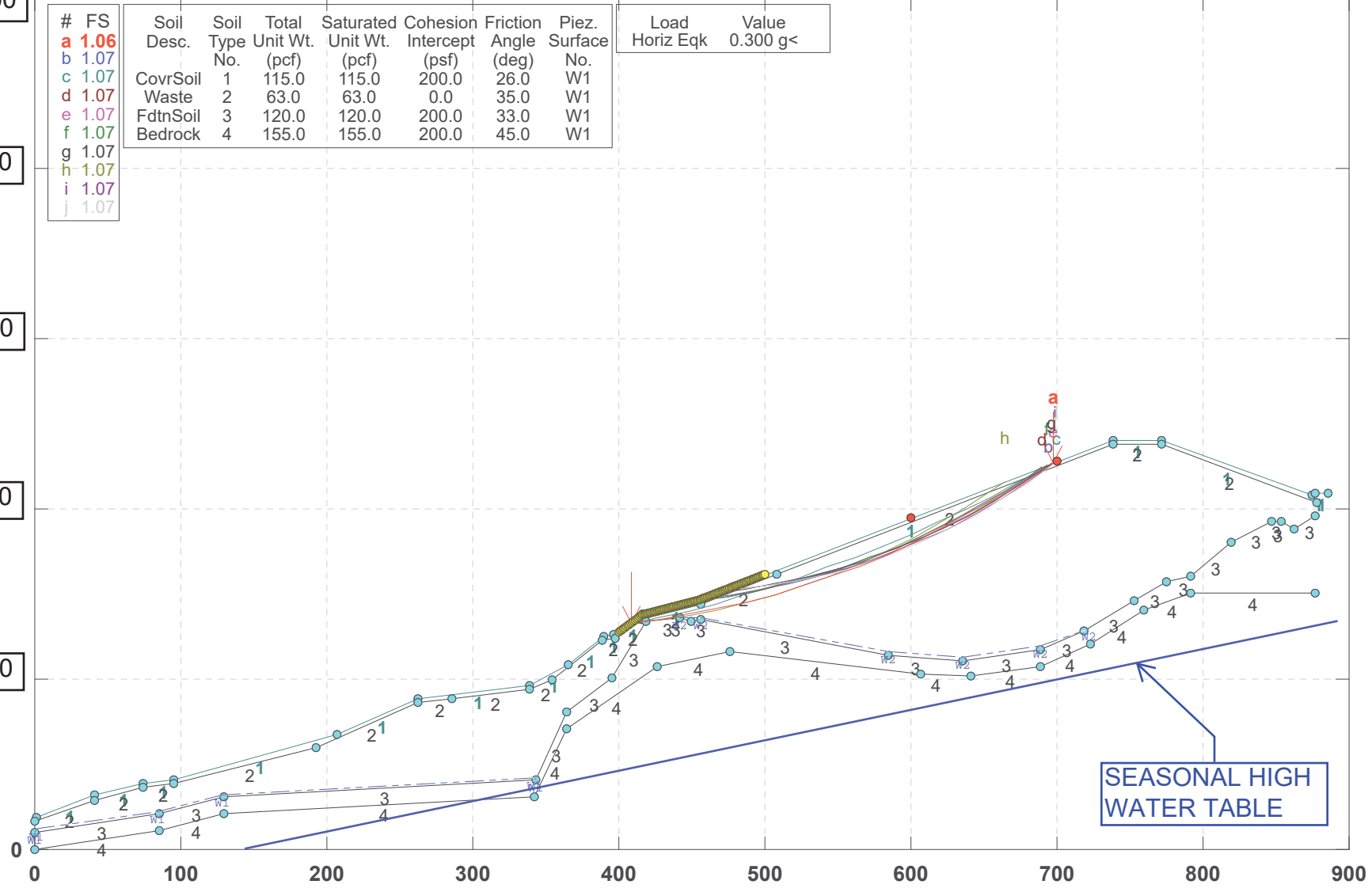

PCSTABL5M3 FSmin=1.06

Safety Factors Are Calculated By The Modified Bishop Method

SEASONAL HIGH WATER TABLE

** PCSTABL5M3 **

by Purdue University 1985
rev. for SCS Engineers HVA 2008

1

--Slope Stability Analysis--
Simplified Janbu, Simplified Bishop
or Spencer`s Method of Slices

Run Date: 9/28/2018
Time of Run: 12:32PM
Run By: Alex Mandeville
Input Data Filename: C:top of slope - small.in

Output Filename: C:top of slope - small.OUT

Unit: ENGLISH
Plotted Output Filename: C:top of slope - small.PLT

PROBLEM DESCRIPTION Top of Slope - Small - Seismic
Yarnell Slope Stability

BOUNDARY COORDINATES

16 Top Boundaries
66 Total Boundaries

Boundary No.	X-Left (ft)	Y-Left (ft)	X-Right (ft)	Y-Right (ft)	Soil Type Below Bnd
1	0.79	19.10	40.68	31.61	1
2	40.68	31.61	73.83	38.70	1
3	73.83	38.70	95.25	40.79	1

4	95.25	40.79	207.06	67.32	1
5	207.06	67.32	262.13	88.70	1
6	262.13	88.70	338.44	96.34	1
7	338.44	96.34	365.69	108.70	1
8	365.69	108.70	389.21	125.27	1
9	389.21	125.27	396.78	125.67	1
10	396.78	125.67	416.18	137.92	1
11	416.18	137.92	454.62	146.48	1
12	454.62	146.48	737.92	240.70	1
13	737.92	240.70	771.51	240.70	1
14	771.51	240.70	874.24	207.87	1
15	874.24	207.87	876.48	208.70	1
16	876.48	208.70	885.67	208.70	1
17	0.00	16.20	40.80	29.11	2
18	40.80	29.11	73.95	36.20	2
19	73.95	36.20	95.37	38.20	2
20	95.37	38.20	193.02	60.20	2
21	193.02	60.20	262.25	86.20	2
22	262.25	86.20	285.38	88.66	2
23	285.38	88.66	338.56	93.83	2
24	338.56	93.83	354.67	99.79	2
25	354.67	99.79	388.95	122.48	2
26	388.95	122.48	397.72	123.68	2
27	397.72	123.68	415.63	135.00	2
28	415.63	135.00	455.96	144.35	2
29	455.96	144.35	508.52	161.85	2
30	508.52	161.85	737.92	238.20	2
31	737.92	238.20	771.51	238.20	2
32	771.51	238.20	878.01	204.16	2
33	0.00	10.22	84.73	20.66	3
34	84.73	20.66	129.10	30.70	3
35	129.10	30.70	343.54	40.70	3
36	343.54	40.70	364.01	80.70	3
37	364.01	80.70	395.37	100.70	3
38	395.37	100.70	418.24	133.47	3
39	418.24	133.47	441.91	136.50	3
40	441.91	136.50	449.72	134.39	3
41	449.72	134.39	455.79	134.93	3
42	455.79	134.93	584.46	114.36	3
43	584.46	114.36	635.63	111.20	3
44	635.63	111.20	689.11	117.76	3
45	689.11	117.76	718.76	128.43	3
46	718.76	128.43	752.55	145.66	3
47	752.55	145.66	775.43	157.70	3
48	775.43	157.70	791.80	160.70	3
49	791.80	160.70	819.76	180.70	3
50	819.76	180.70	847.11	192.70	3
51	847.11	192.70	853.49	192.70	3
52	853.49	192.70	862.52	188.70	3

53	862.52	188.70	877.32	196.31	3
54	0.00	0.00	84.76	10.67	4
55	84.76	10.67	129.10	20.70	4
56	129.10	20.70	342.27	30.55	4
57	342.27	30.55	364.01	70.70	4
58	364.01	70.70	425.71	107.60	4
59	425.71	107.60	476.33	115.70	4
60	476.33	115.70	606.46	102.62	4
61	606.46	102.62	641.41	101.73	4
62	641.41	101.73	688.34	107.88	4
63	688.34	107.88	723.25	120.96	4
64	723.25	120.96	759.00	140.28	4
65	759.00	140.28	791.57	150.96	4
66	791.57	150.96	876.33	150.70	4

1

ISOTROPIC SOIL PARAMETERS

4 Type(s) of Soil

Soil Type No.	Total Unit Wt. (pcf)	Saturated Unit Wt. (pcf)	Cohesion Intercept (psf)	Friction Angle (deg)	Pore Pressure Param.	Pressure Constant (psf)	Piez. Surface No.
1	115.0	115.0	200.0	26.0	0.00	0.0	1
2	63.0	63.0	0.0	35.0	0.00	0.0	1
3	120.0	120.0	200.0	33.0	0.00	0.0	1
4	155.0	155.0	200.0	45.0	0.00	0.0	1

1

2 PIEZOMETRIC SURFACE(S) HAVE BEEN SPECIFIED

Unit Weight of Water = 62.40

Piezometric Surface No. 1 Specified by 6 Coordinate Points

Point No.	X-Water (ft)	Y-Water (ft)
1	0.00	10.22
2	1.37	11.82

3	84.47	22.14
4	128.90	32.20
5	342.54	42.16
6	343.54	40.70

Piezometric Surface No. 2 Specified by 6 Coordinate Points

Point No.	X-Water (ft)	Y-Water (ft)
1	442.13	136.44
2	455.85	136.44
3	584.63	115.85
4	635.58	112.71
5	688.76	119.23
6	721.28	129.64

A Horizontal Earthquake Loading Coefficient Of 0.300 Has Been Assigned

A Vertical Earthquake Loading Coefficient Of 0.000 Has Been Assigned

Cavitation Pressure = 0.0 (psf)

1

A Critical Failure Surface Searching Method, Using A Random Technique For Generating Circular Surfaces, Has Been Specified.

2000 Trial Surfaces Have Been Generated.

20 Surfaces Initiate From Each Of 100 Points Equally Spaced Along The Ground Surface Between X = 400.00 ft. and X = 500.00 ft.

Each Surface Terminates Between X = 600.00 ft. and X = 700.00 ft.

Unless Further Limitations Were Imposed, The Minimum Elevation

At Which A Surface Extends Is $Y = 0.00$ ft.

20.00 ft. Line Segments Define Each Trial Failure Surface.

1

Following Are Displayed The Ten Most Critical Of The Trial Failure Surfaces Examined. They Are Ordered - Most Critical First.

* * Safety Factors Are Calculated By The Modified Bishop Method * *

Failure Surface Specified By 17 Coordinate Points

Point No.	X-Surf (ft)	Y-Surf (ft)
1	408.08	132.81
2	427.96	135.04
3	447.76	137.84
4	467.48	141.19
5	487.09	145.11
6	506.58	149.58
7	525.94	154.60
8	545.15	160.17
9	564.19	166.28
10	583.06	172.93
11	601.72	180.12
12	620.18	187.83
13	638.40	196.06
14	656.39	204.80
15	674.12	214.05
16	691.59	223.80
17	697.23	227.17

Circle Center At $X = 339.3$; $Y = 834.2$ and Radius, 704.8

*** 1.060 ***

Individual data on the 23 slices

Slice No.	Width (ft)	Weight (lbs)	Water	Water	Tie	Tie	Earthquake		Surcharge Load (lbs)
			Force Top (lbs)	Force Bot (lbs)	Force Norm (lbs)	Force Tan (lbs)	Force Hor (lbs)	Force Ver (lbs)	
1	5.0	734.1	0.0	0.0	0.0	0.0	220.2	0.0	0.0
2	2.6	876.0	0.0	0.0	0.0	0.0	262.8	0.0	0.0
3	0.5	217.4	0.0	0.0	0.0	0.0	65.2	0.0	0.0
4	11.8	5277.4	0.0	0.0	0.0	0.0	1583.2	0.0	0.0
5	19.8	10542.4	0.0	0.0	0.0	0.0	3162.7	0.0	0.0
6	6.9	4034.8	0.0	0.0	0.0	0.0	1210.5	0.0	0.0
7	1.3	815.0	0.0	0.0	0.0	0.0	244.5	0.0	0.0
8	11.5	7799.6	0.0	0.0	0.0	0.0	2339.9	0.0	0.0
9	19.6	16043.0	0.0	0.0	0.0	0.0	4812.9	0.0	0.0
10	19.5	18775.0	0.0	0.0	0.0	0.0	5632.5	0.0	0.0
11	1.9	1997.1	0.0	0.0	0.0	0.0	599.1	0.0	0.0
12	17.4	18733.0	0.0	0.0	0.0	0.0	5619.9	0.0	0.0
13	19.2	21917.0	0.0	0.0	0.0	0.0	6575.1	0.0	0.0
14	19.0	22347.3	0.0	0.0	0.0	0.0	6704.2	0.0	0.0
15	18.9	22037.6	0.0	0.0	0.0	0.0	6611.3	0.0	0.0
16	18.7	21009.0	0.0	0.0	0.0	0.0	6302.7	0.0	0.0
17	18.5	19286.4	0.0	0.0	0.0	0.0	5785.9	0.0	0.0
18	18.2	16898.7	0.0	0.0	0.0	0.0	5069.6	0.0	0.0
19	18.0	13878.3	0.0	0.0	0.0	0.0	4163.5	0.0	0.0
20	17.7	10261.6	0.0	0.0	0.0	0.0	3078.5	0.0	0.0
21	12.9	4924.5	0.0	0.0	0.0	0.0	1477.3	0.0	0.0
22	4.5	1043.4	0.0	0.0	0.0	0.0	313.0	0.0	0.0
23	5.6	483.2	0.0	0.0	0.0	0.0	145.0	0.0	0.0

Failure Surface Specified By 14 Coordinate Points

Point No.	X-Surf (ft)	Y-Surf (ft)
1	457.58	147.46
2	477.47	149.51
3	497.28	152.30
4	516.96	155.83
5	536.50	160.10
6	555.86	165.11
7	575.03	170.84
8	593.96	177.28
9	612.63	184.44
10	631.03	192.29
11	649.12	200.83

12	666.87	210.04
13	684.26	219.91
14	694.54	226.27

Circle Center At X = 413.5 ; Y = 675.6 and Radius, 529.9

*** 1.066 ***

1

Failure Surface Specified By 17 Coordinate Points

Point No.	X-Surf (ft)	Y-Surf (ft)
1	407.07	132.17
2	426.72	135.90
3	446.30	139.98
4	465.80	144.41
5	485.22	149.19
6	504.56	154.31
7	523.79	159.78
8	542.93	165.59
9	561.96	171.74
10	580.88	178.22
11	599.68	185.05
12	618.36	192.20
13	636.90	199.69
14	655.31	207.51
15	673.58	215.65
16	691.70	224.12
17	699.38	227.88

Circle Center At X = 207.5 ; Y = 1236.4 and Radius, 1122.1

*** 1.068 ***

Failure Surface Specified By 14 Coordinate Points

Point	X-Surf	Y-Surf
-------	--------	--------

No.	(ft)	(ft)
1	454.55	146.46
2	474.40	148.85
3	494.16	151.93
4	513.80	155.71
5	533.30	160.17
6	552.63	165.31
7	571.76	171.13
8	590.68	177.61
9	609.37	184.75
10	627.78	192.54
11	645.92	200.98
12	663.75	210.04
13	681.25	219.73
14	689.17	224.49

Circle Center At X = 396.8 ; Y = 712.0 and Radius, 568.5

*** 1.068 ***

1

Failure Surface Specified By 14 Coordinate Points

Point No.	X-Surf (ft)	Y-Surf (ft)
1	453.54	146.24
2	473.38	148.73
3	493.13	151.88
4	512.77	155.67
5	532.27	160.10
6	551.62	165.17
7	570.79	170.87
8	589.76	177.19
9	608.52	184.14
10	627.04	191.69
11	645.29	199.85
12	663.28	208.61
13	680.96	217.95
14	696.95	227.08

Circle Center At X = 387.5 ; Y = 751.9 and Radius, 609.2

*** 1.068 ***

Failure Surface Specified By 14 Coordinate Points

Point No.	X-Surf (ft)	Y-Surf (ft)
1	453.54	146.24
2	473.38	148.74
3	493.13	151.90
4	512.76	155.72
5	532.25	160.20
6	551.59	165.32
7	570.74	171.08
8	589.69	177.47
9	608.41	184.50
10	626.90	192.14
11	645.11	200.40
12	663.04	209.26
13	680.67	218.71
14	692.58	225.62

Circle Center At X = 388.7 ; Y = 741.0 and Radius, 598.3

*** 1.069 ***

1

Failure Surface Specified By 14 Coordinate Points

Point No.	X-Surf (ft)	Y-Surf (ft)
1	466.67	150.49
2	486.55	152.65
3	506.34	155.57
4	526.00	159.23
5	545.51	163.63
6	564.84	168.77
7	583.96	174.63

8	602.85	181.21
9	621.47	188.50
10	639.81	196.48
11	657.83	205.16
12	675.51	214.50
13	692.82	224.51
14	696.83	227.03

Circle Center At X = 419.5 ; Y = 676.5 and Radius, 528.1

*** 1.069 ***

Failure Surface Specified By 15 Coordinate Points

Point No.	X-Surf (ft)	Y-Surf (ft)
1	408.08	132.81
2	427.98	134.81
3	447.80	137.50
4	467.52	140.85
5	487.11	144.87
6	506.55	149.56
7	525.82	154.90
8	544.91	160.89
9	563.77	167.53
10	582.40	174.81
11	600.77	182.71
12	618.86	191.24
13	636.66	200.37
14	654.13	210.11
15	664.23	216.19

Circle Center At X = 359.0 ; Y = 719.4 and Radius, 588.7

*** 1.069 ***

1

Failure Surface Specified By 14 Coordinate Points

Point No.	X-Surf (ft)	Y-Surf (ft)
1	470.71	151.83
2	490.64	153.51
3	510.48	156.04
4	530.19	159.41
5	549.74	163.61
6	569.10	168.64
7	588.23	174.49
8	607.09	181.14
9	625.65	188.59
10	643.88	196.83
11	661.74	205.82
12	679.20	215.57
13	696.23	226.06
14	698.50	227.59

Circle Center At X = 441.2 ; Y = 620.8 and Radius, 469.9

*** 1.070 ***

Failure Surface Specified By 14 Coordinate Points

Point No.	X-Surf (ft)	Y-Surf (ft)
1	470.71	151.83
2	490.65	153.39
3	510.50	155.81
4	530.23	159.09
5	549.80	163.22
6	569.17	168.20
7	588.30	174.02
8	607.17	180.66
9	625.72	188.12
10	643.94	196.37
11	661.78	205.41
12	679.21	215.22
13	696.20	225.77
14	699.20	227.82

Circle Center At X = 445.1 ; Y = 610.4 and Radius, 459.3

*** 1.071 ***

1

Y A X I S F T

0.00 110.71 221.42 332.13 442.84 553.54

```

X 0.00 ***-----+-----+-----+-----+
-
- *
-
- *
-*****
110.71 +
- **
-
-
- *
- *
A 221.42 +
-
- *
- *
-
-
X 332.13 + **
- ** *
- ** *
- * *
- .*1
- *.*.
I 442.84 + ....*3
- ....**7
- ...*..12
- .....1.
- .....2*
- .....13.
S 553.54 + .....123
- .....13.
- ..*.....1.
- .*.....12.
- .*.....1..
- *.....18

```

	664.25	+	128
		-	**11
		-		...21
		-	**	
		-		*
		-	*	
F	774.96	+	*	*
		-	**	
		-	*	
		-		*
		-	*	*
		-	*	*
T	885.67	+		**

COVER STABILITY CALCULATION (STATIC)

Project: Yarnell
Location:
Prepared by: SCS ENGINEERS
Date: Sept. 28, 2018

Calc'd by: APM Date: 9/28/2018
 Chk'd by: RHI Date: 9/28/2018

Consideration: To determine the factor of safety (FS) under static condition and residual strength, using analysis as described by Koerner and Soong (1998) referenced below.

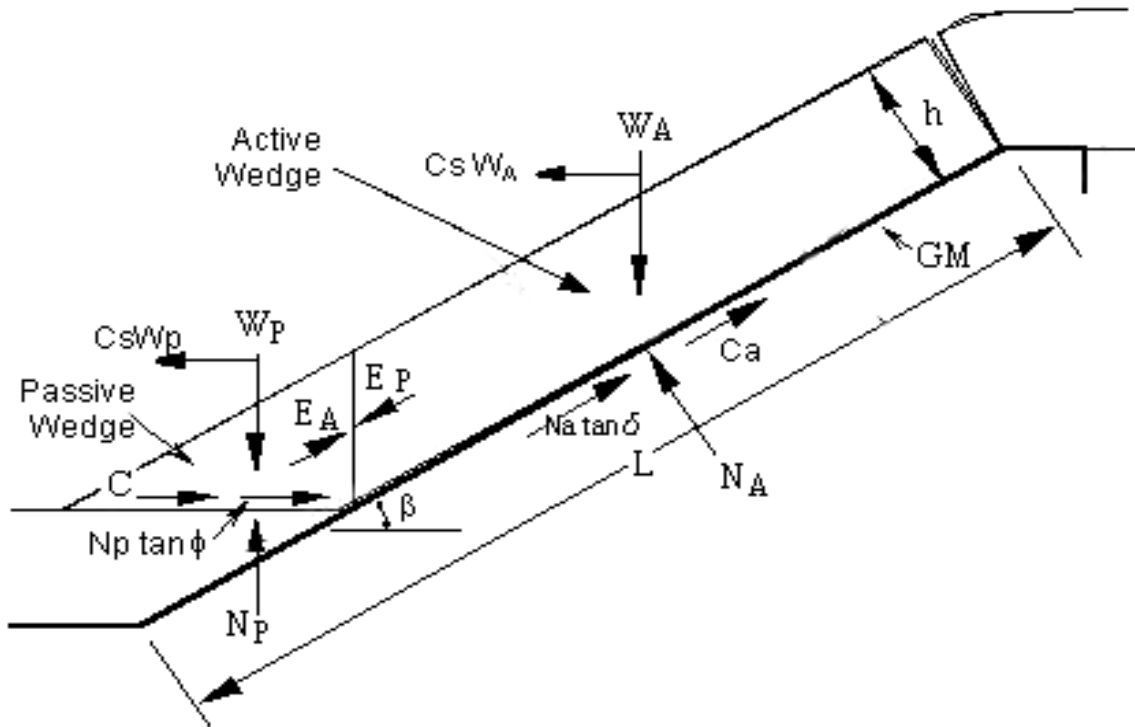

Ref.: R.M. Koerner, and T-Y. Soong, 1998. "Analysis and Design of Veneer Cover Soils". Proceeding of 6th International Conference on Geosynthetics, Vol. 1, pp. 1-23, Atlanta, Georgia, USA.

Parameters:

L	=	length of slope measured
β	=	soil slope angle
FS	=	factor of safety against instability
W_A	=	total weight of the active wedge
W_P	=	total weight of the passive wedge
N_A	=	effective force normal to the failure plane of the active wedge
h	=	thickness of the cover soil
γ	=	unit weight of the cover soil
ϕ	=	cover soil friction angle
δ	=	interface friction angle between cover soil and compacted soil barrier
C_a	=	adhesive force between cover soil of the active wedge and the soil barrier
c_a	=	adhesion between cover soil of the active wedge and the soil barrier
C	=	cohesive force along the failure plane of the passive wedge
c	=	cohesion of the cover soil

COVER STABILITY CALCULATION (STATIC)

Calculate Factor of Safety (FS):

$$FS = \frac{-b + (b^2 - 4ac)^{1/2}}{2a}, \text{ where}$$

$$a = (C_s W_A + N_A \sin \beta)(\cos \beta) + C_s W_P(\cos \beta)$$

$$b = -[(C_s W_A + N_A \sin \beta) \sin \beta (\tan \phi) + (N_A \tan \delta + C_a)(\cos^2 \beta) + (C + W_P \tan \phi) \cos \beta]$$

$$c = (N_A \tan \delta + C_a) \cos \beta \sin \beta \tan \phi, \text{ where}$$

$$W_A = \gamma h^2 [(L/h) - (1/\sin \beta) - (\tan \beta / 2)]$$

$$N_A = W_A (\cos \beta)$$

$$W_P = \gamma h^2 / \sin 2\beta$$

$$C_a = c_a (L - (h/\sin \beta))$$

$$C = (ch)/(\sin \beta)$$

$\gamma =$	18.00	kN/m ³	
$h =$	610.00	mm	= 0.61 m
$L =$	91.44	m	
$\beta =$	18.40	°	= 0.32 rad
$C_s =$	0.00	g	
$\phi =$	26.00	°	= 0.45 rad
$\delta =$	26.00	°	= 0.45 rad
$c =$	9.56	kN/m ²	
$c_a =$	0.00	kN/m ²	

$W_A =$	981.68	kN
$N_A =$	931.49	kN
$W_P =$	11.18	kN
$C_a =$	0.00	kN
$C =$	18.47	kN
$a =$	278.99	
$b =$	-477.02	
$c =$	66.37	

FS = 1.56

Summary:

At the residual interface friction angle of 26 degrees for the soil barrier interface and under static condition and no seepage force applied, the factor of safety is calculated as 1.56 indicating the final cover system is stable under the slope conditions analyzed (slope length from top to bottom of slope = 300').

APPENDIX D

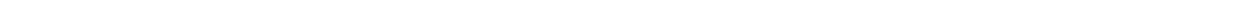

A. CLOSURE PLAN COST (SUBMIT AS PART OF CLOSURE / POST-CLOSURE PLAN)

Closure Plan

INPUT PARAMETERS

1 ft Soil/1 Acre	Cubic Yards	9.15	Line 1
Vegetative Support Layer	Feet	1	Line 2
Infiltration Layer	Feet	1.5	Line 3
Total Closure Area For F-2	Acres	9.15	Line 4

1. ENGINEERING

A. Preparation of Construction Drawings (Lump Sum)	\$15,000	Line 6
B. Preparation of Bid Specifications (Lump Sum)	\$10,000	Line 7
C. Total Cost For Construction Drawings & Bid Specs	\$25,000	Line 8

2. CONSTRUCTION OF THE FINAL COVER

A. Vegetative Support Layer Component of the Final Cover System

Offsite Topsoil:

a. Quantity Needed (yd ³)	15,000	Line 9
b. Purchase of Topsoil (\$/yr ³)	\$4.00	Line 10
c. Transportation Unit Cost (\$/yd ³)	\$0.50	Line 11
d. Total Cost of Soil ((a. * (b. + c.))	\$67,500.00	Line 12
e. Placement/Spreading Unit Cost (\$/yd ³)	\$1.75	Line 13
f. Placement Cost (a. * e.)	\$26,250.00	Line 14
g. Total Top Soil (d. + f.)	\$93,750.00	Line 15

Onsite Topsoil:

a. Quantity Needed (yd ³)	0	Line 16
b. Purchase of Topsoil (\$/yr ³)	\$0.00	Line 17
c. Transportation Unit Cost (\$/yd ³)	\$0.50	Line 18
d. Total Cost of Soil ((a. * (b. + c.))	\$0.00	Line 19
e. Placement/Spreading Unit Cost (\$/yd ³)	\$0.00	Line 20
f. Placement Cost (a. * e.)	\$0.00	Line 21
g. Total Top Soil (d. + f.)	\$0.00	Line 22

B. Infiltration/Low Permeability Cover Component of the Landfill Cover System

1Ai 30-day On-site Soil Storage

a. Quality Needed (yd ³)	600	Line 23a
b. Procure and Placement of Soil (\$/yd ³)	\$6.50	Line 23b
c. Total Cost for 30-day Soil Storage	\$3,900	Line 23c

1A. On-Site Clay

a. Quality Needed (yd ³)	0	Line 23
b. Excavation of Soil (\$/yd ³)	\$0.00	Line 24
c. excavation Cost (a. * b.)	\$0.00	Line 25
d. Transportation Unit Cost (\$/yd ³)	\$0.00	Line 26
e. Transportation Cost (a. * d.)	\$0.00	Line 27
f. Placement/Spreading Unit Cost (\$/yd ³)	\$0.00	Line 28
g. Placement Cost (a. * f.)	\$0.00	Line 29
h. Compaction Unit Cost (\$/yd ³)	\$0.00	Line 30
i. Compaction Cost (a. * h.)	\$0	Line 31
j. Total On-Site Clay (c. + e. + g. + i.)	\$0	Line 32

1B. Off-Site Clay

a. Quality Needed (yd ³)	22,000	Line 33
b. Purchase of Soil (\$/yd ³)	\$6.00	Line 34
c. Purchase Costs (a. * b.)	\$132,000.00	Line 35
d. Transportation Unit Cost (\$/yd ³)	\$0.50	Line 36
e. Transportation Cost (a. * d.)	\$11,000.00	Line 37
f. Placement/Spreading Unit Cost (\$/yd ³)	\$2.00	Line 38

A. CLOSURE PLAN COST (SUBMIT AS PART OF CLOSURE / POST-CLOSURE PLAN)

Closure Plan

g. Placement Cost (a. * f.)	\$44,000.00	Line 39
h. Compaction Unit Cost (\$/yd^3)	\$0.50	Line 40
i. Compaction Cost (a. * h.)	\$11,000	Line 41
j. Total On-Site Clay (c. + e. + g. + i.)	\$198,000	Line 42

2. Quality Control Testing of Low Permeability Clay

a. Number of Acres	9.15	Line 43
b. Sampling & Testing Costs Per Acre	\$4,250	Line 44
c. Total CQA Cost (a. * b.)	\$38,888	Line 45

Total Prepared Sub-Base Component of the Landfill Cover System (Line 42 + Line 45)	\$236,888	Line 46
--	-----------	---------

Contractor Equipment Mobilization	\$30,000	Line 47
-----------------------------------	----------	---------

Total Soil Components (Line 15+ Line 22+ Line 23c+ Line 32+ Line 42+ Line 45+ Line 47)	\$364,538	Line 48
--	-----------	---------

C. Geosynthetic Components of the Landfill Cover System - Not Applicable

1. Installation of Geosynthetic Components of Landfill Cover System

a. Number of Acres (Based on actual sqft of the final cap / surface area)	9	Line 49
b. Geocomposite Drainage Cost Per Square Foot (Installed)	\$0.00	Line 50
b1. Synthetic Membrane 50mil. With intergrated drainage structures	-	Line 51
b2. Geosynthetics (8 ounce, no-woven geotexttile)	-	Line 52
c. Geocomposite Infiltration Drainage Layer Cost / Acre (Installed)	\$0	Line 53
d. Textured 40 mil Geomembrane	\$0.00	Line 54
e. 40 mil LLDPE Cost Per Acre (installed)	\$0.00	Line 55
f. Total Geosynthetic Installation Costs (Line 53+ Line 55)	\$0.00	Line 56

2. Quality Control/Testing of Geosynthetic Components of Final Cover System

a. Number of Acres (Based on actual sqft of the final cap / surface area)	9	Line 57
b. Sampling and Testing costs per acre	\$0	Line 58
c. Labor Costs per Acre	\$0	Line 59
e. Total CQA Costs (a x (b+c))	\$0	Line 60
f. CQA Contractor Mobilization		Line 61

TOTAL COSTS OF GEOSYNTHETICS (INSTALLATION AND CQA) (Line 56 + Line 60 + Line 61)	\$0	Line 62
---	-----	---------

D. Toe Drain for Drainage of Geosynthetic Component of the Final Cover System - Not Applicable

a. Drain Unit Cost Per Foot	\$0	Line 63
b. Lineal Feet of Drain Required	-	Line 64
c. Total Cost for Toe Drain Installation (a x b)	\$0	Line 65

TOTAL COST OF CONSTRUCTION OF FINAL COVER SYSTEM (A+B+C) (Line 40+ Line 54)	\$364,538	Line 66
---	-----------	---------

3. CONSTRUCTION MANAGEMENT & ADMINISTRATION

1. Interfacing with Contractor, Owner and TDEC (Per Acre Cost)	\$2,730	Line 67
1a. Total Closure Area	9.15	Line 68
2. Total Interfacing with Contractor, Owner and TDEC (Line 67 * Line 68)	\$24,980	Line 69
3. Preparation of Documents for Final Submittal to TDEC	\$5,000	Line 70
Construction Management Total Costs (Line 69 + Line 70)	\$29,980	Line 71

4. ESTABLISHING VEGETATIVE COVER

A. Labor (\$/acre)	\$600	Line 72
B. Seeding (\$/acre)	\$1,100	Line 73
C. Fertilizing (\$/acre)	\$600	Line 74
D. Mulching (\$/acre)	\$200	Line 75
E. Number of acres (Line 4)	9.15	Line 76
TOTAL For Establ. Vegetative Cover: (Line 76 * (A+B+C+D))	\$22,875.0	Line 77

A. CLOSURE PLAN COST (SUBMIT AS PART OF CLOSURE / POST-CLOSURE PLAN)

Closure Plan

5. ESTABLISHING OR COMPLETING A SYSTEM TO MINIMIZE AND CONTROL EROSION/SEDIMENTATION

A. Sediment Pond (WILL ALREADY BE CONSTRUCTED)

B. Benches

1. Lineal feet of swale	2,400.00	Line 82
2. Earthwork per foot (\$)	\$4.00	Line 83
3. Turf Reinforcement Mat per foot (\$)	\$1.00	Line 84
Total (1. x (2. + 3.))	\$12,000.00	Line 85

C. Enhanced Silt Fence (WILL ALREADY BE CONSTRUCTED)

D. Silt Fence

E. Stormwater Control Structures for Final Cover

1. Down Chute Pipes (740 lf @ \$25/ft)	\$18,500	Line 92
2. Stormwater Sewer Pipes - 30" (300 lf @ \$35/ft)	10,500	Line 93
3. Stormwater Sewer Pipes - 24" (440 lf @ \$30/ft)	13,200	Line 93a
4. Manholes and Catch Basins - 4 manholes and 2 catch basins)	32,000	Line 93b
Total	\$74,200	Line 94

TOTAL for establishing or completing a system to minimize and control erosion and sedimentation (A. + B. + C.+ D.) **\$86,200** Line 95

6. LEACHATE COLLECTION SYSTEM - Not Applicable

A. Leachate Collection Piping and Drainage Stone Surrounding Piping (NOTE: LCS Piping Will Already Be Installed With Th Construction of the Landfill Cells)

B. Leachate Sumps (Not Applicable)

C. Lateral Drainage Media (Not Applicable)

TOTAL COST OF LEACHATE COLLECTION SYSTEM (A., B., C.) **\$0** Line 112

7. ESTABLISHING OR COMPLETING A SYSTEM TO COLLECT OR VENT GASES LANDFILL GAS COLLECTION PARAMETERS

Mobilization/Demobilization	\$2,000	Line 113
Number of LFG Wells Required for First 5 YR. Phase	10	Line 114
Gas Wells Depth (ft per well & total)	15	Line 115

A. LANDFILL GAS VENT INSTALLATION COSTS

Description:

1. Drilling/Installation Cost per Ft.	\$40	Line 116
2. Total Drill Depths [Line 114 * Line 115]	150	Line 117
3. Well Head Assembly Installation (\$/well)	\$35	Line 118
4. Costs for Well Head Installation	\$25	Line 119
LFG INSTALLATION COSTS [((Line 114 * Line 115 * Line 116) + Line 113) + Line 119]	\$8,025	Line 120

B. LANDFILL GAS SYSTEM PIPE COSTS - Not Applicable

Description:

1. Installation Cost - LFG Header (18" diameter SDR 17) (\$/LF)	\$0	Line 121
2. Length of LFG Header Pipe (FT)	-	Line 122
3. Cost Installation - Header (1. x 2.)	\$0	Line 123
1. Installation Cost - LFG Laterals (8" diameter SDR 17) (\$/LF)	\$0	Line 124
2. Length of LFG Lateral Pipe (Ft.)	-	Line 125
3. Cost Installation - Laterals (Line 124 * Line 125)	\$0	Line 126
TOTAL LFG PIPE COSTS (Line 123 + Line 126)	\$0	Line 127

C. LANDFILL GAS MISC. - Not Applicable

Description:

A. CLOSURE PLAN COST (SUBMIT AS PART OF CLOSURE / POST-CLOSURE PLAN)

Closure Plan

1. Landfill Gas Sump Installation Cost	\$0	Line 128
2. Cost - Accessories (tees, elbows, valves) 20% of total	\$0	Line 129
LFG MISC COST TOTAL (Line 128 + Line 129)	\$0	Line 130

D. LANDFILL GAS FLARE SYSTEM - Not Applicable

Description:

1. Landfill Gas Flare w Blowers	\$0	Line 131
2. Landfill Gas Generator	\$0	Line 132
LANDFILL GAS FLARE SYSTEM TOTAL (Line 131 + Line 132)	\$0	Line 133

LANDFILL GAS SYSTEM TOTAL COSTS (A. + B. + C. + D.) **\$8,025** Line 134

8. ESTABLISHING OR COMPLETING GROUNDWATER/SURFACE WATER MONITORING SYSTEM (System is Presently In-Place)

A. Installation

1. Number of wells	-	Line 135
2. Drilling cost	-	Line 136
3. Well installation oversight	-	Line 137
4. Equipment (e.g., pumps)	-	Line 138
5. Labor	-	Line 139
6. Establish surface sampling points	-	Line 140
TOTAL for establishing or completing groundwater monitoring system (1. x (2. + 3. + 4. + 5. + 6.))	\$0.00	Line 141

9. SURVEYING INSPECTIONS TO CONFIRM FINAL GRADE.

A. Transportation	\$0	Line 142
B. Labor (acre)	\$0	Line 143
C. Total Labor Costs	\$5,000	Line 144
TOTAL for surveying inspections (A. + C.)	\$5,000	Line 145

10. FIVE YEAR CLOSURE COSTS TOTAL

Sum of TOTALS For Sections (1. through 7.) **\$541,617** Line 146

SUMMARY

1. ENGINEERING		
Total Cost for Construction Drawings and Bid Specs	\$25,000	Line 8
2. CONSTRUCTION OF THE FINAL COVER SYSTEM		
TOTAL COST OF CONSTRUCTION OF FINAL COVER SYSTEM (A+B+C)	\$364,538	Line 66
3. CONSTRUCTION MANAGEMENT & ADMINISTRATION		
Construction Management Total Costs	\$29,980	Line 71
4. ESTABLISHING VEGETATIVE COVER		
TOTAL For Establ. Vegetative Cover: (A+B+C+D)	\$22,875	Line 77
5. ESTABLISHING OR COMPLETING A SYSTEM TO MINIMIZE AND CONTROL EROSION/SEDIMENTATION		
TOTAL for establishing or completing a system to minimize and control erosion and sedimentation (A. + B. + C.+ D.)	\$86,200	Line 95
6. LEACHATE COLLECTION SYSTEM		
TOTAL COST OF LEACHATE COLLECTION SYSTEM (A., B., C.)	\$0	Line 112
7. ESTABLISHING OR COMPLETING A SYSTEM TO COLLECT OR VENT GASES LANDFILL GAS COLLECTION PARAMETERS		
LANDFILL GAS SYSTEM TOTAL COSTS (A. + B. + C. + D.)	\$8,025	Line 134
8. ESTABLISHING OR COMPLETING ROUNDWATER/SURFACE WATER MONITORING SYSTEM (System is Presently In-Place)		
TOTAL for establishing or completing groundwater monitoring system (1.) x (2. + 3. + 4. + 5. + 6.)	\$0.00	Line 141
9. SURVEYING INSPECTIONS TO CONFIRM FINAL GRADE.		
TOTAL for surveying inspections (A. + C.)	\$5,000	Line 145
10. FIVE YEAR CLOSURE COSTS TOTAL		
Sum of TOTALS For Sections (1. through 9.)	\$541,617	

B. ANNUAL POST-CLOSURE PLAN COST

INPUT PARAMETERS			
CURRENT FOOTPRINT (F-1 through F-4)	ACRES =	24.34	Line 1
CLOSED AREA AS OF 2017 (F-1 and F-3) - not included in this Estimate	ACRES =	11.57	Line 2
1 FT SOIL/1 ACRE	CUBIC YARDS =	-	Line 3
VEGETATIVE SUPPORT LAYER	FEET =	-	Line 4
INFILTRATION LAYER	FEET =	-	Line 5
Volume of Leachate Based on Historical Records	GAL/YR =	2,000,000	Line 6
TOTAL CLOSURE AREA (F-2 and F-4)	ACRES =	12.77	Line 7

Notes:

1. This worksheet is to be submitted as part of the C/PC Plan.
2. This facility will be maintained and monitored for 30 years after final closure
3. Fill in blanks for all activities which apply.
4. All costs are to be calculated on an ANNUAL BASIS.

1. SURVEYING INSPECTIONS TO CONFIRM FINAL GRADE AND DRAINAGE ARE MAINTAINED.

A. Transportation (Previously Confirmed)		\$0	Line 8
B. Labor (Previously Confirmed)		\$0	Line 9
TOTAL for surveying inspections (A. + B.)		\$0	Line 10

2. MAINTAIN HEALTHY VEGETATION.

A. Transportation (local contractor No Mob charged)		\$0	Line 11
B. Labor		\$300	Line 12
C. Seeding		\$350	Line 13
D. Fertilizing		\$200	Line 14
E. Mulching		\$100	Line 15
G. Mowing		\$200	Line 16
H. Number of Acres		13.00	Line 17
TOTAL for maintaining healthy vegetation (A. + B. + C. + D. + E. + F. + G.) x (H.)		\$14,950	Line 18

3. MAINTAIN THE DRAINAGE FACILITIES, SEDIMENT PONDS AND EROSION/SEDIMENTATION CONTROL MEASURES.

1. Maintenance of Sediment Pond and Associated Erosion Control Structures

A. Trans/Equip Mob to Clean Ponds (1 Mob @ yr 2)		\$1,000	Line 19
B. Labor for Sediment Pond Maintenance		\$1,000	Line 20

C. Cleaning of Sediment Control Pond & Drainage Structures. <input checked="" type="checkbox"/>		\$3,000	Line 21
---	--	---------	---------

D. Repair of gullies or rills

a. Quantity (yd3)(estimated .5 ft of soil over 3 acres @ 4 mobs broken into an annual cost over 30 yrs)		-	Line 22
b. Purchase unit cost (\$/yd3)		-	Line 23
c. Purchase cost (a. x b.)		\$0	Line 24
d. Delivery unit cost (\$/yd3)		-	Line 25
e. Deliver cost (a. x d.)		\$0	Line 26
Total 1 (c. + e.)		\$0	Line 27

2. Placement/spreading/compaction		\$0.00	Line 28
-----------------------------------	--	--------	---------

3. Revegetation [covered in #2. MAINTAIN HEALTHY VEGETATION.]		\$0.00	Line 29
---	--	--------	---------

Total D (1. + 2. + 3.)		\$0.00	Line 30
------------------------	--	---------------	---------

Annual Total For Maintaining Drainage		\$5,000.00	Line 31
---------------------------------------	--	-------------------	---------

4. MAINTAIN AND MONITOR THE LEACHATE COLLECTION, REMOVAL, AND TREATMENT SYSTEM.

The estimate of the volume of leachate generated during Post Closure Care are taken from ground.

A. Pre-Treatment of leachate

B. ANNUAL POST-CLOSURE PLAN COST

1. Off-site Disposal		
a. Quantity (gal/year)	1,400,000	Line 32
b. Hauling unit cost (\$/gal)	\$0.00	Line 33
c. Hauling cost (a.x b.)	\$0.00	Line 34
d. Disposal unit cost (\$/gal)	\$0.100	Line 35
e. Disposal cost (a.x d.)	\$140,000	Line 36
ANNUAL TOTAL (c. + e.)	\$140,000	Line 37
ANNUAL TOTAL	\$140,000	Line 38

B. ANNUAL POST-CLOSURE PLAN COST

B. Maintenance of leachate treatment system		
1. Treatment (peroxide)	\$4,000	Line 39
2. Labor, Reporting, and Lab	\$15,000	Line 40
3. Repairs/Materials (e.g. below)		
a. Lump sum	\$0	Line 41
b. Cleaning out system	-	Line 42
c. Leak detection	\$0	Line 43
d. Leachate Analytical Testing (annual)	\$1,000	Line 44
TOTAL (a.+ b.+ c.+ d.)	\$1,000	Line 45
TOTAL	\$20,000	Line 46
TOTAL for monitoring and maintaining leachate system	\$160,000	Line 47

5. MAINTAIN AND MONITOR THE GAS VENTS		
A. Lump sum estimate	\$1,000	Line 48
B. Labor per year	\$0	Line 49
(Total Labor for Monitoring and Maintenance for LFG vents)	\$0	Line 50
C. Repairs/Materials (e.g. below)		
1. Cleaning	\$0	Line 51
2. Caps	\$0	Line 52
3. Other	\$0	Line 53
TOTAL (1.+ 2.+ 3.)	\$0	Line 54
TOTAL for maintaining/monitoring LFG system	\$1,000	Line 55

6. MAINTAIN AND MONITOR THE GROUNDWATER AND/OR SURFACE WATER MONITORING SYSTEM.		
A. Monitoring of groundwater systems:		
1. Number of wells/springs/blanks	6	Line 56
2. Number of samples/well/year	2	Line 57
3. Unit. cost of analysis	\$500	Line 58
4. Cost of sampling + analysis (1. x 2. x 3.)	\$6,000	Line 59
5. Labor cost per well per year	\$500	Line 60
6. Labor costs (1. x 5.)	\$3,000	Line 61
7. Report Preparation	\$3,000	Line 62
8. Statistical Analysis	\$2,000	Line 63
ANNUAL TOTAL (4. + 6.+ 7. + 8.)	\$14,000	Line 64
B. Inspection and maintenance of system:		
1. Lump sum estimate	1,000	Line 65
2. Labor	-	Line 66
3. Repairs/materials		
a. Caps	\$0	Line 67
b. Tubing	\$0	Line 68
c. Pumps	\$0	Line 69
d. Well Redevelopment	\$0	Line 70
e. Other	\$0	Line 71
Total (a. + b.+ c. + d. + e.)	\$0	Line 72
TOTAL B	\$1,000	Line 73
C. Sample Ancillary Spring/Surface Water Locations		
1. Annual Transportation Cost (2 trips coincide with Appendix I sample events)	\$0	Line 74
2. Labor Cost of Performing Field Parameters per Location	\$0	Line 75
3. Number of spring/surface water locations		Line 76
4. Annual Labor Costs	\$0.0	Line 77
5. Equipment Surcharge per event (\$50)	\$0	Line 78
6. Number of events per year	\$0	Line 79

B. ANNUAL POST-CLOSURE PLAN COST

TOTAL C	\$0	Line 80
---------	-----	---------

TOTAL For Maintaining and Monitoring Groundwater Systems (A+B+C)	\$15,000	Line 81
--	----------	---------

TOTAL POST CLOSURE COSTS	\$195,950	Line 82
---------------------------------	------------------	---------

SUMMARY

1. SURVEYING INSPECTIONS TO CONFIRM FINAL GRADE AND DRAINAGE ARE MAINTAINED.	\$0	Line 10
2. MAINTAIN HEALTHY VEGETATION.	\$14,950	Line 18
3. MAINTAIN THE DRAINAGE FACILITIES, SEDIMENT PONDS AND EROSION/SEDIMENTATION CONTROL MEASURES.	\$5,000	Line 31
4. MAINTAIN AND MONITOR THE LEACHATE COLLECTION, REMOVAL, AND TREATMENT SYSTEM. ☒	\$160,000	Line 47
5. MAINTAIN AND MONITOR GAS VENTS	\$1,000	Line 55
6. MAINTAIN AND MONITOR THE GROUNDWATER AND/OR SURFACE WATER MONITORING SYSTEM.	\$15,000	Line 81
TOTAL POST CLOSURE COSTS	\$195,950	Line 82

NOTE:

59 "Lines" have to be entered

23 "Lines" are automatically calculated

82